

PRODUCT MANUAL

ABB i-bus[®] KNX

SA/S x.16.5.2

Switch Actuator



Table of contents

1	About this document	6
1.1	Using the product manual	6
1.2	Legal disclaimer	6
1.3	Explanation of symbols	6
2	Safety	8
2.1	General safety instructions.....	8
2.2	Qualification of the specialist personnel.....	8
2.3	Proper use	8
3	Product overview	9
3.1	Device description	9
3.1.1	Toggle switches.....	9
3.2	Product name description	9
3.3	Ordering details	9
3.4	Connections	10
3.4.1	Inputs	10
3.4.2	Outputs	10
3.5	Switch Actuator SA/S 2.16.5.2, 2-fold, 16 A, C load, MDRC	11
3.5.1	Dimension drawing	12
3.5.2	Connection diagram	13
3.5.3	Operating and display elements	14
3.5.4	Technical data	15
3.6	Switch Actuator SA/S 4.16.5.2, 4-fold, 16 A, C load, MDRC.....	18
3.6.1	Dimension drawing	19
3.6.2	Connection diagram	20
3.6.3	Operating and display elements	21
3.6.4	Technical data	22
3.7	Switch Actuator SA/S 8.16.5.2, 8-fold, 16 A, C load, MDRC.....	25
3.7.1	Dimension drawing	26
3.7.2	Connection diagram	27
3.7.3	Operating and display elements	28
3.7.4	Technical data	29
3.8	Switch Actuator SA/S 12.16.5.2, 12-fold, 16 A, C load, MDRC.....	32
3.8.1	Dimension drawing	33
3.8.2	Connection diagram	34
3.8.3	Operating and display elements	35
3.8.4	Technical data	36
4	Function.....	39
4.1	Device functions.....	39
4.2	Software functions.....	39
4.2.1	Functional overview	39
4.2.2	Function diagram Switch Actuator.....	40
4.2.3	Safety functions.....	41
4.2.4	Function Logic	42
4.2.5	Function Threshold	43
4.2.6	Function Load shedding	45
4.2.7	Function Scenes.....	50
4.2.8	Time functions	51
4.3	Integration into i-bus® Tool.....	56
4.4	Special operating states	56
4.4.1	Reaction on bus voltage failure	56
4.4.2	Reaction after bus voltage recovery.....	56
4.4.3	Reaction on ETS reset.....	56
4.4.4	Reaction during download	57

5	Mounting and installation	58
5.1	Information about mounting	58
5.2	Mounting on mounting rail	58
6	Commissioning	59
6.1	Prerequisites for commissioning	59
6.2	Commissioning overview	59
6.3	Putting device into operation	59
6.4	Assignment of the physical address	59
6.5	Software/application	60
6.5.1	Download reaction	60
6.5.2	Copying, exchanging and converting	60
7	Parameters	61
7.1	General	61
7.2	Parameter windows	62
7.2.1	Configuration	62
7.2.2	Device settings	64
7.2.3	Safety	65
7.2.4	Logic/Threshold	66
7.2.5	Switch Actuator template	69
7.2.6	Switch Actuator X	70
7.3	Overview of parameters	81
7.4	Parameter descriptions	83
7.4.1	Number of Off/On changes	83
7.4.2	Number of flashing cycles	83
7.4.3	Recall Scene x also via 1-bit Group Object	83
7.4.4	Output reacts to	84
7.4.5	Enable output X	84
7.4.6	Delay for switching off	85
7.4.7	Monitor range between thresholds	85
7.4.8	Description	85
7.4.9	Flashing if Group Object "Flashing" is	86
7.4.10	Data point type of Group Object "Threshold input"	86
7.4.11	Request Date/Time via Group Object	87
7.4.12	Block delay for switching on and off after bus voltage recovery	87
7.4.13	Block delay for switching on and off via Group Object	87
7.4.14	Read input Group Objects after bus voltage recovery and download	88
7.4.15	Delay for switching on	89
7.4.16	Invert result	89
7.4.17	Result if upper threshold is exceeded	89
7.4.18	Result if lower threshold is dropped below	90
7.4.19	Function of the logic gate	90
7.4.20	Enable function Load shedding	92
7.4.21	Enable function Safety	92
7.4.22	Enable function Scenes [Switch Actuator]	92
7.4.23	Enable function Time	93
7.4.24	In period (0 = deactivated)	93
7.4.25	Enable Group Object "In operation"	94
7.4.26	Enable Group Object "Safety priority x"	94
7.4.27	Enable Group Object "Status Result"	94
7.4.28	Enable group object "Status Load shedding"	95
7.4.29	Enable Group Object "Request status values"	95
7.4.30	Enable Group Objects "Status Result" and "Status Input value between thresholds"	96
7.4.31	Enable Group Objects "Status byte" [Switch Actuator]	96
7.4.32	Enable Time Group Objects for setting of device time	97
7.4.33	Load shedding stage	97
7.4.34	Overwrite load shedding stage at download	98

7.4.35	Change load shedding stage via i-bus® Tool	98
7.4.36	Change load shedding stage via Group Object	99
7.4.37	Enable Logic/Threshold x-y	99
7.4.38	Maximum number of sent telegrams	99
7.4.39	Min. duration of the overshoot	100
7.4.40	Min. duration of the undershoot	100
7.4.41	Minimum dwell time between the thresholds	100
7.4.42	Upper threshold	101
7.4.43	Parameter setting	101
7.4.44	Feedback of contact position via Group Object "Status Switch"	101
7.4.45	Switch output reacts to central Switch Group Object	102
7.4.46	Switching reaction on active load shedding stage	102
7.4.47	Switching reaction on bus voltage failure	103
7.4.48	Switching reaction on revoke of load shedding stage	103
7.4.49	Switching reaction on cancellation of block, forced operation and safety priority	104
7.4.50	Switching reaction on safety priority x	104
7.4.51	Switching reaction on block	105
7.4.52	Switching reaction on forced operation	106
7.4.53	Overwrite thresholds on download	106
7.4.54	Change thresholds via i-bus® Tool	107
7.4.55	Change thresholds via Group Objects	107
7.4.56	Sending and switching delay after bus voltage recovery	108
7.4.57	Sending cycle	108
7.4.58	Read safety Group Objects after bus voltage recovery and download	108
7.4.59	Overwrite Scenes on download	109
7.4.60	Scene number	109
7.4.61	Enable Scene assignment x [Switch Actuator]	109
7.4.62	GATE blocks if Group Object "Connection A" equals	110
7.4.63	Block staircase lighting after bus voltage recovery	110
7.4.64	Switching reaction of staircase lighting on telegram value 0/1	110
7.4.65	Block staircase lighting via Group Object	111
7.4.66	Staircase lighting time	111
7.4.67	Overwrite staircase lighting time on download	111
7.4.68	Restart staircase lighting time after permanent on	112
7.4.69	Staircase lighting time can be started again	112
7.4.70	Change staircase lighting time via i-bus® Tool	113
7.4.71	Change staircase lighting time via Group Object	113
7.4.72	Staircase lighting time extendable (pumping)	114
7.4.73	Lower threshold	114
7.4.74	Reaction on result "0" [Switch Actuator]	115
7.4.75	Reaction on result "1" [Switch Actuator]	115
7.4.76	Reaction on Scene recall	116
7.4.77	Reaction of output	116
7.4.78	Reaction after flashing	117
7.4.79	Reaction after bus voltage recovery [Switch Actuator]	117
7.4.80	Reaction after ETS download [Switch Actuator]	118
7.4.81	Delay	120
7.4.82	Warning before switching off the staircase lighting	120
7.4.83	Warning time	121
7.4.84	Send value of Group Object "Status Result"	121
7.4.85	Send value of Group Object "Status Load shedding"	122
7.4.86	Value of Group Object "Status Switch"	122
7.4.87	Send value of Group Object "Status Switch"	123
7.4.88	Value of Group Object "Connection A" after bus voltage recovery	123
7.4.89	Value of Group Object "Connection B" after bus voltage recovery	124
7.4.90	Send value of Group Objects "Status byte" [Switch Actuator]	124
7.4.91	Value after sending and switching delay has expired	125
7.4.92	Send values of Group Objects "Status Result" and "Status Input value between thresholds"	125

7.4.93	Time for off	126
7.4.94	Time for on.....	126
7.4.95	Enable central Group Object "Receive load shedding stage"	126
7.4.96	Enable central Group Object "Switch".....	127
7.4.97	Enable central Group Object "Scene 1 ... 64"	127
7.4.98	i-bus® Tool access	127
7.4.99	Forced operation (1 bit / 2 bit) [Switch Actuator]	128
7.4.100	Cyclical monitoring	128
8	Group Objects	129
8.1	Overview of Group Objects.....	129
8.2	Group Objects "Central"	130
8.3	Group Objects "Safety".....	132
8.4	Group Objects Logic/Threshold X	132
8.5	Group Objects "Channel X": Switch.....	139
8.6	Group Objects "Channel X": Load shedding	143
9	Operation	144
9.1	Manual operation.....	144
10	Maintenance and cleaning.....	145
10.1	Maintenance	145
10.2	Cleaning	145
11	Removal and disposal	146
11.1	Removal	146
11.2	Environment.....	146
12	Planning and application	147
12.1	Priorities	147
12.1.1	Priorities for Switch Actuator	147
12.2	Basic knowledge	147
12.2.1	AC-1, AC-3, AC-5, AX and C load	147
12.2.2	Coding, Group Object "Receive load shedding stage".....	148
12.2.3	Coding, Group Object "Set load shedding stage"	149
12.2.4	Ballast calculation	149
12.2.5	Refreshed KNX state.....	150
12.2.6	Sending and switching delay	150
12.2.7	Telegram rate limit.....	150
12.2.8	Value Read.....	151
12.2.9	Central Group Objects.....	151
12.2.10	Cyclical monitoring	151
13	Appendix.....	152
13.1	Scope of delivery.....	152
13.2	Table of values, Group Object "Status byte all active priorities"	153
13.3	Table of values, Group Object "Scene 1 ... 64"	155

1 About this document

1.1 Using the product manual

This manual provides detailed technical information on the function, installation and programming of the ABB i-bus® KNX device.

1.2 Legal disclaimer

ABB AG reserves the right to make changes to the product or modify the contents of this document without prior notice.

The agreed properties are definitive for any orders placed. ABB AG does not accept any responsibility whatsoever for potential errors or possible lack of information in this document.

ABB AG reserves all rights in this document and in the subject matter and illustrations contained therein. Reproduction, transfer to third parties or processing of the content – including sections thereof – is not permitted without the prior written consent of ABB AG.

Copyright © 2022 ABB AG
All rights reserved

1.3 Explanation of symbols

1.	Instructions in specified sequence and result
2.	
⇒	
▶	Individual actions
a)	Priorities
1)	Processes run by the device in a specific sequence
•	List level 1
–	List level 2

Tab. 1: Explanation of symbols

Notes and warnings are represented as follows in this manual:



DANGER

This symbol is a warning about electrical voltage and indicates high-risk hazards that will definitely result in death or serious injury unless avoided.



DANGER

Indicates high-risk hazards that will definitely result in death or serious injury unless avoided.



WARNING

Indicates medium-risk hazards that could result in death or serious injury unless avoided.



CAUTION

Indicates low-risk hazards that could result in slight or moderate injury unless avoided.



CAUTION

Indicates a risk of malfunctions or damage to property and equipment, but with no risk to life and limb.

Example

For use in application, installation and programming examples

i Note

For use in tips on use and operation

2 Safety

2.1 General safety instructions

- ▶ Protect the device from moisture, dirt and damage during transport, storage and operation.
- ▶ Operate the device only in a closed housing (distribution board).
- ▶ Operate the device only within the specified technical data.
- ▶ Mounting, installation, commissioning and maintenance must be carried out only by qualified electricians.
- ▶ Disconnect device from the supply of electrical power before mounting.

2.2 Qualification of the specialist personnel

Programming the device requires detailed specialist knowledge – particularly about the ETS commissioning software – through KNX training courses.

2.3 Proper use

The SA/S Switch Actuators are intended to be used to switch electrical loads in single- or multi-phase electrical networks in a KNX environment.

3 Product overview

3.1 Device description

The devices are modular installation devices (MDRC) in *proM* design. They are designed for installation in electrical distribution boards and small housings with a 35 mm mounting rail (to EN 60715).

The devices are KNX-certified and can be used as products in a KNX system → EU declaration of conformity.

The devices are powered via the bus (ABB i-bus® KNX) and require no additional auxiliary voltage. The connection to the bus is made via a bus connection terminal on the front of the housing. The loads are connected to the outputs using screw terminals → terminal designation on the housing.

The software application Engineering Tool Software (ETS) is used for physical address assignment and parameterization.

3.1.1 Toggle switches

The toggle switches indicate the positions of the relay contacts:

- closed (I)
- open (O)

The relays for the outputs can be switched On (I) and Off (O) manually using the toggle switches. The relays can also be switched if there is a bus voltage failure and by active safety functions.

Note

If the relays are switched manually using the toggle switches, KNX operation is overridden. Manually set contact positions are not detected by the device and are not set again automatically after bus voltage recovery or after ETS download.

3.2 Product name description

Abbreviation	Description
SA	Switch Actuator
/S	MDRC
x.	2 = 2-fold
	4 = 4-fold
	8 = 8-fold
	12 = 12-fold
x.	16 = 16 A / 20 A
x.	5 = C load (200 µF)
x	x = Version number (x = 1, 2, etc.)

Tab. 2: Product name description

3.3 Ordering details

Description	MW	Type	Order no.	Packaging unit [pcs.]	Weight (incl. packaging) [kg]
Switch	2	SA/S 2.16.5.2	2CDG110265R0011	1	0.21
Switch	4	SA/S 4.16.5.2	2CDG110266R0011	1	0.31
Switch	8	SA/S 8.16.5.2	2CDG110267R0011	1	0.55
Switch	12	SA/S 12.16.5.2	2CDG110268R0011	1	0.79

Tab. 3: Ordering details

3.4 Connections

The devices possess the following connections:

- Depending on the device type, 2, 4, 8 or 12 relay outputs for switching electrical loads
- 1 bus connection

3.4.1 Inputs

This section is not relevant for these devices.

3.4.2 Outputs

i Note

A device with 12 channels (A ... L) is described below.

The outputs can be used individually to switch electrical loads.

Function	A	B	C	D	E	F	G	H	I	J	K	L
Switch	x	x	x	x	x	x	x	x	x	x	x	x

Tab. 4: Functions of the outputs

3.5 Switch Actuator SA/S 2.16.5.2, 2-fold, 16 A, C load, MDRC

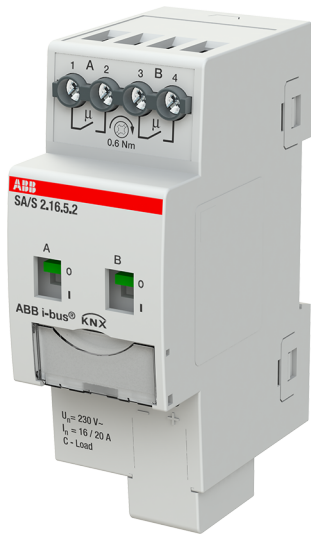

Fig. 1: Device illustration SA/S 2.16.5.2

3.5.1 Dimension drawing

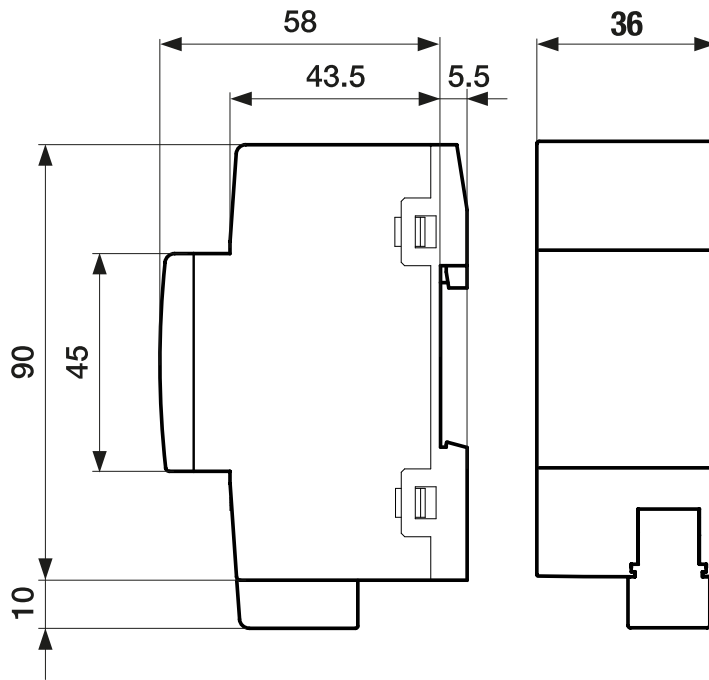

Fig. 2: Dimension drawing

2CDC072025F0017

3.5.2 Connection diagram

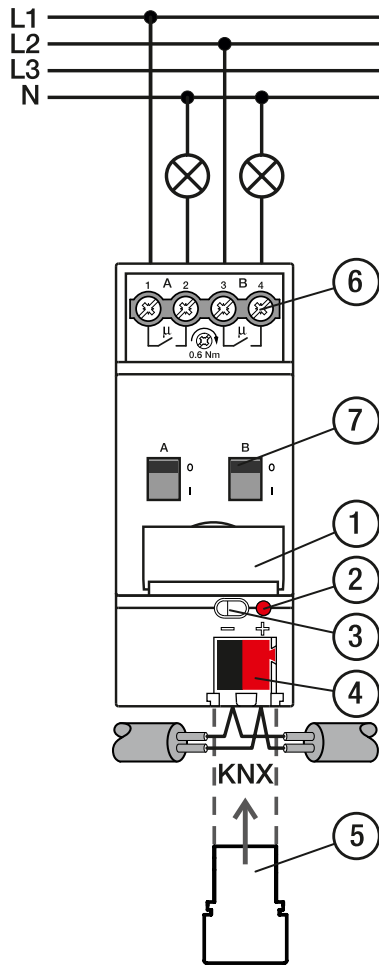



Fig. 3: Connection diagram SA/S 2.x.x.2

—
Legend

- 1 label carrier
- 2 *Programming* LED
- 3 *Programming* button
- 4 Bus connection terminal

- 5 Cover cap
- 6 Load circuit, two screw terminals each
- 7 Toggle switches

3.5.3 Operating and display elements

Operating control/LED	Description/function	Display
	Assignment of the physical address	LED On: Device in programming mode
<i>Programming button/LED</i>		
	Switching of the output: <ul style="list-style-type: none"> • 1 = Switch on • 0 = Switch off 	Indication of the contact position: <ul style="list-style-type: none"> • 1 = Closed • 0 = Open
Toggle switches		

Tab. 5: Operating and display elements

3.5.4 Technical data

3.5.4.1 General technical data

Device	Dimensions	90 × 36 × 63.5 mm (H × W × D)
	Mounting width in space units	2 modules, 17.5 mm each
	Weight	0.14 kg
	Mounting position	Any
	Mounting variant	35 mm mounting rail
	Design	proM
	Degree of protection	IP 54
	Protection class	II
	Overvoltage category	III
	Pollution degree	2
Materials	Housing	Polycarbonate, Makrolon FR6002, halogen free
Material note	Fire classification	Flammability V-0
Electronics	Rated voltage, bus	30 V DC
	Voltage range, bus	21 ... 31 V DC
	Current consumption, bus	< 12 mA
	Maximum current, device	2 × 20 A
	Power loss, device	≤ 2 W (16 A)/3 W (20 A)
	Power loss, bus	≤ 0.25 W
	KNX safety extra low voltage	SELV
Connections	Connection type, KNX bus	Plug-in terminal
	Cable diameter, KNX bus	0.6 ... 0.8 mm, solid
	Connection type, load circuit	Screw terminal with universal head (PZ 1)
	Pitch	7.62 mm
	Tightening torque, screw terminals	0.5 ... 0.6 Nm
	Conductor cross-section, flexible	1 × (0.2 ... 4 mm ²) / 2 × (0.2 ... 2.5 mm ²)
	Conductor cross section, rigid	1 × (0.2 ... 6 mm ²) / 2 × (0.2 ... 4 mm ²)
	Conductor cross section with wire end ferrule without plastic sleeve	1 × (0.25 ... 2.5 mm ²)
	Conductor cross section with wire end ferrule with plastic sleeve	1 × (0.25 ... 4 mm ²)
	Conductor cross section with TWIN wire end ferrule	1 × (0.5 ... 2.5 mm ²)
Length, wire end ferrule contact pin	≥ 10 mm	
Certificates and declarations	Declaration of conformity CE	→ 2CDK505253D2701
Ambient conditions	Operation	-5 ... +45 °C
	Transport	-25 ... +70 °C
	Storage	-25 ... +55 °C
	Humidity	≤ 95 %
	Condensation allowed	No
	Atmospheric pressure	≥ 80 kPa (corresponds to air pressure at 2,000 m above sea level)

Tab. 6: General technical data

3.5.4.2 Outputs – relays 16 A - 20 A (C load)







Rated values	Number of outputs	2
	Rated voltage U_n	230 V AC
	Rated current I_n (per output)	16/20 A
	Rated frequency	50/60 Hz
	Relay type	Bi-stable
Switching currents	AC-1 operation ($\cos \varphi = 0.8$)	≤ 20 A
	AC-3 operation ($\cos \varphi = 0.45$)	≤ 16 A
	Fluorescent lighting load AX	≤ 20 AX
	Switching current at 12 V AC	≥ 0.1 A
	Switching current at 24 V AC	≥ 0.1 A
Service life	Switching current at 24 V DC (resistive load)	≤ 20 A
	Mechanical service life	$\geq 10^6$ switching operations
	AC-1 operation ($\cos \varphi = 0.8$)	$\geq 10^5$ switching operations
	AC-3 operation ($\cos \varphi = 0.45$)	$\geq 3 \times 10^4$ switching operations
	AC-5a operation ($\cos \varphi = 0.45$)	$\geq 3 \times 10^4$ switching operations
Switching operations	Switching operations per minute when one relay switches	≤ 60
	Switching operations per minute when all relays switch	≤ 30
Starting current	Starting current I_{peak} (150 μ s)	≤ 600 A
	Starting current I_{peak} (250 μ s)	≤ 480 A
	Starting current I_{peak} (600 μ s)	≤ 300 A

Tab. 7: Outputs – relays 16 A – 20 A (C load)

i Note

The starting current I_{peak} is the typical ballast load current that results during switching. Using the starting current I_{peak} , it is possible to calculate the maximum number of switchable ballasts at the Switch Actuator output → [Ballast calculation, Page 149](#).

3.5.4.2.1 Load table

Load type	Symbol	Max. load
Incandescent bulbs		3680 W
Fluorescent lamps uncompensated		3680 W
Fluorescent lamps parallel compensated		2500 W
Fluorescent lamps duo circuit		3680 W
Low-voltage halogen lamps inductive transformer		2000 W
Low-voltage halogen lamps electronic transformer		2500 W
Low-voltage halogen lamps 230 V		3680 W
Dulux lamps uncompensated		3680 W
Dulux lamps parallel compensated		3000 W
Mercury-vapor lamps uncompensated		3680 W
Mercury-vapor lamps parallel compensated		3000 W
LED lamps		650 W
Rated motor power		3680 W

Tab. 8: Load table

3.5.4.3 Device type

Device type	Switch Actuator	SA/S 2.16.5.2
	Application	Switch C load 2-fold 16 A / ...
		... = current version number of the application
	Maximum number of Group Objects	136
	Maximum number of group addresses	1000
	Maximum number of assignments	1000

Tab. 8: Device type

i Note

Observe software information on the website → www.abb.com/knx.

i Note

The device may be protected with a BCU key in ETS. If a BCU key was assigned, the device cannot be read or programmed without it.

3.6 Switch Actuator SA/S 4.16.5.2, 4-fold, 16 A, C load, MDRC



Fig. 4: Device illustration SA/S 4.16.5.2

9PAA00000007977-Rev_A

3.6.1 Dimension drawing

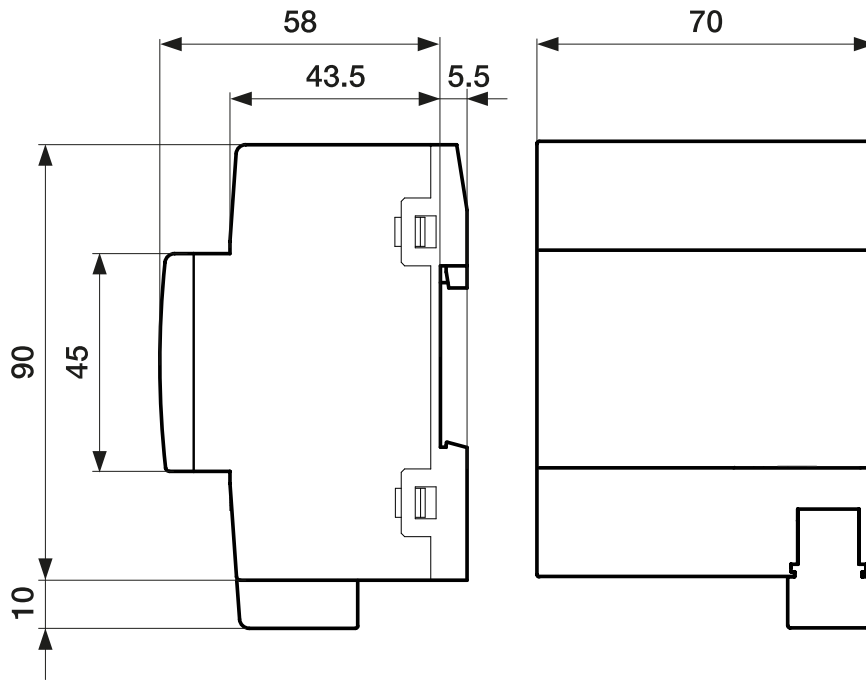

Fig. 5: Dimension drawing

2CDC072033F0015

3.6.2 Connection diagram

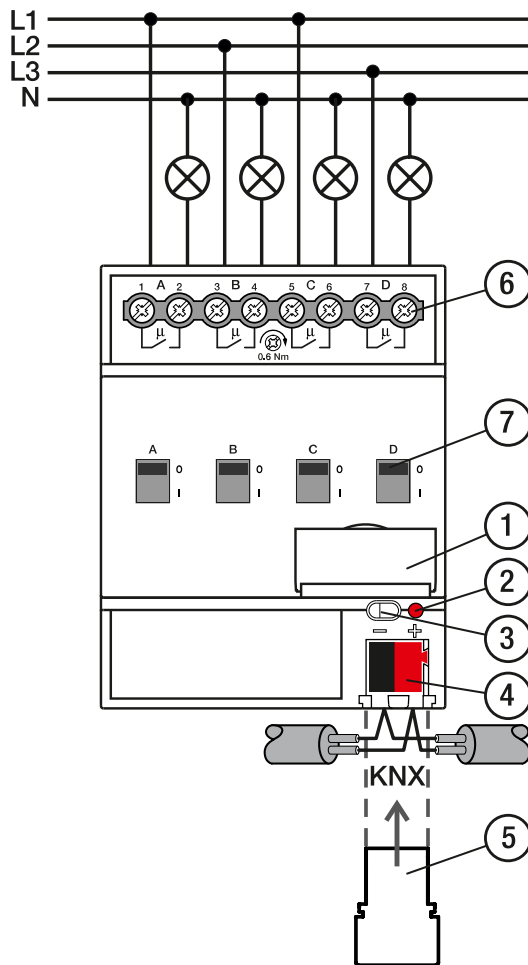



Fig. 6: Connection diagram SA/S 4.x.x.2

—
Legend

- | | |
|-----------------------------|--|
| 1 label carrier | 5 Cover cap |
| 2 <i>Programming</i> LED | 6 Load circuit, two screw terminals each |
| 3 <i>Programming</i> button | 7 Toggle switches |
| 4 Bus connection terminal | |

2CDC072003F0019

3.6.3 Operating and display elements

Operating control/LED	Description/function	Display
	Assignment of the physical address	LED On: Device in programming mode
<i>Programming button/LED</i>		
	Switching of the output: <ul style="list-style-type: none"> • 1 = Switch on • 0 = Switch off 	Indication of the contact position: <ul style="list-style-type: none"> • 1 = Closed • 0 = Open
Toggle switches		

Tab. 9: Operating and display elements

3.6.4 Technical data

3.6.4.1 General technical data

Device	Dimensions	90 × 70 × 63.5 mm (H × W × D)
	Mounting width in space units	4 modules, 17.5 mm each
	Weight	0.24 kg
	Mounting position	Any
	Mounting variant	35 mm mounting rail
	Design	proM
	Degree of protection	IP 54
	Protection class	II
	Overvoltage category	III
	Pollution degree	2
Materials	Housing	Polycarbonate, Makrolon FR6002, halogen free
Material note	Fire classification	Flammability V-0
Electronics	Rated voltage, bus	30 V DC
	Voltage range, bus	21 ... 31 V DC
	Current consumption, bus	< 12 mA
	Maximum current, device	4 × 20 A
	Power loss, device	≤ 4 W (16 A)/5.5 W (20 A)
	Power loss, bus	≤ 0.25 W
	KNX safety extra low voltage	SELV
Connections	Connection type, KNX bus	Plug-in terminal
	Cable diameter, KNX bus	0.6 ... 0.8 mm, solid
	Connection type, load circuit	Screw terminal with universal head (PZ 1)
	Pitch	7.62 mm
	Tightening torque, screw terminals	0.5 ... 0.6 Nm
	Conductor cross-section, flexible	1 × (0.2 ... 4 mm ²) / 2 × (0.2 ... 2.5 mm ²)
	Conductor cross section, rigid	1 × (0.2 ... 6 mm ²) / 2 × (0.2 ... 4 mm ²)
	Conductor cross section with wire end ferrule without plastic sleeve	1 × (0.25 ... 2.5 mm ²)
	Conductor cross section with wire end ferrule with plastic sleeve	1 × (0.25 ... 4 mm ²)
	Conductor cross section with TWIN wire end ferrule	1 × (0.5 ... 2.5 mm ²)
Length, wire end ferrule contact pin	≥ 10 mm	
Certificates and declarations	Declaration of conformity CE	→ 2CDK505243D2701
Ambient conditions	Operation	-5 ... +45 °C
	Transport	-25 ... +70 °C
	Storage	-25 ... +55 °C
	Humidity	≤ 95 %
	Condensation allowed	No
	Atmospheric pressure	≥ 80 kPa (corresponds to air pressure at 2,000 m above sea level)

Tab. 10: General technical data

3.6.4.2 Outputs – relays 16 A - 20 A (C load)







Rated values	Number of outputs	4
	Rated voltage U_n	230 V AC
	Rated current I_n (per output)	16/20 A
	Rated frequency	50/60 Hz
	Relay type	Bi-stable
Switching currents	AC-1 operation ($\cos \varphi = 0.8$)	≤ 20 A
	AC-3 operation ($\cos \varphi = 0.45$)	≤ 16 A
	Fluorescent lighting load AX	≤ 20 AX
	Switching current at 12 V AC	≥ 0.1 A
	Switching current at 24 V AC	≥ 0.1 A
Service life	Switching current at 24 V DC (resistive load)	≤ 20 A
	Mechanical service life	$\geq 10^6$ switching operations
	AC-1 operation ($\cos \varphi = 0.8$)	$\geq 10^5$ switching operations
	AC-3 operation ($\cos \varphi = 0.45$)	$\geq 3 \times 10^4$ switching operations
	AC-5a operation ($\cos \varphi = 0.45$)	$\geq 3 \times 10^4$ switching operations
Switching operations	Switching operations per minute when one relay switches	≤ 60
	Switching operations per minute when all relays switch	≤ 15
Starting current	Starting current I_{peak} (150 μ s)	≤ 600 A
	Starting current I_{peak} (250 μ s)	≤ 480 A
	Starting current I_{peak} (600 μ s)	≤ 300 A

Tab. 11: Outputs – relays 16 A – 20 A (C load)

i Note

The starting current I_{peak} is the typical ballast load current that results during switching. Using the starting current I_{peak} , it is possible to calculate the maximum number of switchable ballasts at the Switch Actuator output → [Ballast calculation, Page 149](#).

3.6.4.2.1 Load table

Load type	Symbol	Max. load
Incandescent bulbs		3680 W
Fluorescent lamps uncompensated		3680 W
Fluorescent lamps parallel compensated		2500 W
Fluorescent lamps duo circuit		3680 W
Low-voltage halogen lamps inductive transformer		2000 W
Low-voltage halogen lamps electronic transformer		2500 W
Low-voltage halogen lamps 230 V		3680 W
Dulux lamps uncompensated		3680 W
Dulux lamps parallel compensated		3000 W
Mercury-vapor lamps uncompensated		3680 W
Mercury-vapor lamps parallel compensated		3000 W
LED lamps		650 W
Rated motor power		3680 W

Tab. 13: Load table

3.6.4.3 Device type

Device type	Switch Actuator	SA/S 4.16.5.2
	Application	Switch C load 4-fold 16 A / ...
		... = current version number of the application
	Maximum number of Group Objects	166
	Maximum number of group addresses	1000
	Maximum number of assignments	1000

Tab. 12: Device type

i Note

Observe software information on the website → www.abb.com/knx.

i Note

The device may be protected with a BCU key in ETS. If a BCU key was assigned, the device cannot be read or programmed without it.

3.7 Switch Actuator SA/S 8.16.5.2, 8-fold, 16 A, C load, MDRC



Fig. 7: Device illustration SA/S 8.16.5.2

9PAA0000007994-Rev_A

3.7.1 Dimension drawing

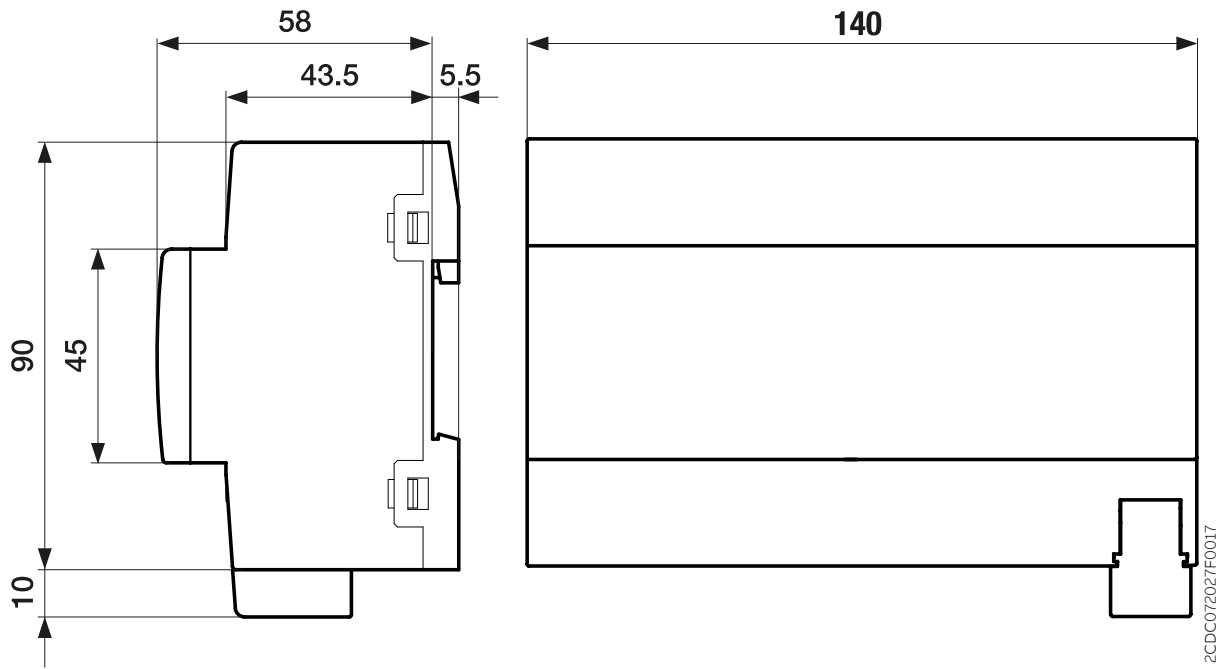

Fig. 8: Dimension drawing

3.7.2 Connection diagram

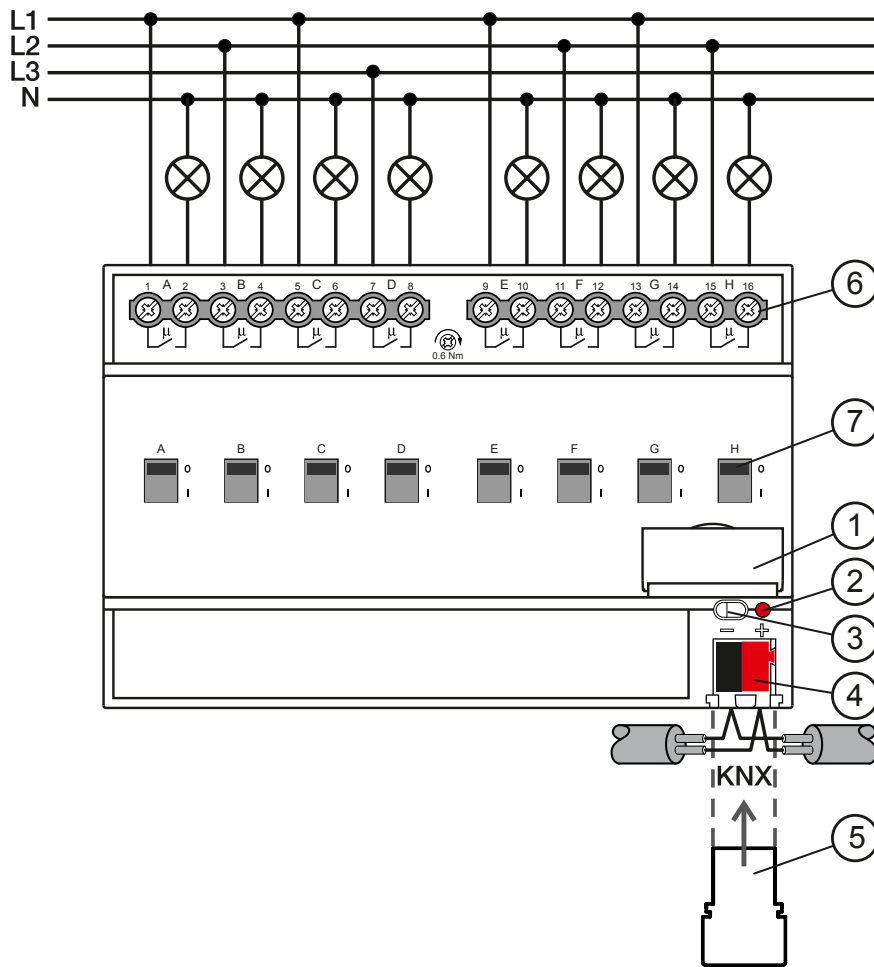



Fig. 9: Connection diagram SA/S 8.x.x.2

Legend

- 1 label carrier
- 2 *Programming* LED
- 3 *Programming* button
- 4 Bus connection terminal
- 5 Cover cap
- 6 Load circuit, two screw terminals each
- 7 Toggle switches

3.7.3 Operating and display elements

Operating control/LED	Description/function	Display
	Assignment of the physical address	LED On: Device in programming mode
<i>Programming button/LED</i>		
	Switching of the output: <ul style="list-style-type: none"> • 1 = Switch on • 0 = Switch off 	Indication of the contact position: <ul style="list-style-type: none"> • 1 = Closed • 0 = Open
Toggle switches		

Tab. 13: Operating and display elements

3.7.4 Technical data

3.7.4.1 General technical data

Device	Dimensions	90 × 140 × 63.5 mm (H x W x D)
	Mounting width in space units	8 modules, 17.5 mm each
	Weight	0.45 kg
	Mounting position	Any
	Mounting variant	35 mm mounting rail
	Design	proM
	Degree of protection	IP 54
	Protection class	II
	Overvoltage category	III
	Pollution degree	2
Materials	Housing	Polycarbonate, Makrolon FR6002, halogen free
Material note	Fire classification	Flammability V-0
Electronics	Rated voltage, bus	30 V DC
	Voltage range, bus	21 ... 31 V DC
	Current consumption, bus	< 12 mA
	Maximum current, device	8 × 20 A
	Power loss, device	≤ 8 W (16 A)/20 W (20 A)
	Power loss, bus	≤ 0.25 W
	KNX safety extra low voltage	SELV
Connections	Connection type, KNX bus	Plug-in terminal
	Cable diameter, KNX bus	0.6 ... 0.8 mm, solid
	Connection type, load circuit	Screw terminal with universal head (PZ 1)
	Pitch	7.62 mm
	Tightening torque, screw terminals	0.5 ... 0.6 Nm
	Conductor cross-section, flexible	1 × (0.2 ... 4 mm ²) / 2 × (0.2 ... 2.5 mm ²)
	Conductor cross section, rigid	1 × (0.2 ... 6 mm ²) / 2 × (0.2 ... 4 mm ²)
	Conductor cross section with wire end ferrule without plastic sleeve	1 × (0.25 ... 2.5 mm ²)
	Conductor cross section with wire end ferrule with plastic sleeve	1 × (0.25 ... 4 mm ²)
	Conductor cross section with TWIN wire end ferrule	1 × (0.5 ... 2.5 mm ²)
Length, wire end ferrule contact pin	≥ 10 mm	
Certificates and declarations	Declaration of conformity CE	→ 2CDK505244D2701
Ambient conditions	Operation	-5 ... +45 °C
	Transport	-25 ... +70 °C
	Storage	-25 ... +55 °C
	Humidity	≤ 95 %
	Condensation allowed	No
	Atmospheric pressure	≥ 80 kPa (corresponds to air pressure at 2,000 m above sea level)

Tab. 14: General technical data

3.7.4.2 Outputs – relays 16 A - 20 A (C load)







Rated values	Number of outputs	8
	Rated voltage U_n	230 V AC
	Rated current I_n (per output)	16/20 A
	Rated frequency	50/60 Hz
	Relay type	Bi-stable
Switching currents	AC-1 operation ($\cos \varphi = 0.8$)	≤ 20 A
	AC-3 operation ($\cos \varphi = 0.45$)	≤ 16 A
	Fluorescent lighting load AX	≤ 20 AX
	Switching current at 12 V AC	≥ 0.1 A
	Switching current at 24 V AC	≥ 0.1 A
Service life	Switching current at 24 V DC (resistive load)	≤ 20 A
	Mechanical service life	$\geq 10^6$ switching operations
	AC-1 operation ($\cos \varphi = 0.8$)	$\geq 10^5$ switching operations
	AC-3 operation ($\cos \varphi = 0.45$)	$\geq 3 \times 10^4$ switching operations
	AC-5a operation ($\cos \varphi = 0.45$)	$\geq 3 \times 10^4$ switching operations
Switching operations	Switching operations per minute when one relay switches	≤ 60
	Switching operations per minute when all relays switch	≤ 7
Starting current	Starting current I_{peak} (150 μ s)	≤ 600 A
	Starting current I_{peak} (250 μ s)	≤ 480 A
	Starting current I_{peak} (600 μ s)	≤ 300 A

Tab. 15: Outputs – relays 16 A – 20 A (C load)

Note

The starting current I_{peak} is the typical ballast load current that results during switching. Using the starting current I_{peak} , it is possible to calculate the maximum number of switchable ballasts at the Switch Actuator output → [Ballast calculation, Page 149](#).

3.7.4.2.1 Load table

Load type	Symbol	Max. load
Incandescent bulbs		3680 W
Fluorescent lamps uncompensated		3680 W
Fluorescent lamps parallel compensated		2500 W
Fluorescent lamps duo circuit		3680 W
Low-voltage halogen lamps inductive transformer		2000 W
Low-voltage halogen lamps electronic transformer		2500 W
Low-voltage halogen lamps 230 V		3680 W
Dulux lamps uncompensated		3680 W
Dulux lamps parallel compensated		3000 W
Mercury-vapor lamps uncompensated		3680 W
Mercury-vapor lamps parallel compensated		3000 W
LED lamps		650 W
Rated motor power		3680 W

Tab. 18: Load table

3.7.4.3 Device type

Device type	Switch Actuator	SA/S 8.16.5.2
	Application	Switch C load 8-fold 16 A / ...
		... = current version number of the application
	Maximum number of Group Objects	226
	Maximum number of group addresses	1000
	Maximum number of assignments	1000

Tab. 16: Device type

i Note

Observe software information on the website → www.abb.com/knx.

i Note

The device may be protected with a BCU key in ETS. If a BCU key was assigned, the device cannot be read or programmed without it.

3.8 Switch Actuator SA/S 12.16.5.2, 12-fold, 16 A, C load, MDRC



Fig. 10: Device illustration SA/S 12.16.5.2

9PAA0000007989-Rev_A

3.8.1 Dimension drawing

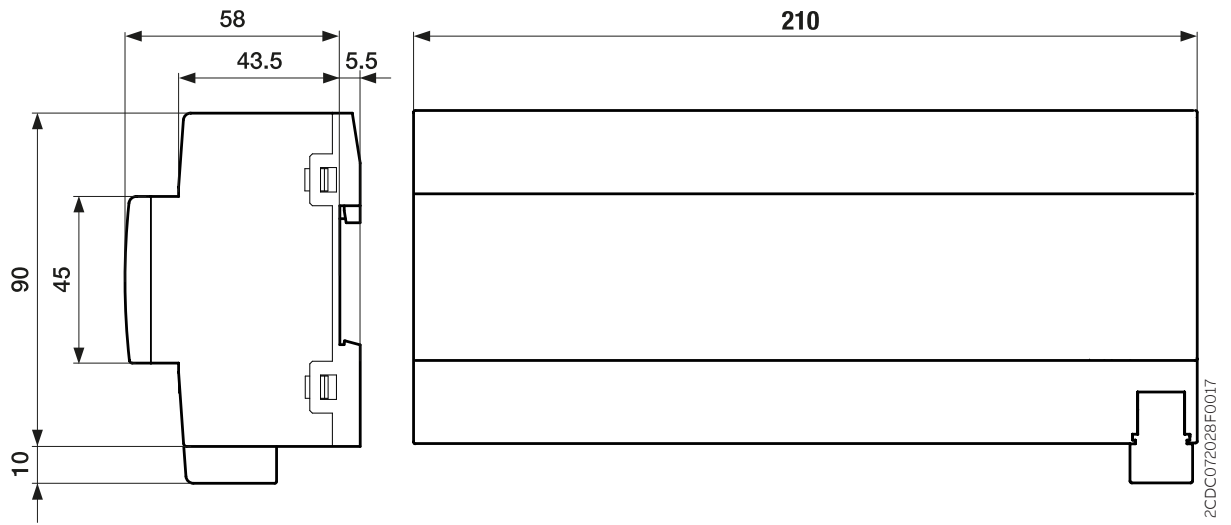

Fig. 11: Dimension drawing

3.8.2 Connection diagram

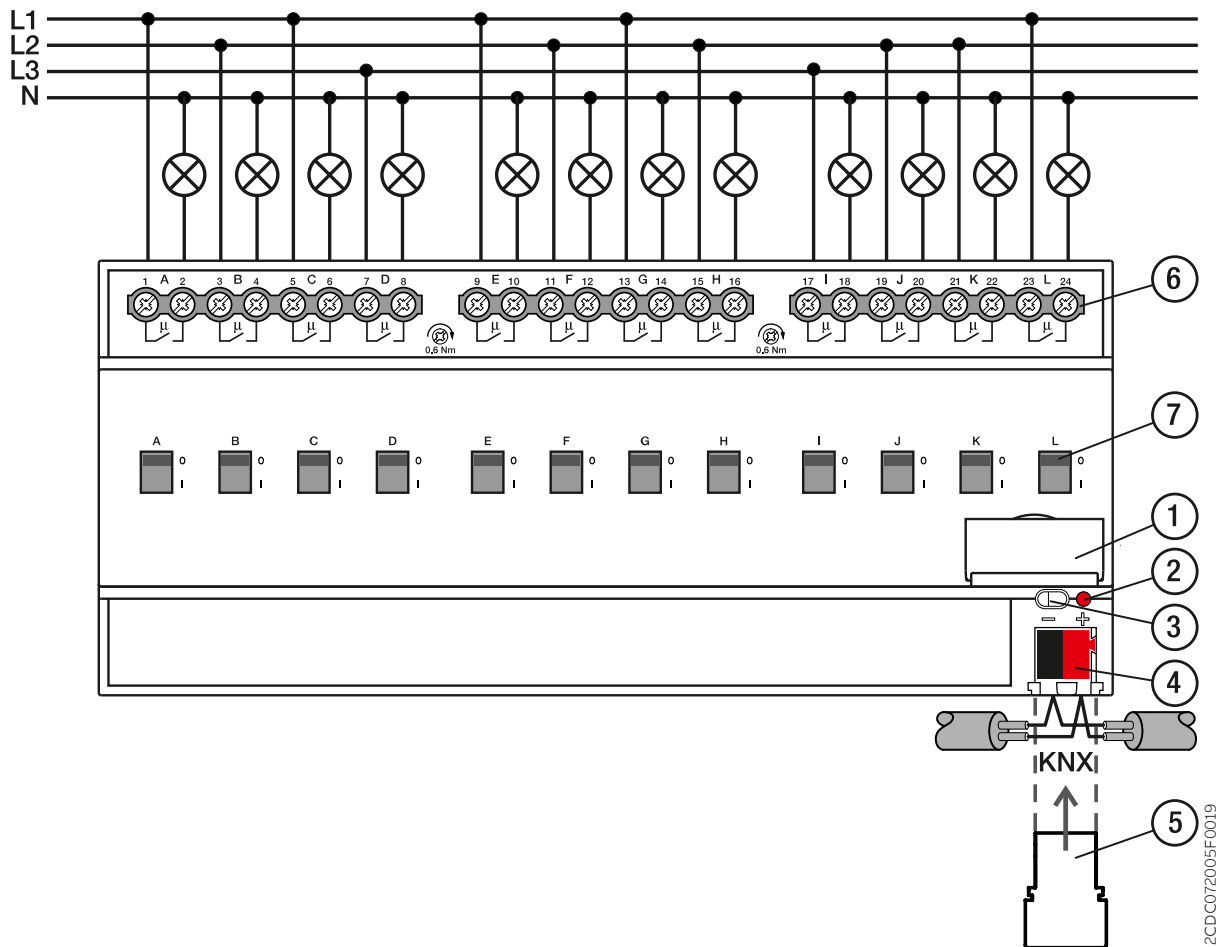



Fig. 12: Connection diagram SA/S 12.x.x.2

Legend

- 1 label carrier
- 2 *Programming* LED
- 3 *Programming* button
- 4 Bus connection terminal
- 5 Cover cap
- 6 Load circuit, two screw terminals each
- 7 Toggle switches

3.8.3 Operating and display elements

Operating control/LED	Description/function	Display
	Assignment of the physical address	LED On: Device in programming mode
<i>Programming button/LED</i>		
	Switching of the output: <ul style="list-style-type: none"> • 1 = Switch on • 0 = Switch off 	Indication of the contact position: <ul style="list-style-type: none"> • 1 = Closed • 0 = Open
Toggle switches		

Tab. 17: Operating and display elements

3.8.4 Technical data

3.8.4.1 General technical data

Device	Dimensions	90 × 210 × 63.5 mm (H x W x D)
	Mounting width in space units	12 modules, 17.5 mm each
	Weight	0.68 kg
	Mounting position	Any
	Mounting variant	35 mm mounting rail
	Design	proM
	Degree of protection	IP 54
	Protection class	II
	Overvoltage category	III
Materials	Pollution degree	2
	Housing	Polycarbonate, Makrolon FR6002, halogen free
Material note	Fire classification	Flammability V-0
Electronics	Rated voltage, bus	30 V DC
	Voltage range, bus	21 ... 31 V DC
	Current consumption, bus	< 12 mA
	Maximum current, device	12 × 20 A
	Power loss, device	≤ 12 W (16 A)/16 W (20 A)
	Power loss, bus	≤ 0.25 W
	KNX safety extra low voltage	SELV
Connections	Connection type, KNX bus	Plug-in terminal
	Cable diameter, KNX bus	0.6 ... 0.8 mm, solid
	Connection type, load circuit	Screw terminal with universal head (PZ 1)
	Pitch	7.62 mm
	Tightening torque, screw terminals	0.5 ... 0.6 Nm
	Conductor cross-section, flexible	1 × (0.2 ... 4 mm ²) / 2 × (0.2 ... 2.5 mm ²)
	Conductor cross section, rigid	1 × (0.2 ... 6 mm ²) / 2 × (0.2 ... 4 mm ²)
	Conductor cross section with wire end ferrule without plastic sleeve	1 × (0.25 ... 2.5 mm ²)
	Conductor cross section with wire end ferrule with plastic sleeve	1 × (0.25 ... 4 mm ²)
Certificates and declarations	Conductor cross section with TWIN wire end ferrule	1 × (0.5 ... 2.5 mm ²)
	Declaration of conformity CE	→ 2CDK505245D2701
Ambient conditions	Length, wire end ferrule contact pin	≥ 10 mm
	Operation	-5 ... +45 °C
	Transport	-25 ... +70 °C
	Storage	-25 ... +55 °C
	Humidity	≤ 95 %
	Condensation allowed	No
Atmospheric pressure	≥ 80 kPa (corresponds to air pressure at 2,000 m above sea level)	

Tab. 18: General technical data

3.8.4.2 Outputs – relays 16 A - 20 A (C load)







Rated values	Number of outputs	12
	Rated voltage U_n	230 V AC
	Rated current I_n (per output)	16/20 A
	Rated frequency	50/60 Hz
	Relay type	Bi-stable
Switching currents	AC-1 operation ($\cos \varphi = 0.8$)	≤ 20 A
	AC-3 operation ($\cos \varphi = 0.45$)	≤ 16 A
	Fluorescent lighting load AX	≤ 20 AX
	Switching current at 12 V AC	≥ 0.1 A
	Switching current at 24 V AC	≥ 0.1 A
Service life	Switching current at 24 V DC (resistive load)	≤ 20 A
	Mechanical service life	$\geq 10^6$ switching operations
	AC-1 operation ($\cos \varphi = 0.8$)	$\geq 10^5$ switching operations
	AC-3 operation ($\cos \varphi = 0.45$)	$\geq 3 \times 10^4$ switching operations
	AC-5a operation ($\cos \varphi = 0.45$)	$\geq 3 \times 10^4$ switching operations
Switching operations	Switching operations per minute when one relay switches	≤ 60
	Switching operations per minute when all relays switch	≤ 5
Starting current	Starting current I_{peak} (150 μ s)	≤ 600 A
	Starting current I_{peak} (250 μ s)	≤ 480 A
	Starting current I_{peak} (600 μ s)	≤ 300 A

Tab. 19: Outputs – relays 16 A – 20 A (C load)

i Note

The starting current I_{peak} is the typical ballast load current that results during switching. Using the starting current I_{peak} , it is possible to calculate the maximum number of switchable ballasts at the Switch Actuator output → [Ballast calculation, Page 149](#).

3.8.4.2.1 Load table

Load type	Symbol	Max. load
Incandescent bulbs		3680 W
Fluorescent lamps uncompensated		3680 W
Fluorescent lamps parallel compensated		2500 W
Fluorescent lamps duo circuit		3680 W
Low-voltage halogen lamps inductive transformer		2000 W
Low-voltage halogen lamps electronic transformer		2500 W
Low-voltage halogen lamps 230 V		3680 W
Dulux lamps uncompensated		3680 W
Dulux lamps parallel compensated		3000 W
Mercury-vapor lamps uncompensated		3680 W
Mercury-vapor lamps parallel compensated		3000 W
LED lamps		650 W
Rated motor power		3680 W

Tab. 23: Load table

3.8.4.3 Device type

Device type	Switch Actuator	SA/S 12.16.5.2
	Application	Switch C load 12-fold 16 A / ...
		... = current version number of the application
	Maximum number of Group Objects	286
	Maximum number of group addresses	1000
	Maximum number of assignments	1000

Tab. 20: Device type

i Note

Observe software information on the website → www.abb.com/knx.

i Note

The device may be protected with a BCU key in ETS. If a BCU key was assigned, the device cannot be read or programmed without it.

4 Function

4.1 Device functions

The devices possess mutually independent switching relays with which the following functions can be implemented:

- Switching electrical loads with high peak inrush currents in single- or multi-phase electrical networks

On-site operation of the outputs is possible using toggle switches.

4.2 Software functions

4.2.1 Functional overview

	SA/S 2.16.5.2 SA/S 4.16.5.2 SA/S 8.16.5.2 SA/S 12.16.5.2
Type of outputs	Switch Actuator
Manual operation	x
Blocking manual operation	
Function Switch	x
Staircase lighting	x
Staircase lighting advance warning	x
Delay for switching on and off	x
Flashing	x
NO contact/NC contact	x
Function Shutter	
Blind	
Shutter	
Automatic sun function	
Reversing time	
reference movement	
Function Load shedding	x
Function Energy	
Current measurement	
Power calculation	
Energy consumption	
Load monitoring	
Function Scene	x
Function Threshold	x
Function Logic	x
Forced operation/Block	x
Safety	x
Weather alarms	
Special functions	x
Contact supervision	
Reaction on bus voltage failure/recovery	x
status message	x
i-bus® Tool	x

Tab. 21: Functional overview

i Note

The interface to i-bus® Tool is available from the following software versions:

- Application from V1.2
- Firmware from V0.2.0

4.2.2 Function diagram Switch Actuator

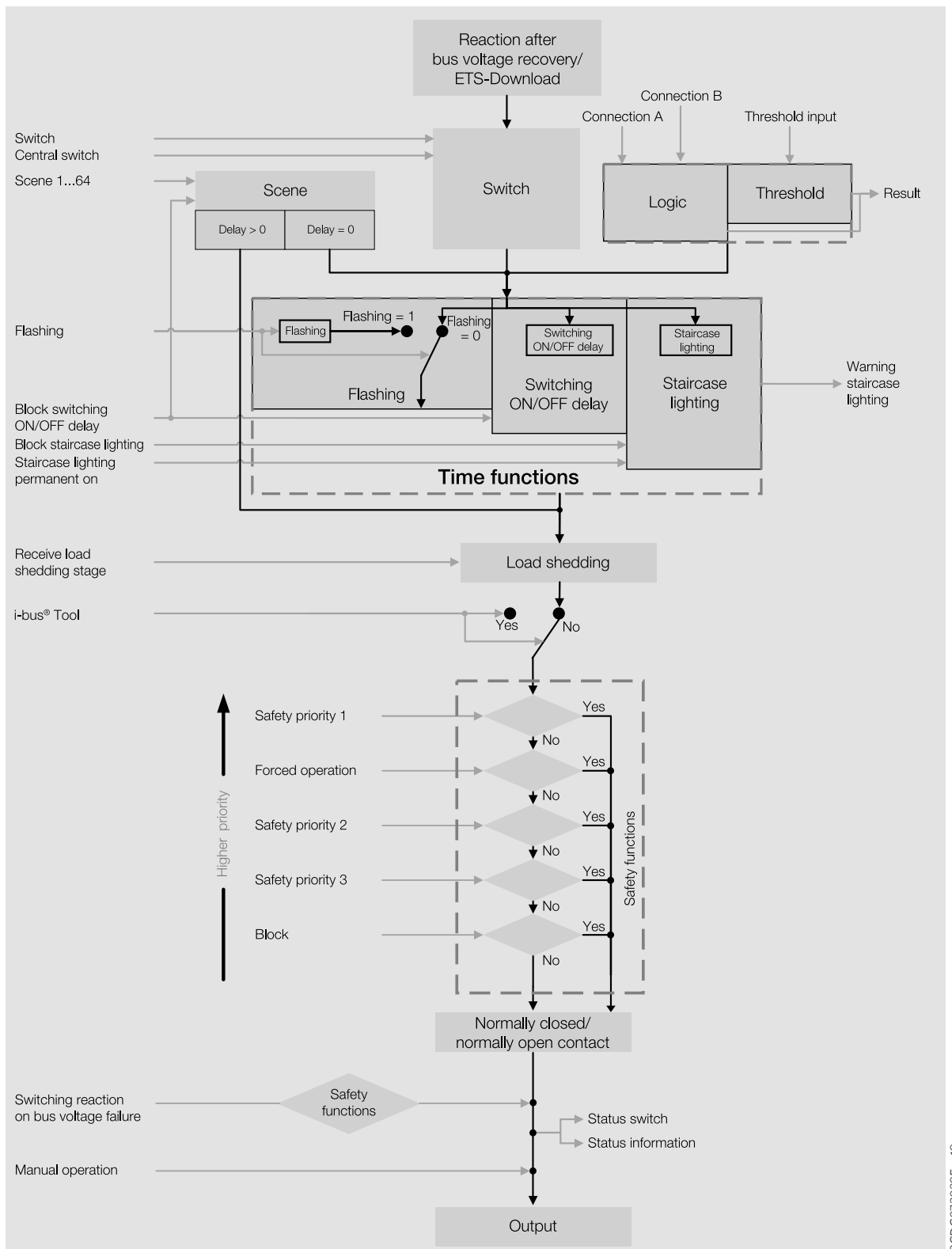

Fig. 13: Function diagram Switch Actuator

Note

The interface to i-bus® Tool is available from the following software versions:

- Application from V1.2
- Firmware from V0.2.0

4.2.3 Safety functions

4.2.3.1 Switch Actuator safety functions

4.2.3.1.1 Priority of safety functions

The safety functions *Safety priority x*, *Block* and *Forced operation* have priority over every other function. If one of these safety functions is active, operation of the corresponding output is blocked.

The order of priority of the safety functions cannot be changed, → [Priorities for Switch Actuator, Page 147](#).

4.2.3.1.2 Safety priority

This safety function is parameterized in the following parameter window:

- Parameter window [Safety](#)

The safety function *Safety priority* can be used to protect electrical loads on the switching output or to switch them in accordance with an installation situation.

Three different safety priorities are available for the Switch Actuator outputs. The user can freely select which (if any) of the safety priorities each output should react to. The position of the relay contact can be specified individually for each output for a safety priority and for the cancellation of a safety priority.

Each safety priority has its own Group Object. The Group Object and the corresponding safety function are enabled in the parameter *Enable Group Object "Safety priority x"*. Safety priority x is active if:

- A telegram with the value 1 is received on the Group Object *Safety priority x*.
- A telegram is not received on the Group Object *Safety priority x* within the time set in the parameter *Cyclical monitoring* → [Cyclical monitoring, Page 151](#).

If the safety priority is active, the relay adopts the contact position set in the parameter *Switching reaction on safety priority x* and operation is blocked.

If the corresponding safety priority is canceled, the relay adopts the contact position set in the parameter *Switching reaction on cancellation of block, forced operation and safety priority* and operation is enabled.

Note

If a safety priority is active, the operation of the output via Group Objects and i-bus® Tool is blocked. Higher-priority safety functions continue to run → [Function diagram Switch Actuator, Page 40](#).

4.2.3.1.3 Block

Block

This safety function is parameterized in the following parameter window:

- Parameter window [Safety](#)

The safety function *Block* can be used to block the output via the Group Object *Block* [Switch Actuator]. The relay adopts the contact position specified in the parameter *Switching reaction on block* and operation is blocked.

If the block is canceled, the relay adopts the contact position set in the parameter *Switching reaction on cancellation of block, forced operation and safety priority* and operation is enabled.

Note

If the safety function is active, the operation of the output via Group Objects and i-bus® Tool is blocked.

Higher-priority safety functions continue to run → [Function diagram Switch Actuator, Page 40](#).

4.2.3.1.4**forced operation**

This safety function is parameterized in the following parameter window:

- Parameter window [Safety](#)

The safety function *Forced operation* can be used to set the device outputs to a defined state and block them.

A state that is set if forced operation is activated can be parameterized with 1-bit forced operation. It can additionally be defined whether activation is to take place via the value 1 or 0.

With 2-bit forced operation, two states are specified that are set if forced operation is activated. Forced operation is activated/deactivated with the first bit. The defined state is set with the second bit.

Bit 1	Bit 0	State of forced operation
0	0	Forced operation inactive
0	1	Forced operation inactive
1	0	Forced operation active, state Off
1	1	Forced operation active, state On

Tab. 22: Coding of 2-bit forced operation

The safety function *Forced operation* is activated in the parameter [Forced operation \(1 bit / 2 bit\) \[Switch Actuator\]](#).

The position of the relay contact during forced operation is specified in the parameter [Switching reaction on forced operation](#).

The position of the relay contact if forced operation is canceled is specified in the parameter [Switching reaction on cancellation of block, forced operation and safety priority](#).

Example

The safety function *Forced operation* can be used to ensure that all lights are switched on and secured against switching off during a fire alarm.

Note

If the safety function is active, the operation of the output via Group Objects and i-bus® Tool is blocked.

Higher-priority safety functions continue to run → [Function diagram Switch Actuator, Page 40](#).

4.2.4**Function Logic**

This function is parameterized in the following parameter window:

- Parameter window [Logic/Threshold](#) \ Parameter window [Logic/Threshold x](#)

The functions *Logic* and *Threshold* can be used independent of other functions.

The function *Logic* can be used to influence the reaction of an output by means of the following logic functions:

- AND
- OR
- Exclusive OR
- GATE
- 1 bit Inverter

Two input Group Objects (*Connection A*, *Connection B*) and one result Group Object (*Status Result [Logic]*) are available for the AND, OR, exclusive OR and GATE logic functions.

An input Group Object (*Connection A*) and a result Group Object (*Status Result [Logic]*) are available for the 1-bit inverter.

The result can be linked internally to any output in the parameter *Output reacts to* or output on the Group Object *Status Result [Logic]*.

If the result is linked internally to an output, the result has the same priority as Scene recalls or switching commands → [Function diagram Switch Actuator, Page 40](#).

The send behavior of the Group Object *Status Result [Logic]* is defined in the parameter *Send value of Group Object "Status Result"*. Internally in the device, the result is updated when a value is received on one of the two input Group Objects.

The result is dependent on the logic function selected and the values in the corresponding input Group Objects. Refer to the table below for information about the reaction of the logic functions:

Logic function	Connection A	Connection B	Result	Explanation
AND	0	0	0	The result is 1 if both input values are 1.
	0	1	0	
	1	0	0	
	1	1	1	
OR	0	0	0	The result is 1 if at least one of the input values is 1.
	0	1	1	
	1	0	1	
	1	1	1	
Exclusive OR	0	0	0	The result is 1 if the input values differ.
	0	1	1	
	1	0	1	
	1	1	0	
GATE	Blocked	0	-	The input value (Connection B) is processed only if the GATE is open. The value is ignored if the GATE is blocked.
	Open	0	0	
	Blocked	1	-	
	Open	1	1	
1 bit Inverter	0	-	1	The input value (Connection A) is inverted.
	1	-	0	

Tab. 23: Results of the logic functions

The result is recalculated when a value is received on one of the two input Group Objects *Connection A* or *Connection B*.

4.2.5 Function Threshold

This function is parameterized in the following parameter window:

- Parameter window *Logic/Threshold* \ Parameter window *Logic/Threshold x*

The functions *Logic* and *Threshold* can be used independent of other functions.

The function *Threshold* is used to compare the value received on the threshold input with the thresholds set in the parameters *Upper threshold* and *Lower threshold*.

A minimum duration for undershooting and overshooting the thresholds can be defined in the following parameters:

- *Min. duration of the overshoot*
- *Min. duration of the undershoot*
- *Minimum dwell time between the thresholds*

One of the following Group Objects is used as the threshold input, depending on the setting in the parameter *Data point type of Group Object "Threshold input"*:

- *Threshold input* (DPT 13.010)
- *Threshold input* (DPT 13.013)
- *Threshold input* (DPT 14.019)
- *Threshold input* (DPT 14.056)
- *Threshold input* (DPT 5.001)
- *Threshold input* (DPT 5.010)
- *Threshold input* (DPT 7.001)
- *Threshold input* (DPT 9.001)
- *Threshold input* (DPT 9.004)
- *Threshold input* (DPT 9.021)
- *Threshold input* (DPT 9.024)

A result can be defined in the following parameters depending on whether the value on the threshold input is above or below the thresholds:

- *Result if upper threshold is exceeded*
- *Result if lower threshold is dropped below*

The result can be linked internally to any output in the parameter *Output reacts to* or output on the Group Object *Status Result [Threshold]*.

If the result is linked internally to an output, the result has the same priority as Scene recalls or switching commands → [Function diagram Switch Actuator, Page 40](#).

The parameter *Monitor range between thresholds* can be used to define whether the range between the upper and lower thresholds is monitored and an evaluation is output on the Group Object *Status Input value between thresholds*.

The send behavior of the Group Objects *Status Result [Threshold]* and *Status Input value between thresholds* is defined in the parameter *Send values of Group Objects "Status Result" and "Status Input value between thresholds"*. Internally in the device, the result is updated when a value is received on the threshold input.

The thresholds set in ETS can be changed via the bus (ABB i-bus® KNX). The setting is made in the following parameters:

- *Change thresholds via Group Objects*
- *Change thresholds via i-bus® Tool*

The modified thresholds are received on the following Group Objects via the bus (ABB i-bus® KNX), depending on the setting in the parameter *Data point type of Group Object "Threshold input"*:

- *Change upper threshold* (DPT 13.010)
Change lower threshold (DPT 13.010)
- *Change upper threshold* (DPT 13.013)
Change lower threshold (DPT 13.013)
- *Change upper threshold* (DPT 14.019)
Change lower threshold (DPT 14.019)
- *Change upper threshold* (DPT 14.056)
Change upper threshold (DPT 14.056)
- *Change upper threshold* (DPT 5.001)
Change lower threshold (DPT 5.001)
- *Change upper threshold* (DPT 5.010)
Change lower threshold (DPT 5.010)
- *Change upper threshold* (DPT 7.001)
Change lower threshold (DPT 7.001)
- *Change upper threshold* (DPT 9.001)
Change lower threshold (DPT 9.001)
- *Change upper threshold* (DPT 9.004)
Change lower threshold (DPT 9.004)
- *Change upper threshold* (DPT 9.021)
Change lower threshold (DPT 9.021)
- *Change upper threshold* (DPT 9.024)
Change lower threshold (DPT 9.024)

In the parameter *Overwrite thresholds on download* it is defined whether the thresholds changed via the bus (ABB i-bus® KNX) are overwritten with the thresholds set in ETS during an application download.

4.2.6 Function Load shedding

This function is parameterized in the following parameter window:

- Parameter window *Switch Actuator X* \ Parameter window *Load shedding*

With the function *Load shedding*, a load control master (e.g. Energy Analyzer QA/S, Energy Actuator SE/S) can manage an electrical installation energy efficiently. If a defined load limit is exceeded, the load control master sends switching commands in the form of load shedding stages on the bus (ABB i-bus® KNX). The slave devices receive the load shedding stages and react as per the parameterization.

The load shedding stages can be defined individually for each channel in the slave devices.

The functionality is explained in the following example based on a QA/S as the master:

Note

The QA/S (master) processes eight load shedding stages in this example. The number of load shedding stages must be matched between master and slave.

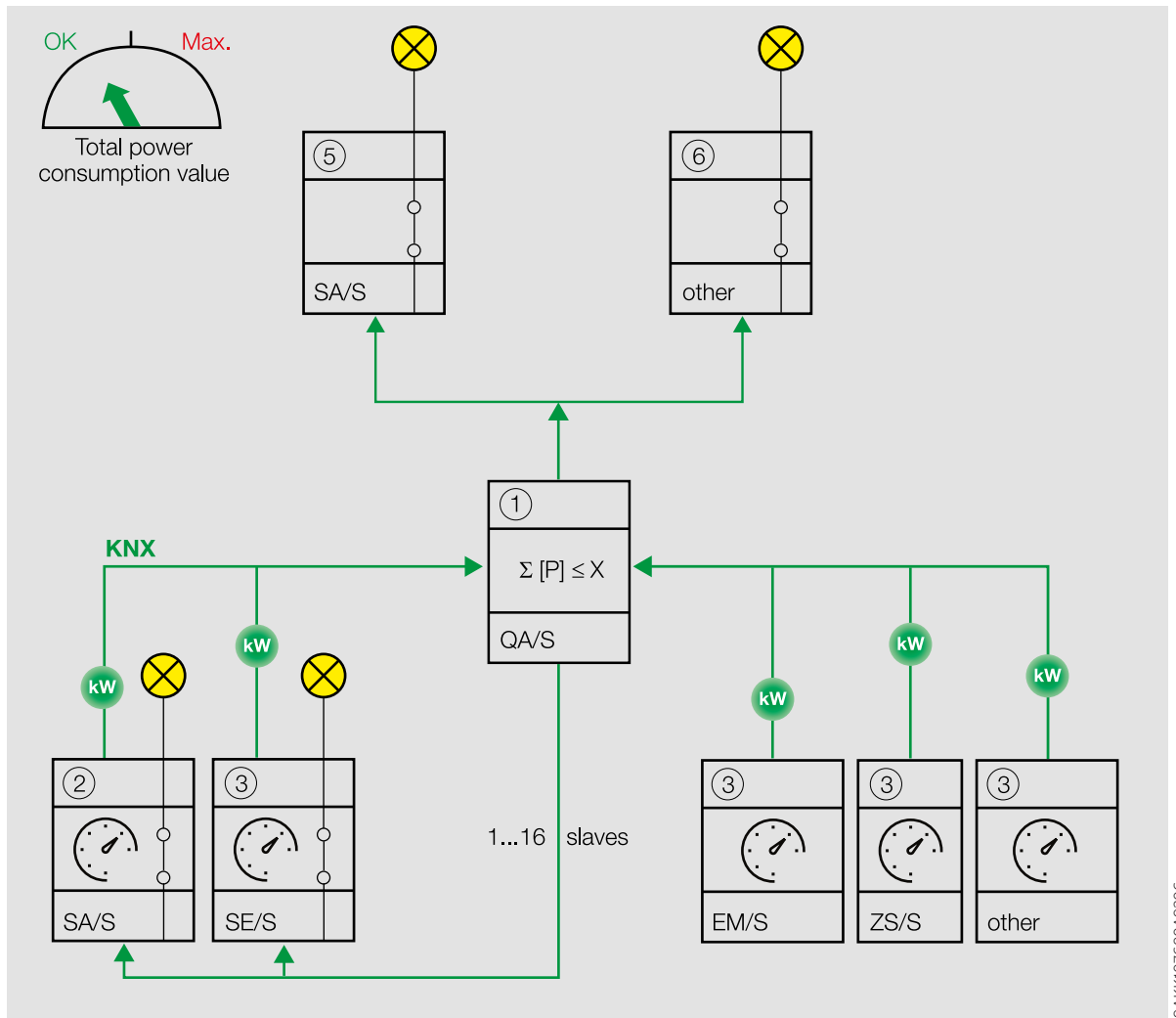

Fig. 14: Master receives power values

The QA/S (master) (1) receives power values from up to 16 slaves (e.g. SA/S x.16.6.2 (2) or energy meters such as SE/S, EM/S, ZS/S (3)). Devices (5) (6) that do not send any direct energy consumption values can also be integrated into the function *Load shedding* via an energy meter (e.g. ZS/S (3)).

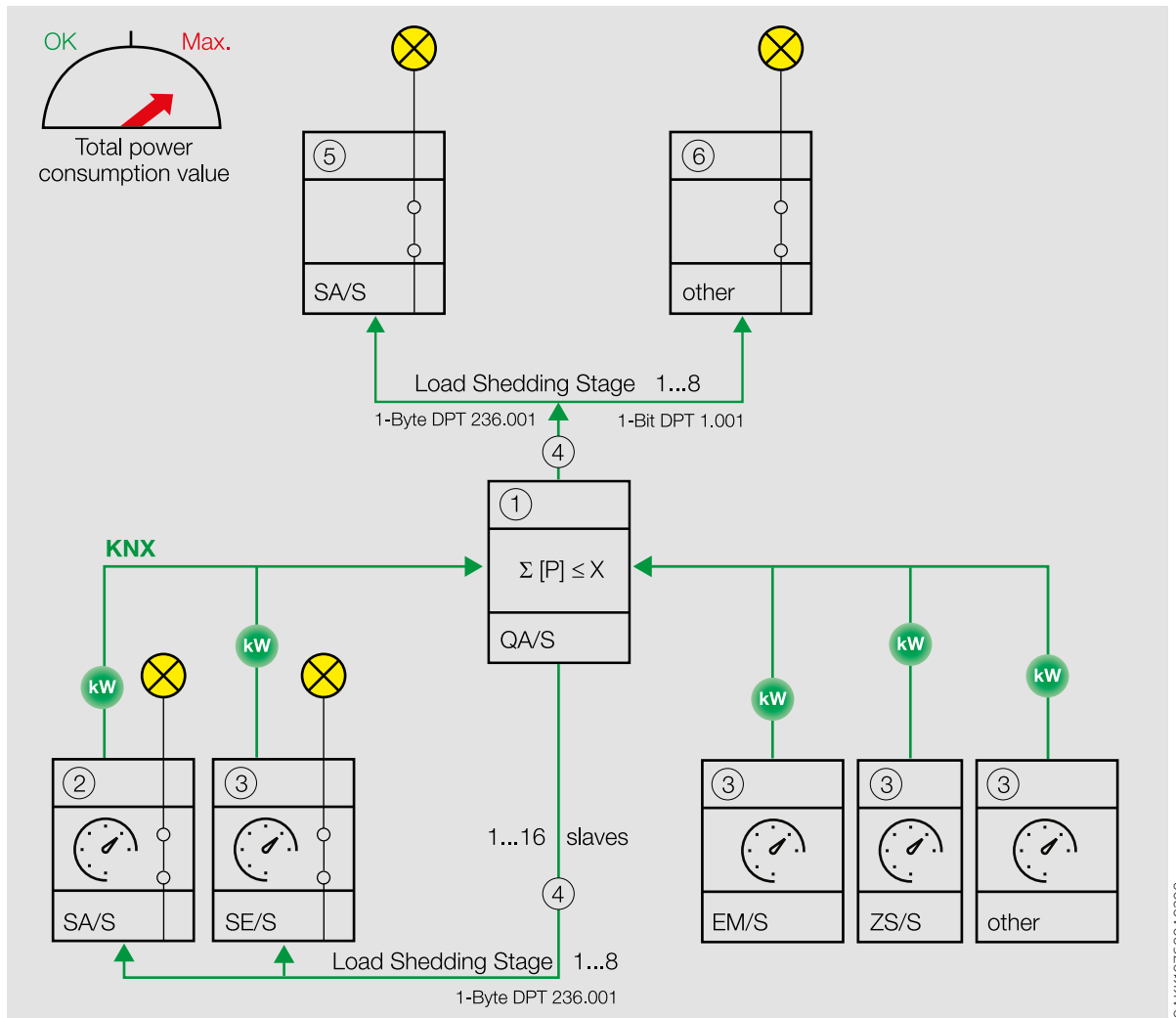

Fig. 15: Master adds together power values received

The master adds together the power values received and calculates the total power consumption. If the total power consumption exceeds the load limit defined, the master sends load shedding stages (4) on the bus (ABB i-bus® KNX).

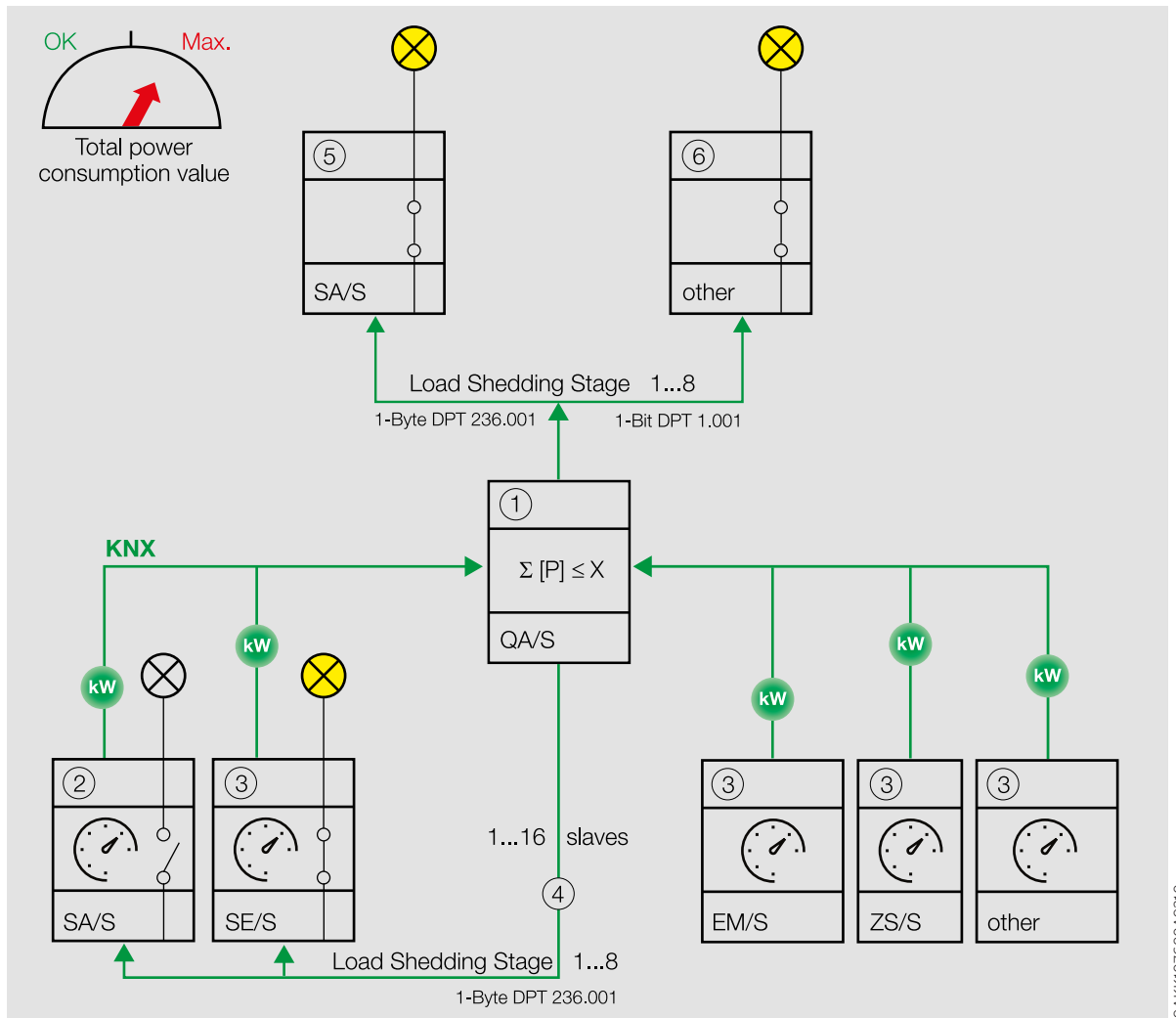

Fig. 16: Slaves receive load shedding stages

The slaves receive the load shedding stages and switch all channels that are assigned to this load shedding stage, corresponding to the reaction defined in the parameter *Switching reaction on active load shedding stage*.

Note

Integration of other devices into the load shedding → corresponding product manuals.

Note

- All ABB Switch Actuators (5) (Combi, Standard and Professional) contain the function *Load shedding*, including the Group Object *Receive load shedding stage* (DPT 236.001).
- Other devices (6) without the Group Object *Receive load shedding stage* (DPT 236.001) can be integrated into the function *Load shedding* using the Group Objects "Send load shedding stage x" (DPT 1.001) of the QA/S Energy Analyzer.

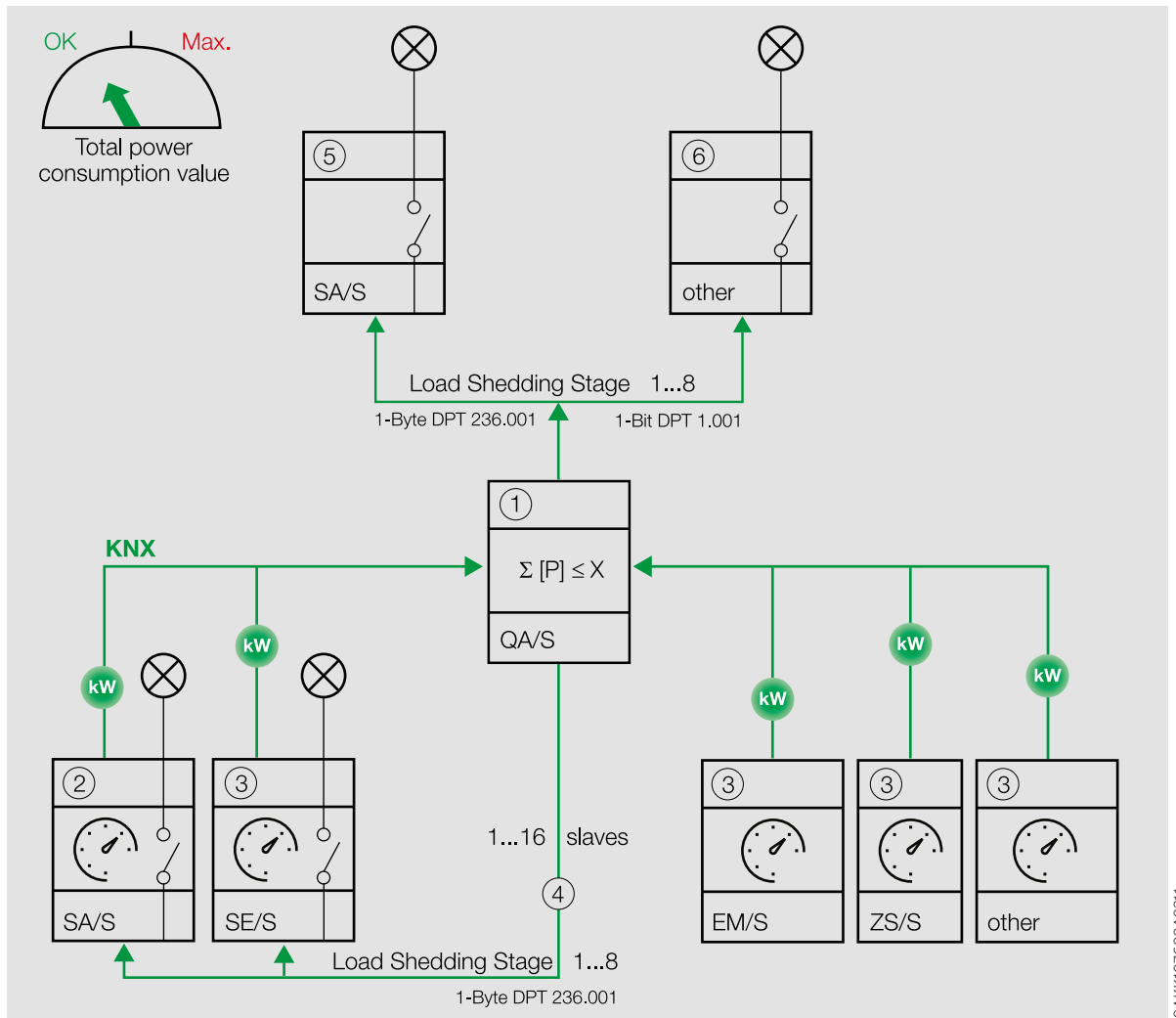

Fig. 17: Master increases load shedding stage

The master increases the load shedding stage until the total power consumption drops below the load limit.

Note

Integration of other devices into the load shedding → corresponding product manuals.

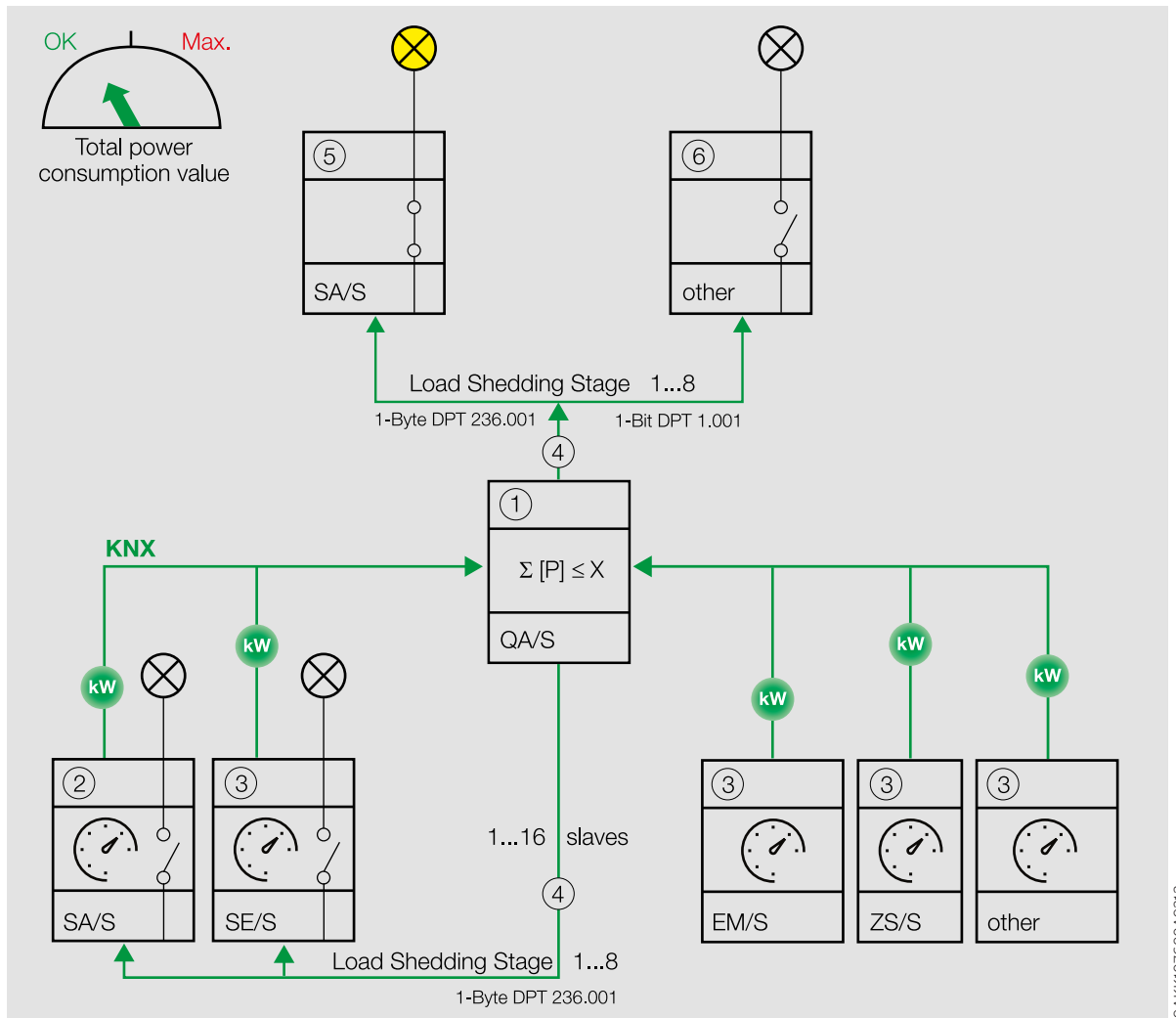

Fig. 18: Master decreases load shedding stage

Once the total power consumption has dropped below the load limit, the master (1) decreases the load shedding stage and sends this information via the bus (ABB i-bus® KNX) to the slaves. The channels react corresponding to the setting in the parameter *Switching reaction on revoke of load shedding stage*.

The load shedding stage for the channel is defined in the parameter *Load shedding stage*.

The load shedding stage set in ETS can be changed via the bus (ABB i-bus® KNX). The setting is made in the following parameters:

- *Change load shedding stage via Group Object*
- *Change load shedding stage via i-bus® Tool*

The modified load shedding stage is received on the Group Object *Set load shedding stage* via the bus (ABB i-bus® KNX).

In the parameter *Overwrite load shedding stage at download* it is defined whether the load shedding stage changed via the bus (ABB i-bus® KNX) is overwritten with the load shedding stage set in ETS during an application download.

4.2.7 Function Scenes

This function is parameterized in the following parameter window:

- Parameter window *Switch Actuator X* \ Parameter window *Scene assignments [Switch Actuator]*

The function *Scenes* can be used to create, to enable, to assign Scenes to the output and to incorporate additional KNX devices in a Scene. It is a prerequisite that all the devices incorporated are parameterized with the same Scene number and recall is via the same group address.

The following parameters can be used to create, enable and assign to the output up to 16 Scenes:

- [Enable Scene assignment x \[Switch Actuator\]](#)

An individual number (1 ... 64) is assigned for each Scene in the parameter [Scene number](#).

The reaction of the output during Scene recall is defined in the parameter [Reaction on Scene recall](#).

The parameter [Delay](#) is used to define the delay with which the Scene is run after Scene recall.

Note

If a delay is used for Scene recall (→ parameter [Delay](#)), the output does not react to the functions [Staircase lighting](#) and [Delay for switching on and off](#) → [Function diagram Switch Actuator, Page 40](#).

Scene recall

A Scene is recalled via the following Group Objects:

- [Scene 1 ... 64](#)
A Scene number is received via this central Group Object. All outputs and KNX devices incorporated execute the Scenes assigned with the corresponding Scene number. Depending on the telegram value, the current positions of the relay contacts for all outputs and KNX devices integrated can be saved in the Scene. In this way, the contact position for a Scene number can be overwritten.
- [Scene 1...64](#)
A Scene number is received via this Group Object. The output executes all Scenes assigned with the corresponding Scene number. Depending on the telegram value, the current position of the relay contact can be saved in the Scene. In this way, the contact position for a Scene number can be overwritten.
- [Recall Scene assignment x](#)
The Scene assignment x (x = 1 ... 4) for the output is recalled via these 1-bit Group Objects and the corresponding Scene number executed. This direct Scene recall is possible only for Scene assignments 1 ... 4.

4.2.7.1 Structure of 1-byte Scene telegram

A 1-byte Scene telegram contains the Scene number (1 ... 64) and information about whether to recall or save the Scene.

Telegram value:

- 0 ... 63 = Recall Scene x (x = 1 ... 64)
- 128 ... 191 = Save Scene x (x = 1 ... 64)

More information: → [Table of values, Group Object "Scene 1 ... 64", Page 155](#).

4.2.8 Time functions

Three time functions are available for each output. The parameter [Enable function Time](#) can be used to assign one of the following time functions to each output:

- → [Function Staircase lighting, Page 52](#)
- → [Function Delay for switching on and off, Page 54](#)
- → [Function Flashing, Page 55](#)

The selected time function is integrated into the function chain for the output.

More information: → [Function diagram Switch Actuator, Page 40](#).

4.2.8.1 Function Staircase lighting

This function is parameterized in the following parameter window:

- [Staircase lighting](#)

The function *Staircase lighting* can be used for time-controlled lighting (e.g. staircase lighting) or to control automatically an application with a similar function.

i Note

If a delay is used for Scene recall (→ parameter *Delay*), the output does not react to the functions *Staircase lighting* and *Delay for switching on and off* → [Function diagram Switch Actuator, Page 40](#).

The switch-on duration is defined in the parameter *Staircase lighting time*.

Depending on the option selected in the parameter *Switching reaction of staircase lighting on telegram value 0/1*, the receipt of a telegram with the value 0 or 1 on one of the following Group Objects produces switching:

- [Switch](#)
- [Switch \(Central\)](#)
- [Scene 1...64](#)
- [Scene 1 ... 64 \(Central\)](#)
- [Status Result \[Logic\]](#)
- [Status Result \[Threshold\]](#)

If the contact is defined as normally opened in the parameter *Reaction of output*, the contact is closed on receipt of a switch-on value and opened after the staircase lighting time has elapsed.

If the contact is defined as normally closed in the parameter *Reaction of output*, the contact is opened on receipt of a switch-on value and closed after the staircase lighting time has elapsed.

The function *Staircase lighting* can notify of the imminent switching off (→ parameter *Warning time*). The warning time starts after the staircase lighting time has elapsed. The type of warning is defined in the parameter *Warning before switching off the staircase lighting*:

- Via the Group Object [Warning staircase lighting](#):
The Group Object is set to the value 1 at the start of the warning time. The Group Object is set to the value 0 when the warning time elapses. The Group Object can be used to switch a warning light.
- Via short switching off/on:
The output is briefly switched off and then back on during the warning time. The number of Off/On changes can be defined in the parameter [Number of Off/On changes](#). The first Off/On change takes place at the beginning of the warning time. Additional Off/On changes are uniformly distributed over the remaining warning time.

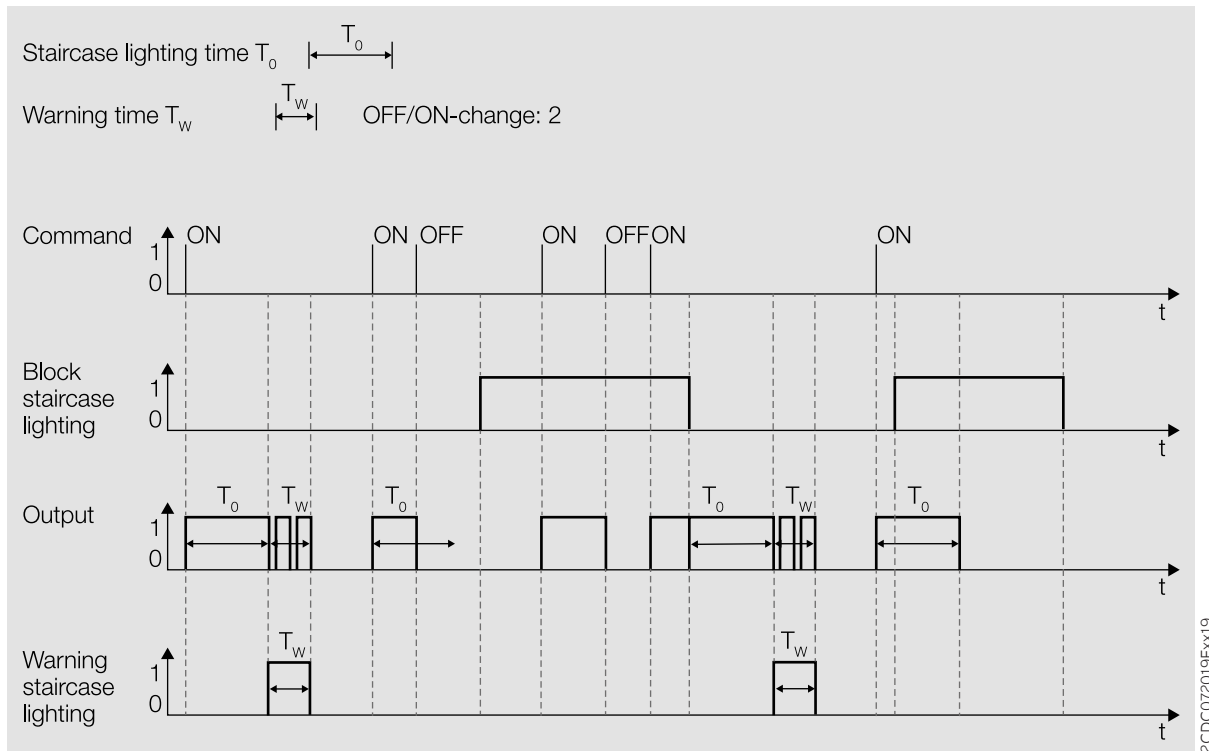

Fig. 19: Switch-on/switch-off reaction of the function Staircase lighting

4.2.8.1.1

Extending staircase lighting time (retriggering/pumping)

The staircase lighting time can be restarted if the option *Yes* is selected in the parameter *Staircase lighting time can be started again*.

Retriggering

The staircase lighting time can be restarted any number of times if the option *No, can only be started again* is selected in the parameter *Staircase lighting time extendable (pumping)*.

Pumping

If the option “Up to max. x times staircase lighting time” ($x = 2 \dots 5$) is selected in the parameter *Staircase lighting time extendable (pumping)*, the staircase lighting time can be extended to max. five times the duration. If further switch-on commands are received during the staircase lighting time or during the warning time, the staircase lighting time is extended by a further staircase lighting time.

The following diagram shows the reaction on extension to quintuple the staircase lighting time:

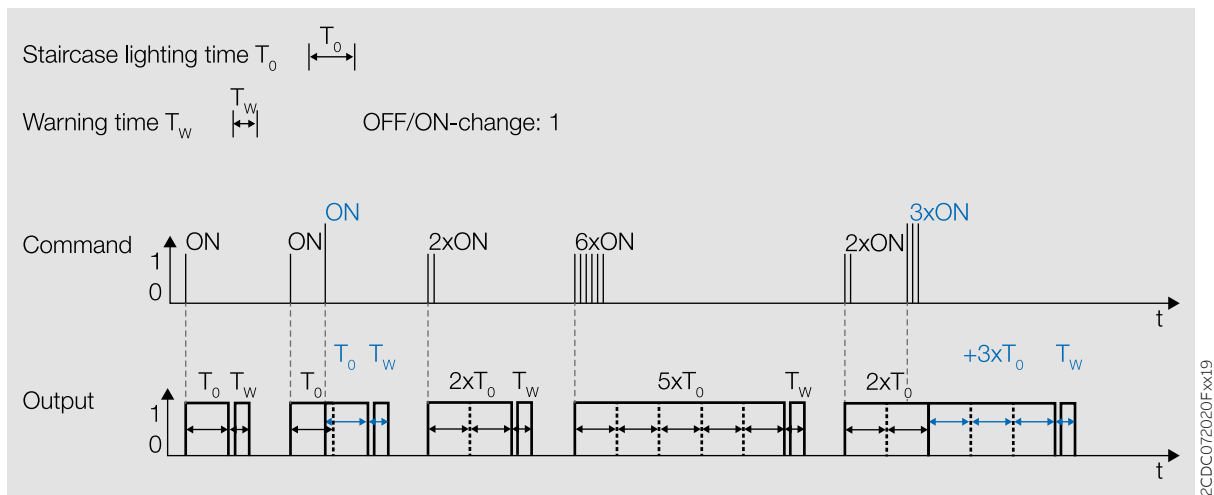

Fig. 20: Extending staircase lighting time (retriggering/pumping)

4.2.8.1.2

Block staircase lighting

The function *Staircase lighting* can be blocked via the Group Object *Block staircase lighting*. If the function *Staircase lighting* is blocked, the switch-on command is forwarded without time function in the function chain (→ [Function diagram Switch Actuator, Page 40](#)) and the output reacts according to its parameterization.

4.2.8.1.3

Permanent on

If the function *Staircase lighting* is activated, the output can be permanently switched on via the Group Object *Staircase lighting permanent on*. If Permanent on operation is activated, the output remains switched on. Other functions continue to run in the background, but they do not trigger any switching operation. If Permanent on operation is deactivated, the output reacts to the Group Object *Switch*.

The parameter *Restart staircase lighting time after permanent on* can be used to define how the lighting reacts after the end of Permanent ON operation.

After a download or bus voltage recovery, the Permanent on operation state from before the download or bus voltage failure is restored.

4.2.8.2

Function Delay for switching on and off

This function is parameterized in the following parameter window:

- *Delay for switching on and off*

Using the function *Delay for switching on and off*, the effect of a switching command received on one of the following Group Objects can be delayed:

- *Switch*
- *Switch (Central)*
- *Scene 1...64*
- *Scene 1 ... 64 (Central)*
- *Status Result [Logic]*
- *Status Result [Threshold]*

i Note

If a delay is used for Scene recall (→ parameter *Delay*), the output does not react to the functions *Staircase lighting* and *Delay for switching on and off* → [Function diagram Switch Actuator, Page 40](#).

The duration of the delay is set in the following parameters:

- [Delay for switching on](#)
- [Delay for switching off](#)

Reaction of the delay for switching on:

- The delay for switching on starts after the reception of a switch-on command (telegram with the telegram value 1).
- If a switch-on command is received during the delay for switching on, the time for the delay for switching on restarts.
- If a switch-off command is received during the delay for switching on, the switch-on is discarded.

Reaction of the delay for switching off:

- The delay for switching off starts after the reception of a switch-off command (telegram with the telegram value 0).
- If a switch-off command is received during the delay for switching off, the time for the delay for switching off restarts.
- If a switch-on command is received during the delay for switching off, the switch-off is discarded.

i Note

Whether the relay contact is opened or closed depends on the setting in the parameter [Reaction of output](#).

4.2.8.3

Function Flashing

This function is parameterized in the following parameter window:

- [Flashing](#)

The function *Flashing* can be used to switch the relay contact alternately after receipt of a switch-on command.

The switch-on command is issued via the Group Object [Flashing](#). Each switch-on command restarts the flashing cycle.

The parameter [Flashing if Group Object "Flashing" is](#) can be used to define the telegram value with which a flashing cycle can be started and prematurely ended.

The number and duration of the flashing cycles can be defined in the following parameters:

- [Time for on](#)
- [Time for off](#)
- [Number of flashing cycles](#)

Each flashing cycle begins with the On state. Whether the relay contact is opened or closed depends on whether the output is defined as a normally closed contact or normally opened contact in the parameter [Reaction of output](#).

Each flashing cycle begins with the Off state. The position of the relay contact after the end of the flashing cycle can be specified in the parameter [Reaction after flashing](#).

If the function *Flashing* is active, the output does not react to other switching commands → [Function diagram Switch Actuator, Page 40](#).

i Note

If the function *Flashing* is used:

- Pay attention to the service life of the lighting equipment.
- Take into account the service life of the switching contacts → Technical data.

Note

Each relay can perform only a limited number of switching operations per minute → Technical data. A large number of switching operations per minute can delay switching.

4.3 Integration into i-bus® Tool

i-bus® Tool can be used to read the data from connected devices. It can also be used to simulate values and test the following functions:

- Function of the physical inputs and outputs

If there is no communication between the devices and i-bus® Tool, the simulated values cannot be sent on the bus.

For more information → parameter *i-bus® Tool access*.

i-bus® Tool can be downloaded free of charge from the company homepage (www.abb.com/knx).

Note

The interface to i-bus® Tool is available from the following software versions:

- Application from V1.2
- Firmware from V0.2.0

4.4 Special operating states

The devices' reaction on bus voltage failure, after bus voltage recovery and after ETS download can be set in the device parameters.

4.4.1 Reaction on bus voltage failure

Bus voltage failure describes the failure of the bus voltage, e.g. due to a power failure.

The reaction of the Switch Actuator outputs can be defined in the parameter window *Basic settings [Switch Actuator]*, in the parameter *Switching reaction on bus voltage failure*.

4.4.2 Reaction after bus voltage recovery

Bus voltage recovery is the state that exists after the bus voltage is restored. The devices will restart after bus voltage recovery.

The time set in the parameter *Sending and switching delay after bus voltage recovery* is awaited before the devices perform an action.

The reaction of the Switch Actuator outputs can be defined in the parameter window *Basic settings [Switch Actuator]*, in the parameter *Reaction after bus voltage recovery [Switch Actuator]*.

4.4.3 Reaction on ETS reset

An ETS reset restarts the ETS application in the devices. ETS reset can be performed in ETS using the Commissioning menu item, in the function *Reset device* (from ETS version 6 *Restart device*).

During an ETS reset, the device reacts the same way as during bus voltage failure.

The reaction of the Switch Actuator outputs can be defined in the parameter window *Basic settings [Switch Actuator]*, in the parameter *Switching reaction on bus voltage failure*.

4.4.4 Reaction during download

Downloading describes loading a modified or updated ETS application onto the devices. The devices are not ready to operate during a download.

Reaction of the Switch Actuator outputs:

The positions of the relay contacts are blocked at the start of the download. The reaction after download can be defined in the parameter window *Basic settings [Switch Actuator]*, in the parameter *Reaction after ETS download [Switch Actuator]*.

Note

The device will no longer operate after the application is uninstalled or the download is canceled.

- ▶ Download again.

5 Mounting and installation

5.1 Information about mounting



DANGER – Severe injuries due to touch voltage

Electric feedback from different phase conductors can cause contact voltages and lead to serious injuries.

- ▶ Operate the device only in a closed housing (distribution board).
- ▶ Disconnect all phases before working on the electrical connection.

The device can be mounted in any position as required on a 35 mm mounting rail.

The electrical connection to the loads is made using screw terminals. The connection to the bus (ABB i-bus® KNX) is made using the bus connection terminal supplied. The terminal designation is located on the housing.

Note

The maximum permissible current consumption on a KNX line must not be exceeded.

- ▶ During planning and installation, ensure that the KNX line is correctly dimensioned. The device has a maximum current consumption of 12 mA.

5.2 Mounting on mounting rail

Note

No additional tools are required for mounting on a mounting rail.

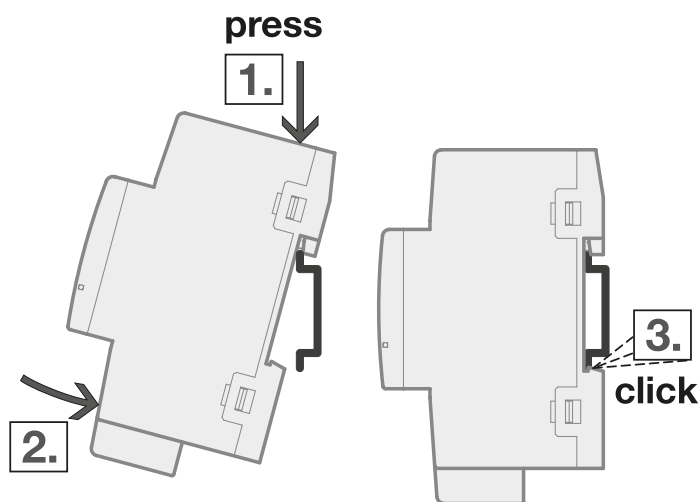

Fig. 21: Mounting on mounting rail

1. Place the mounting rail holder on the upper edge of the mounting rail and push down.
2. Push the lower part of the device toward the mounting rail until the mounting rail holder engages.
 - ⇒ The device is now mounted on the mounting rail.
3. Relieve the pressure on the top of the housing.

6 Commissioning

6.1 Prerequisites for commissioning

A PC with ETS and a connection to the bus (ABB i-bus® KNX), e.g. via a KNX interface, are required to commission the device.

- Required ETS version: 5.6 or higher
- Product-specific application: installed

6.2 Commissioning overview

After the bus voltage is activated for the first time, the following factory settings will be selected automatically:

- Physical address of the device: 15.15.255
- ETS application: preloaded
- Switching contact position: open

The device can be programmed only using ETS.

i Note

The complete ETS application can be downloaded again if required. Downloads may take longer after an application is uninstalled or when changing applications.

6.3 Putting device into operation

1. Connect the device to the bus (ABB i-bus® KNX).
2. Switch on bus voltage.
 - ⇒ All switching contacts are open.
3. Switch on power supply of the connected loads.
 - ⇒ Device is ready for operation.

6.4 Assignment of the physical address

i Note

If it is set in ETS that the application is to be downloaded during programming, the download will begin after assignment of the physical address.

Triggering assignment of the physical address via ETS:

1. Press *Programming* button.
 - ⇒ Programming mode active. *Programming* LED lights up.
2. Start programming process in ETS.
 - ⇒ Physical address is assigned. Device restarts.

i Note

The device performs an ETS reset during assignment of the physical address. All states are reset.

6.5 Software/application

6.5.1 Download reaction

Depending on the PC, it can take up to 90 seconds for the progress bar to appear during a download.

Using an interface that supports download via "long frames" (e.g. USB/S 1.2 or IPR/S 3.5.1) can greatly shorten the download time.

6.5.2 Copying, exchanging and converting

The following functions can be performed with the ETS app *ABBUpdate Copy Convert*:

- *Update*: Changes the application program to a higher or lower version while retaining the current configurations
- *Convert*: Transfers/adopts a configuration from an identical or compatible source device
- *Copy channel*: Copies a channel configuration to other channels on a multichannel device
- *Channel exchange*: Exchanges configurations between two channels on a multichannel device
- *Import/export*: Saves and reads device configurations as external files

The ETS app *ABBUpdate Copy Convert* can be downloaded free of charge from the KNX Shop → www.KNX.org.

7 Parameters

7.1 General

Note

ETS (Engineering Tool Software) is used to parameterize the device.

The following sections describe the device parameters based on the parameter windows. The parameter windows have a dynamic design. Parameters are shown or hidden depending on parameterization and function.

The default values of the parameters are underlined, e.g.:

No (checkbox cleared)

Yes (checkbox ticked)

Note

The default values in the ETS application can vary from the values stated in the product manual depending on the product variant.

Note

A device with 12 channels (A ... L) is described below.

7.2 Parameter windows

7.2.1 Parameter windows Configuration

The following settings can be made in this parameter window:

- Enable outputs
- Enable functions *Logic* and *Threshold*
- Limit number of telegrams sent
- Activate i-bus® Tool access

Note

The interface to i-bus® Tool is available from the following software versions:

- Application from V1.2
- Firmware from V0.2.0

The screenshot shows a configuration window with a left sidebar and a main content area. The sidebar lists various settings with expandable options. The main content area contains a note about firmware requirements and several configuration sections.

Section	Item	Status	
Enable outputs:	Output A	<input checked="" type="checkbox"/>	
	Output B	<input checked="" type="checkbox"/>	
	Output C	<input checked="" type="checkbox"/>	
	Output D	<input checked="" type="checkbox"/>	
	Output E	<input checked="" type="checkbox"/>	
	Output F	<input checked="" type="checkbox"/>	
	Output G	<input checked="" type="checkbox"/>	
	Output H	<input checked="" type="checkbox"/>	
	Output I	<input checked="" type="checkbox"/>	
	Output J	<input checked="" type="checkbox"/>	
	Output K	<input checked="" type="checkbox"/>	
	Output L	<input checked="" type="checkbox"/>	
	Enable Logic/Threshold	Logic/Threshold 1-4	<input checked="" type="checkbox"/>
		Logic/Threshold 5-8	<input checked="" type="checkbox"/>
Logic/Threshold 9-12		<input checked="" type="checkbox"/>	
Logic/Threshold 13-16		<input type="checkbox"/>	
Logic/Threshold 17-20		<input type="checkbox"/>	
Logic/Threshold 21-24		<input type="checkbox"/>	
Maximum number of sent telegrams	20		
In period (0 = deactivated)	01	ss	
i-bus® Tool access	Full access		

Fig. 22: Parameter window Configuration

This parameter window includes the following parameters:

- [Enable output X, Page 84](#)
- [Enable Logic/Threshold x-y, Page 99](#)
- [Maximum number of sent telegrams, Page 99](#)
- [In period \(0 = deactivated\), Page 93](#)
- [i-bus® Tool access, Page 127](#)

Prerequisites for visibility

- The parameter window is always visible.

7.2.2 Parameter windows Device settings

The following settings can be made in this parameter window:

- Set sending and switching delay
- Enable Group Object [Request status values](#)
- Enable Group Object [In operation](#)
- Enable central and device-specific Group Objects

Configuration	Device settings
– Device settings	Sending and switching delay after bus voltage recovery <input type="text" value="00:00:02"/> hh:mm:ss
– Device settings	Value after sending and switching delay has expired <input checked="" type="radio"/> Last value received <input type="radio"/> Ignore received values
+ Safety	Enable Time group objects for setting of device time <input type="text" value="No"/>
+ Logic/Threshold	
+ Switch Actuator template	Enable group object "Request status values" <input type="checkbox"/>
+ Switch Actuator A:	Enable central group object "Switch" <input type="checkbox"/>
+ Switch Actuator B:	Enable central group object "Receive load shedding stage" <input checked="" type="checkbox"/>
+ Switch Actuator C:	Enable central group object "Scene 1 ... 64" <input type="checkbox"/>
+ Switch Actuator D:	
+ Switch Actuator E:	Enable group object "In operation" <input type="text" value="No"/>

Fig. 23: Parameter window Device settings

This parameter window includes the following parameters:

- [Sending and switching delay after bus voltage recovery, Page 108](#)
- [Value after sending and switching delay has expired, Page 125](#)
- [Enable Time Group Objects for setting of device time, Page 97](#)
 - [Request Date/Time via Group Object, Page 87](#)
- [Enable Group Object "Request status values", Page 95](#)
- [Enable central Group Object "Switch", Page 127](#)
- [Enable central Group Object "Receive load shedding stage", Page 126](#)
- [Enable central Group Object "Scene 1 ... 64", Page 127](#)
- [Enable Group Object "In operation", Page 94](#)
 - [Sending cycle, Page 108](#)

Prerequisites for visibility

- The parameter window is always visible.

7.2.3 Parameter windows Safety

The following settings can be made in this parameter window:

- Enable safety priorities

The safety priorities apply to the entire device, but each output can react differently to receipt of a safety priority. The reaction of the individual outputs can be defined in the respective parameter windows.

More information: → [Safety functions, Page 41.](#)

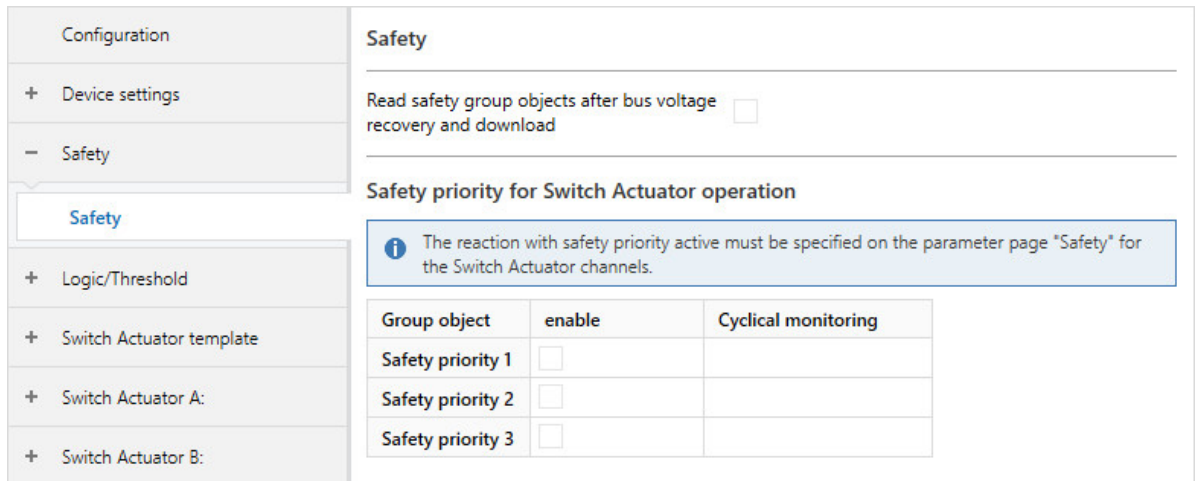

Fig. 24: Parameter window Safety

This parameter window includes the following parameters:

- [Read safety Group Objects after bus voltage recovery and download, Page 108](#)
- [Enable Group Object "Safety priority x", Page 94](#)
- [Cyclical monitoring, Page 128](#)

Prerequisites for visibility

- The parameter window is always visible.

7.2.4 Parameter windows Logic/Threshold

The functions *Logic* and *Threshold* can be set individually for each output in the subordinate parameter windows.

Prerequisites for visibility

- Parameter window *Configuration* \ Parameter *Enable Logic/Threshold x-y* \ Option Yes

7.2.4.1 Parameter windows Logic/Threshold x

The following settings can be made in this parameter window:

- Parameterize function *Logic*
- Parameterize function *Threshold*

The functions *Logic* and *Threshold* can be used independent of other functions. The results of the functions *Logic* and *Threshold* can be linked internally with any output (→ parameter *Output reacts to*) and/or sent on the bus (ABB i-bus® KNX).

More information → [Function Logic, Page 42](#), → [Function Threshold, Page 43](#).

Configuration	Logic
+ Device settings	Function of the logic gate AND ▼
+ Safety	Value of group object "Connection A" after bus voltage recovery <input type="radio"/> 1 <input checked="" type="radio"/> 0
- Logic/Threshold	Value of group object "Connection B" after bus voltage recovery <input type="radio"/> 1 <input checked="" type="radio"/> 0
Logic/Threshold 1	i Only when a value is received on one of the two group objects "Connection A" or "Connection B" the result is calculated.
Logic/Threshold 2	Read input group objects after bus voltage recovery and download <input type="checkbox"/>
Logic/Threshold 3	Invert result <input type="checkbox"/>
Logic/Threshold 4	Enable group object "Status result" <input type="checkbox"/>
Logic/Threshold 5	
Logic/Threshold 6	

Fig. 25: Parameter window Logic/Threshold x

This parameter window includes the following parameters:

- [Function of the logic gate, Page 90](#)
- [Value of Group Object "Connection A" after bus voltage recovery, Page 123](#)
- [Value of Group Object "Connection B" after bus voltage recovery, Page 124](#)
- [Read input Group Objects after bus voltage recovery and download, Page 88](#)
- [Invert result, Page 89](#)
- [Enable Group Object "Status Result", Page 94](#)
 - [Send value of Group Object "Status Result", Page 121](#)
- [GATE blocks if Group Object "Connection A" equals, Page 110](#)
- [Data point type of Group Object "Threshold input", Page 86](#)
- [Upper threshold, Page 101](#)
- [Lower threshold, Page 114](#)
- [Change thresholds via Group Objects, Page 107](#)
- [Change thresholds via i-bus® Tool, Page 107](#)
 - [Overwrite thresholds on download, Page 106](#)
- [Result if upper threshold is exceeded, Page 89](#)
- [Min. duration of the overshoot, Page 100](#)
- [Monitor range between thresholds, Page 85](#)
 - [Minimum dwell time between the thresholds, Page 100](#)
- [Result if lower threshold is dropped below, Page 90](#)
- [Min. duration of the undershoot, Page 100](#)
- [Read input Group Objects after bus voltage recovery and download, Page 88](#)
- [Enable Group Objects "Status Result" and "Status Input value between thresholds", Page 96](#)
 - [Send values of Group Objects "Status Result" and "Status Input value between thresholds", Page 125](#)

 Note

The interface to i-bus® Tool is available from the following software versions:

- Application from V1.2
- Firmware from V0.2.0

Prerequisites for visibility

- Parameter window [Configuration](#) \ Parameter [Enable Logic/Threshold x-y](#) \ Option *Yes*
- The parameter window is in the parameter window [Logic/Threshold](#).

7.2.5 Parameter windows Switch Actuator template

The functions can be set for all Switch Actuator outputs in this parameter window.

Note

It can be decided for each Switch Actuator output whether parameterization from the template is used. The individual setting for a Switch Actuator output is made in the respective parameter window [Switch Actuator X](#).

The parameterization options in the template and in the parameter window for the Switch Actuator output are identical. The following parameter windows are available in the template:

- [Basic settings \[Switch Actuator\]](#)
- [Safety](#)
- [Load shedding](#)
- [Delay for switching on and off](#)
- [Staircase lighting](#)
- [Flashing](#)
- [Scene assignments \[Switch Actuator\]](#)

Prerequisites for visibility

- The parameter window is always visible.

7.2.6 Parameter windows Switch Actuator X

The functions can be set individually for each Switch Actuator output in the subordinate parameter windows.

Note

If several Switch Actuator outputs are to be set to the same values, parameterization can be performed in the parameter window [Switch Actuator template](#).

Note

The layout in the parameter window is identical for all outputs. The settings are explained in the following based on examples.

Prerequisites for visibility

- Parameter window [Configuration](#) \ Parameter [Enable output X](#) \ Option *Yes*

7.2.6.1 Parameter windows Functions Switch Actuator

The following settings can be made in this parameter window:

- Enable functions
- Connect output to the functions *Logic* and *Threshold*

Configuration	Functions switch actuator
+ Device settings	Designation <input type="text"/>
+ Safety	Enable function Safety <input type="checkbox"/>
+ Logic/Threshold	Enable function Time <input type="text" value="No"/>
+ Switch Actuator template	Enable function Scenes <input type="checkbox"/>
+ Switch Actuator A:	Enable function Load shedding <input type="checkbox"/>
Functions switch actuator	Output reacts to <input type="text" value="No Logic/Threshold function"/>
Basic settings	i The function "Logic/Threshold" can be enabled on the "Logic/Threshold" parameter page.

Fig. 26: Parameter window Functions

This parameter window includes the following parameters:

- [Description, Page 85](#)
- [Enable function Safety, Page 92](#)
- [Enable function Time, Page 93](#)
- [Enable function Scenes \[Switch Actuator\], Page 92](#)
- [Enable function Load shedding, Page 92](#)
- [Output reacts to, Page 84](#)
 - [Reaction on result "0" \[Switch Actuator\], Page 115](#)
 - [Reaction on result "1" \[Switch Actuator\], Page 115](#)

Prerequisites for visibility

- Parameter window *Configuration* \ Parameter *Enable output X* \ Option *Yes*
- The parameter window is in the parameter window *Switch Actuator X*.

7.2.6.2 Parameter windows Basic settings [Switch Actuator]

Note

If several Switch Actuator outputs are to be set to the same values, parameterization can be performed in the parameter window [Switch Actuator template](#).

The following settings can be made in this parameter window:

- Reaction of output (normally closed/normally opened contact)
- Connect output to the central Group Object [Switch](#)
- Enable and configure status information
- Configure reaction on bus voltage failure, after bus voltage recovery and after download

Configuration	Basic settings
+ Device settings	Parameter setting <input type="radio"/> Apply from template <input checked="" type="radio"/> Individual
+ Safety	Reaction of output <input type="radio"/> Normally closed <input checked="" type="radio"/> Normally opened
+ Logic/Threshold	Feedback of contact position via group object "Status switch" <input checked="" type="checkbox"/>
+ Switch Actuator template	Value of group object "Status switch" <input checked="" type="radio"/> 1: closed, 0: opened <input type="radio"/> 0: closed, 1: opened
- Switch Actuator A:	Send value of group object "Status switch" <input type="text" value="At change or on request"/>
Functions switch actuator	Enable group object "Status byte" <input type="text" value="No"/>
Basic settings	
+ Switch Actuator B:	Switching reaction on bus voltage failure <input type="text" value="Contact unchanged"/>
+ Switch Actuator C:	Reaction after bus voltage recovery <input type="text" value="Calculate contact position"/>
+ Switch Actuator D:	Reaction after ETS download <input type="text" value="Switch only if safety functions active"/>
+ Switch Actuator E:	i Safety functions are taken into account.

Fig. 27: Parameter window Basic settings

This parameter window includes the following parameters:

- [Parameter setting, Page 101](#)
- [Reaction of output, Page 116](#)
- [Switch output reacts to central Switch Group Object, Page 102](#)
- [Feedback of contact position via Group Object "Status Switch", Page 101](#)
- [Value of Group Object "Status Switch", Page 122](#)
- [Send value of Group Object "Status Switch", Page 123](#)
- [Enable Group Objects "Status byte" \[Switch Actuator\], Page 96](#)
- [Send value of Group Objects "Status byte" \[Switch Actuator\], Page 124](#)
- [Switching reaction on bus voltage failure, Page 103](#)
- [Reaction after bus voltage recovery \[Switch Actuator\], Page 117](#)
- [Reaction after ETS download \[Switch Actuator\], Page 118](#)

Prerequisites for visibility

- Parameter window [Configuration](#) \ Parameter [Enable output X](#) \ Option Yes
- The parameter window is in the parameter window [Switch Actuator X](#).

7.2.6.3 Parameter windows Safety

Note

If several Switch Actuator outputs are to be set to the same values, parameterization can be performed in the parameter window [Switch Actuator template](#).

The following settings can be made in this parameter window:

- Parameterize reaction to safety priorities, forced operation and block

More information: → [Switch Actuator safety functions, Page 41](#).

Configuration	Safety
+ Device settings	Parameter setting <input type="radio"/> Apply from template <input checked="" type="radio"/> Individual
+ Safety	
+ Logic/Threshold	
+ Switch Actuator template	
- Switch Actuator A:	
Functions switch actuator	
Basic settings	
Safety	

i The group objects "Safety priority 1-3" can be enabled on the parameter page "Safety". The order specifies the priority of the safety functions.

Forced operation (1 bit/2 bit)	Deactivated
Switching reaction on block	No reaction/deactivated
Switching reaction on cancellation of block, forced operation, and safety priority	No reaction

Fig. 28: Parameter window Safety

This parameter window includes the following parameters:

- [Parameter setting, Page 101](#)
- [Switching reaction on safety priority x, Page 104](#)
- [Forced operation \(1 bit / 2 bit\) \[Switch Actuator\], Page 128](#)
- [Switching reaction on forced operation, Page 106](#)
- [Switching reaction on block, Page 105](#)
- [Switching reaction on cancellation of block, forced operation and safety priority, Page 104](#)

Prerequisites for visibility

- Parameter window [Configuration](#) \ Parameter [Enable output X](#) \ Option Yes
- Parameter window [Switch Actuator X](#) \ Parameter window [Functions Switch Actuator](#) \ Parameter [Enable function Safety](#) \ Option Yes
- The parameter window is in the parameter window [Switch Actuator X](#).

7.2.6.4 Parameter windows Load shedding

Note

If several Switch Actuator outputs are to be set to the same values, parameterization can be performed in the parameter window [Switch Actuator template](#).

The following settings can be made in this parameter window:

- Parameterize function *Load shedding*

More information: → [Function Load shedding, Page 45](#).

Fig. 29: Parameter window Load shedding

This parameter window includes the following parameters:

- [Parameter setting, Page 101](#)
- [Load shedding stage, Page 97](#)
- [Change load shedding stage via Group Object, Page 99](#)
- [Overwrite load shedding stage at download, Page 98](#)
- [Change load shedding stage via i-bus® Tool, Page 98](#)
- [Switching reaction on active load shedding stage, Page 102](#)
- [Switching reaction on revoke of load shedding stage, Page 103](#)
- [Enable group object "Status Load shedding", Page 95](#)
- [Send value of Group Object "Status Load shedding", Page 122](#)

Note

The interface to i-bus® Tool is available from the following software versions:

- Application from V1.2
- Firmware from V0.2.0

Prerequisites for visibility

- Parameter window [Configuration](#) \ Parameter [Enable output X](#) \ Option Yes
- Parameter window [Device settings](#) \ Parameter [Enable central Group Object "Receive load shedding stage"](#) \ Option Yes
- Parameter window [Switch Actuator X](#) \ Parameter window [Functions Switch Actuator](#) \ Parameter [Enable function Load shedding](#) \ Option Yes
- The parameter window is in the parameter window [Switch Actuator X](#).

7.2.6.5 Parameter windows Staircase lighting

Note
 If several Switch Actuator outputs are to be set to the same values, parameterization can be performed in the parameter window *Switch Actuator template*.

The following settings can be made in this parameter window:

- Parameterize function *Staircase lighting*

More information: → [Function Staircase lighting, Page 52](#).

Note
 If a delay is used for Scene recall (→ parameter *Delay*), the output does not react to the functions *Staircase lighting* and *Delay for switching on and off* → [Function diagram Switch Actuator, Page 40](#).

Configuration	Staircase lighting	
+ Device settings	Parameter setting	<input type="radio"/> Apply from template <input checked="" type="radio"/> Individual
+ Safety	Staircase lighting time	<input type="text" value="00:05:00"/> hh:mm:ss
+ Logic/Threshold	Staircase lighting time can be started again	<input checked="" type="checkbox"/>
+ Switch Actuator template	Staircase lighting time extendable (pumping)	No, can only be started again ▼
- Switch Actuator A:	Switching reaction of staircase lighting on telegram value 0/1	On with "1" and off with "0" ▼
Functions switch actuator	Warning before switching off the staircase lighting	No ▼
Basic settings	Disable staircase lighting via group object	<input type="checkbox"/>
Staircase lighting	Change staircase lighting time via group object	<input type="checkbox"/>
+ Switch Actuator B:	Change staircase lighting time via i-bus Tool	<input type="checkbox"/>
+ Switch Actuator C:	Restart staircase lighting time after permanent ON	<input type="checkbox"/>

Fig. 30: Parameter window Staircase lighting

This parameter window includes the following parameters:

- [Parameter setting, Page 101](#)
- [Staircase lighting time, Page 111](#)
- [Staircase lighting time can be started again, Page 112](#)
 - [Staircase lighting time extendable \(pumping\), Page 114](#)
- [Switching reaction of staircase lighting on telegram value 0/1, Page 110](#)
- [Warning before switching off the staircase lighting, Page 120](#)
 - [Number of Off/On changes, Page 83](#)
 - [Warning time, Page 121](#)
- [Block staircase lighting via Group Object, Page 111](#)
 - [Block staircase lighting after bus voltage recovery, Page 110](#)
- [Change staircase lighting time via Group Object, Page 113](#)
 - [Overwrite staircase lighting time on download, Page 111](#)
- [Change staircase lighting time via i-bus® Tool, Page 113](#)
- [Restart staircase lighting time after permanent on, Page 112](#)

Prerequisites for visibility

- Parameter window [Configuration](#) \ Parameter [Enable output X](#) \ Option *Yes*
- Parameter window [Switch Actuator X](#) \ Parameter window [Functions Switch Actuator](#) \ Parameter [Enable function Time](#) \ Option *Staircase lighting*
- The parameter window is in the parameter window [Switch Actuator X](#).

7.2.6.6 Parameter windows Delay for switching on and off

Note

If several Switch Actuator outputs are to be set to the same values, parameterization can be performed in the parameter window [Switch Actuator template](#).

The following settings can be made in this parameter window:

- Parameterize function *Delay for switching on and off*

More information: → [Function Delay for switching on and off, Page 54](#).

Note

If a delay is used for Scene recall (→ parameter [Delay](#)), the output does not react to the functions *Staircase lighting* and *Delay for switching on and off* → [Function diagram Switch Actuator, Page 40](#).

Configuration	Delay for switching on and off
+ Device settings	Parameter setting <input type="radio"/> Apply from template <input checked="" type="radio"/> Individual
+ Safety	
+ Logic/Threshold	Delay for switching on <input type="text" value="00:00:00"/> hh:mm:ss
+ Switch Actuator template	Delay for switching off <input type="text" value="00:00:00"/> hh:mm:ss
- Switch Actuator A:	Disable delay for switching on and off via group object <input type="checkbox"/>
Functions switch actuator	
Basic settings	
Delay for switching on and off	

Fig. 31: Parameter window Delay for switching on and off

This parameter window includes the following parameters:

- [Parameter setting, Page 101](#)
- [Delay for switching on, Page 89](#)
- [Delay for switching off, Page 85](#)
- [Block delay for switching on and off via Group Object, Page 87](#)
- [Block delay for switching on and off after bus voltage recovery, Page 87](#)

Prerequisites for visibility

- Parameter window [Configuration](#) \ Parameter [Enable output X](#) \ Option Yes
- Parameter window [Switch Actuator X](#) \ Parameter window [Functions Switch Actuator](#) \ Parameter [Enable function Time](#) \ Option [Delay for switching on and off](#)
- The parameter window is in the parameter window [Switch Actuator X](#).

7.2.6.7 Parameter windows Flashing

Note

If several Switch Actuator outputs are to be set to the same values, parameterization can be performed in the parameter window [Switch Actuator template](#).

The following settings can be made in this parameter window:

- Parameterize function *Flashing*

More information: → [Function Flashing, Page 55](#).

Note

Each relay can perform only a limited number of switching operations per minute → Technical data. A large number of switching operations per minute can delay switching.

Note

If the function *Flashing* is used:

- Pay attention to the service life of the lighting equipment.
- Take into account the service life of the switching contacts → Technical data.

Configuration	Flashing
+ Device settings	Parameter setting <input type="radio"/> Apply from template <input checked="" type="radio"/> Individual
+ Safety	Flashing if group object "Flashing" is <input type="text" value="On (1) or off (0)"/>
+ Logic/Threshold	Time for on <input type="text" value="00:00:05"/> hh:mm:ss
+ Switch Actuator template	Time for off <input type="text" value="00:00:05"/> hh:mm:ss
- Switch Actuator A:	Number of flashing cycles <input type="text" value="5"/>
Functions switch actuator	Reaction after flashing <input type="text" value="Refreshed KNX state"/>
Basic settings	Note Observe the contact life and switching cycles per minute. For more information, see product manual.
Flashing	

Fig. 32: Parameter window Flashing

This parameter window includes the following parameters:

- [Parameter setting, Page 101](#)
- [Flashing if Group Object "Flashing" is, Page 86](#)
- [Time for on, Page 126](#)
- [Time for off, Page 126](#)
- [Number of flashing cycles, Page 83](#)
- [Reaction after flashing, Page 117](#)

Prerequisites for visibility

- Parameter window [Configuration](#) \ Parameter [Enable output X](#) \ Option Yes
- Parameter window [Switch Actuator X](#) \ Parameter window [Functions Switch Actuator](#) \ Parameter [Enable function Time](#) \ Option *Flashing*
- The parameter window is in the parameter window [Switch Actuator X](#).

7.2.6.8 Parameter windows Scene assignments [Switch Actuator]

Note

If several Switch Actuator outputs are to be set to the same values, parameterization can be performed in the parameter window *Switch Actuator template*.

The following settings can be made in this parameter window:

- Enable Scene assignments
- Create Scenes

More information: → [Function Scenes, Page 50](#).

Configuration

- + Device settings
- + Safety
- + Logic/Threshold
- + Switch Actuator template
- Switch Actuator A:
 - Functions switch actuator
 - Basic settings
 - Scene assignments
- + Switch Actuator B:
- + Switch Actuator C:
- + Switch Actuator D:
- + Switch Actuator E:
- + Switch Actuator F:
- + Switch Actuator G:
- + Switch Actuator H:
- + Switch Actuator I:
- + Switch Actuator J:

Scene assignments

Parameter setting Apply from template Individual

Overwrite scenes on download

Scene assignment	enable	Scene number	Delay	Reaction on scene recall
1	<input checked="" type="checkbox"/>	1	00:00:00 hh:mm:ss	<input checked="" type="radio"/> On <input type="radio"/> Off
2	<input type="checkbox"/>			
3	<input type="checkbox"/>			
4	<input type="checkbox"/>			
5	<input type="checkbox"/>			
6	<input type="checkbox"/>			
7	<input type="checkbox"/>			
8	<input type="checkbox"/>			
9	<input type="checkbox"/>			
10	<input type="checkbox"/>			
11	<input type="checkbox"/>			
12	<input type="checkbox"/>			
13	<input type="checkbox"/>			
14	<input type="checkbox"/>			
15	<input type="checkbox"/>			
16	<input type="checkbox"/>			

i If delay not equal to 0, there is no staircase lighting and no delay for switching on and off.

Scene 1 recall also via 1 bit group object

Fig. 33: Parameter window Scene assignment

This parameter window includes the following parameters:

- [Parameter setting, Page 101](#)
- [Overwrite Scenes on download, Page 109](#)
- [Enable Scene assignment x \[Switch Actuator\], Page 109](#)
 - [Scene number, Page 109](#)
 - [Delay, Page 120](#)
 - [Reaction on Scene recall, Page 116](#)
 - [Recall Scene x also via 1-bit Group Object, Page 83](#)

Prerequisites for visibility

- Parameter window [Configuration](#) \ Parameter [Enable output X](#) \ Option Yes
- Parameter window [Switch Actuator X](#) \ Parameter window [Functions Switch Actuator](#) \ Parameter [Enable function Scenes \[Switch Actuator\]](#) \ Option Yes
- The parameter window is in the parameter window [Switch Actuator X](#).

7.3 Overview of parameters

- [Block delay for switching on and off after bus voltage recovery, Page 87](#)
- [Block delay for switching on and off via Group Object, Page 87](#)
- [Block staircase lighting after bus voltage recovery, Page 110](#)
- [Block staircase lighting via Group Object, Page 111](#)
- [Change load shedding stage via Group Object, Page 99](#)
- [Change load shedding stage via i-bus® Tool, Page 98](#)
- [Change staircase lighting time via Group Object, Page 113](#)
- [Change staircase lighting time via i-bus® Tool, Page 113](#)
- [Change thresholds via Group Objects, Page 107](#)
- [Change thresholds via i-bus® Tool, Page 107](#)
- [Cyclical monitoring, Page 128](#)
- [Data point type of Group Object "Threshold input", Page 86](#)
- [Delay for switching off, Page 85](#)
- [Delay for switching on, Page 89](#)
- [Delay, Page 120](#)
- [Description, Page 85](#)
- [Enable central Group Object "Receive load shedding stage", Page 126](#)
- [Enable central Group Object "Scene 1 ... 64", Page 127](#)
- [Enable central Group Object "Switch", Page 127](#)
- [Enable function Load shedding, Page 92](#)
- [Enable function Safety, Page 92](#)
- [Enable function Scenes \[Switch Actuator\], Page 92](#)
- [Enable function Time, Page 93](#)
- [Enable Group Object "In operation", Page 94](#)
- [Enable Group Object "Request status values", Page 95](#)
- [Enable Group Object "Safety priority x", Page 94](#)
- [Enable group object "Status Load shedding", Page 95](#)
- [Enable Group Object "Status Result", Page 94](#)
- [Enable Group Objects "Status byte" \[Switch Actuator\], Page 96](#)
- [Enable Group Objects "Status Result" and "Status Input value between thresholds", Page 96](#)
- [Enable Logic/Threshold x-y, Page 99](#)
- [Enable output X, Page 84](#)
- [Enable Scene assignment x \[Switch Actuator\], Page 109](#)
- [Enable Time Group Objects for setting of device time, Page 97](#)
- [Feedback of contact position via Group Object "Status Switch", Page 101](#)
- [Flashing if Group Object "Flashing" is, Page 86](#)
- [Forced operation \(1 bit / 2 bit\) \[Switch Actuator\], Page 128](#)
- [Function of the logic gate, Page 90](#)
- [GATE blocks if Group Object "Connection A" equals, Page 110](#)
- [i-bus® Tool access, Page 127](#)
- [In period \(0 = deactivated\), Page 93](#)
- [Invert result, Page 89](#)
- [Load shedding stage, Page 97](#)
- [Lower threshold, Page 114](#)
- [Maximum number of sent telegrams, Page 99](#)
- [Min. duration of the overshoot, Page 100](#)
- [Min. duration of the undershoot, Page 100](#)
- [Minimum dwell time between the thresholds, Page 100](#)
- [Monitor range between thresholds, Page 85](#)
- [Number of flashing cycles, Page 83](#)
- [Number of Off/On changes, Page 83](#)
- [Output reacts to, Page 84](#)
- [Overwrite load shedding stage at download, Page 98](#)
- [Overwrite Scenes on download, Page 109](#)
- [Overwrite staircase lighting time on download, Page 111](#)
- [Overwrite thresholds on download, Page 106](#)

- [Parameter setting, Page 101](#)
- [Reaction after bus voltage recovery \[Switch Actuator\], Page 117](#)
- [Reaction after ETS download \[Switch Actuator\], Page 118](#)
- [Reaction after flashing, Page 117](#)
- [Reaction of output, Page 116](#)
- [Reaction on result "0" \[Switch Actuator\], Page 115](#)
- [Reaction on result "1" \[Switch Actuator\], Page 115](#)
- [Reaction on Scene recall, Page 116](#)
- [Read input Group Objects after bus voltage recovery and download, Page 88](#)
- [Read safety Group Objects after bus voltage recovery and download, Page 108](#)
- [Recall Scene x also via 1-bit Group Object, Page 83](#)
- [Request Date/Time via Group Object, Page 87](#)
- [Restart staircase lighting time after permanent on, Page 112](#)
- [Result if lower threshold is dropped below, Page 90](#)
- [Result if upper threshold is exceeded, Page 89](#)
- [Scene number, Page 109](#)
- [Send value of Group Object "Status Load shedding", Page 122](#)
- [Send value of Group Object "Status Result", Page 121](#)
- [Send value of Group Object "Status Switch", Page 123](#)
- [Send value of Group Objects "Status byte" \[Switch Actuator\], Page 124](#)
- [Send values of Group Objects "Status Result" and "Status Input value between thresholds", Page 125](#)
- [Sending and switching delay after bus voltage recovery, Page 108](#)
- [Sending cycle, Page 108](#)
- [Staircase lighting time can be started again, Page 112](#)
- [Staircase lighting time extendable \(pumping\), Page 114](#)
- [Staircase lighting time, Page 111](#)
- [Switch output reacts to central Switch Group Object, Page 102](#)
- [Switching reaction of staircase lighting on telegram value 0/1, Page 110](#)
- [Switching reaction on active load shedding stage, Page 102](#)
- [Switching reaction on block, Page 105](#)
- [Switching reaction on bus voltage failure, Page 103](#)
- [Switching reaction on cancellation of block, forced operation and safety priority, Page 104](#)
- [Switching reaction on forced operation, Page 106](#)
- [Switching reaction on revoke of load shedding stage, Page 103](#)
- [Switching reaction on safety priority x, Page 104](#)
- [Time for off, Page 126](#)
- [Time for on, Page 126](#)
- [Upper threshold, Page 101](#)
- [Value after sending and switching delay has expired, Page 125](#)
- [Value of Group Object "Connection A" after bus voltage recovery, Page 123](#)
- [Value of Group Object "Connection B" after bus voltage recovery, Page 124](#)
- [Value of Group Object "Status Switch", Page 122](#)
- [Warning before switching off the staircase lighting, Page 120](#)
- [Warning time, Page 121](#)

7.4 Parameter descriptions

7.4.1 Number of Off/On changes

This parameter is used to define the number of Off/On changes during the warning time.

Option

1... 2... 5

Prerequisites for visibility

- Parameter window [Configuration](#) \ Parameter [Enable output X](#) \ Option *Yes*
- Parameter window [Switch Actuator X](#) \ Parameter window [Functions Switch Actuator](#) \ Parameter [Enable function Time](#) \ Option *Staircase lighting*
- Parameter window [Switch Actuator X](#) \ Parameter window [Staircase lighting](#)
 - Parameter [Parameter setting](#) \ Option *Individual*
 - Parameter [Warning before switching off the staircase lighting](#) \ Option *Short switching off / Via Group Object and short switching off*
- The parameter is in the parameter window [Switch Actuator X](#) \ parameter window [Staircase lighting](#).

7.4.2 Number of flashing cycles

This parameter is used to define the number of flashing cycles. A flashing cycle consists of one On/Off change.

Option

0... 5... 100

Prerequisites for visibility

- Parameter window [Configuration](#) \ Parameter [Enable output X](#) \ Option *Yes*
- Parameter window [Switch Actuator X](#) \ Parameter window [Functions Switch Actuator](#) \ Parameter [Enable function Time](#) \ Option *Flashing*
- Parameter window [Switch Actuator X](#) \ Parameter window [Flashing](#) \ Parameter [Parameter setting](#) \ Option *Individual*
- The parameter is in the parameter window [Switch Actuator X](#) \ parameter window [Flashing](#).

7.4.3 Recall Scene x also via 1-bit Group Object

Note

This parameter is available only for the Scene assignments 1 ... 4.

This parameter is used to define whether it is possible to recall the Scene assignment also via the Group Object *Recall Scene assignment x*.

Option	
<i>No</i>	It is not possible to recall the Scene assignment via Group Object.
<i>Yes</i>	The following dependent Group Objects are displayed: <ul style="list-style-type: none"> • <i>Recall Scene assignment x</i>

Prerequisites for visibility

- Parameter window *Configuration* \ Parameter *Enable output X* \ Option *Yes*
- Parameter window *Switch Actuator X* \ Parameter window *Functions Switch Actuator* \ Parameter *Enable function Scenes [Switch Actuator]* \ Option *Yes*
- Parameter window *Switch Actuator X* \ Parameter window *Scene assignments [Switch Actuator]*
 - Parameter *Parameter setting* \ Option *Individual*
 - Parameter *Enable Scene assignment x [Switch Actuator]* \ Option *Yes*
- The parameter is in the parameter window *Switch Actuator X* \ parameter window *Scene assignments [Switch Actuator]*.

7.4.4

Output reacts to

This parameter is used to define whether the output reacts to the result of a Logic or Threshold function.

More information → [Function Logic, Page 42](#), → [Function Threshold, Page 43](#).

Option	
<i>No Logic/Threshold function</i>	The output does not react to the result of a <i>Logic</i> or <i>Threshold</i> function.
<i>Logic/Threshold x</i>	The output reacts to the result of the function <i>Logic/Threshold x</i> ($x = 1 \dots 24$). <p>The following dependent parameters are shown:</p> <ul style="list-style-type: none"> • <i>Reaction on result "0" [Switch Actuator]</i> • <i>Reaction on result "1" [Switch Actuator]</i>

Prerequisites for visibility

- Parameter window *Configuration* \ Parameter *Enable output X* \ Option *Yes*
- The parameter is in the parameter window *Switch Actuator X* \ parameter window *Functions Switch Actuator*.

7.4.5

Enable output X

These parameters enable the device outputs. The enabled outputs are configured in the parameter window *Switch Actuator X*.

Option	
<i>No</i>	The outputs are not enabled.
<i>Yes</i>	The following dependent parameter windows are shown: <ul style="list-style-type: none"> • <i>Switch Actuator X</i> • <i>Functions Switch Actuator</i> • <i>Basic settings [Switch Actuator]</i>

Prerequisites for visibility

- The parameter is in the parameter window *Configuration*.

7.4.6 Delay for switching off

This parameter is used to define the switch-off delay for the output after an Off telegram is received.

More information: → [Function Delay for switching on and off, Page 54.](#)

Option	
<u>00:00:00</u> ...	18:12:15 hh:mm:ss

Prerequisites for visibility

- Parameter window [Configuration](#) \ Parameter [Enable output X](#) \ Option Yes
- Parameter window [Switch Actuator X](#) \ Parameter window [Functions Switch Actuator](#) \ Parameter [Enable function Time](#) \ Option [Delay for switching on and off](#)
- Parameter window [Switch Actuator X](#) \ Parameter window [Delay for switching on and off](#) \ Parameter [Parameter setting](#) \ Option [Individual](#)
- The parameter is in the parameter window [Switch Actuator X](#) \ parameter window [Delay for switching on and off](#).

7.4.7 Monitor range between thresholds

This parameter is used to define whether the range between the thresholds is monitored and evaluated via the Group Object [Status Input value between thresholds](#).

Option	
<u>No</u>	The range between the thresholds is not monitored and evaluated.
<u>Yes</u>	The following dependent parameters are shown: <ul style="list-style-type: none"> • Minimum dwell time between the thresholds

Prerequisites for visibility

- Parameter window [Configuration](#) \ Parameter [Enable Logic/Threshold x-y](#) \ Option Yes
- Parameter window [Logic/Threshold](#) \ Parameter window [Logic/Threshold x](#) \ Parameter [Function of the logic gate](#) \ Option [Threshold](#)
- The parameter is in the parameter window [Logic/Threshold](#) \ parameter window [Logic/Threshold x](#).

7.4.8 Description

This parameter is used to define a description of an output, a channel or a group. The description is displayed at the following points:

- In i-bus® Tool
- In the name of the corresponding parameter window
- In the name of the corresponding Group Objects

Note

The interface to i-bus® Tool is available from the following software versions:

- Application from V1.2
- Firmware from V0.2.0

Option	
<u>Free text entry</u>	Maximum 24 ASCII characters; the maximum number of characters may vary for other character formats.

Prerequisites for visibility

- The parameter appears at various points in the application. The visibility is dependent on the application and the higher-level parameter.

7.4.9 Flashing if Group Object "Flashing" is

This parameter is used to set the telegram value with which flashing is started and prematurely ended.

Option	
<i>On (1) or off (0)</i>	A telegram with the value 1 or 0 starts the flashing. Flashing cannot be ended prematurely.
<i>On (1)</i>	A telegram with the value 1 starts the flashing. A telegram with the value 0 ends flashing.
<i>Off (0)</i>	A telegram with the value 0 starts the flashing. A telegram with the value 1 ends flashing.

Prerequisites for visibility

- Parameter window [Configuration](#) \ Parameter [Enable output X](#) \ Option [Yes](#)
- Parameter window [Switch Actuator X](#) \ Parameter window [Functions Switch Actuator](#) \ Parameter [Enable function Time](#) \ Option [Flashing](#)
- Parameter window [Switch Actuator X](#) \ Parameter window [Flashing](#) \ Parameter [Parameter setting](#) \ Option [Individual](#)
- The parameter is in the parameter window [Switch Actuator X](#) \ parameter window [Flashing](#).

7.4.10 Data point type of Group Object "Threshold input"

This parameter is used to define the data point type that is received via the Group Object "Threshold input" and evaluated.

Option	
<i>Percent (DPT 5.001)</i>	The following dependent Group Objects are displayed: <ul style="list-style-type: none"> • Threshold input (DPT 5.001)
<i>Meter pulses (DPT 5.010)</i>	The following dependent Group Objects are displayed: <ul style="list-style-type: none"> • Threshold input (DPT 5.010)
<i>Meter pulses (DPT 7.001)</i>	The following dependent Group Objects are displayed: <ul style="list-style-type: none"> • Threshold input (DPT 7.001)
<i>Temperature (DPT 9.001)</i>	The following dependent Group Objects are displayed: <ul style="list-style-type: none"> • Threshold input (DPT 9.001)
<i>Lux (DPT 9.004)</i>	The following dependent Group Objects are displayed: <ul style="list-style-type: none"> • Threshold input (DPT 9.004)
<i>mA (DPT 9.021)</i>	The following dependent Group Objects are displayed: <ul style="list-style-type: none"> • Threshold input (DPT 9.021)
<i>A (DPT 14.019)</i>	The following dependent Group Objects are displayed: <ul style="list-style-type: none"> • Threshold input (DPT 14.019)
<i>W (DPT 14.056)</i>	The following dependent Group Objects are displayed: <ul style="list-style-type: none"> • Threshold input (DPT 14.056)
<i>kW (DPT 9.024)</i>	The following dependent Group Objects are displayed: <ul style="list-style-type: none"> • Threshold input (DPT 9.024)
<i>Wh (DPT 13.010)</i>	The following dependent Group Objects are displayed: <ul style="list-style-type: none"> • Threshold input (DPT 13.010)
<i>kWh (DPT 13.013)</i>	The following dependent Group Objects are displayed: <ul style="list-style-type: none"> • Threshold input (DPT 13.013)

Prerequisites for visibility

- Parameter window [Configuration](#) \ Parameter [Enable Logic/Threshold x-y](#) \ Option [Yes](#)
- Parameter window [Logic/Threshold](#) \ Parameter window [Logic/Threshold x](#) \ Parameter [Function of the logic gate](#) \ Option [Threshold](#)
- The parameter is in the parameter window [Logic/Threshold](#) \ parameter window [Logic/Threshold x](#).

7.4.11 Request Date/Time via Group Object

This parameter is used to define whether a date and time request is sent via the Group Object *Request Date/Time*.

Option	
<i>No</i>	The request is not sent.
<i>Yes</i>	The request is sent 30 seconds after switching on the device. An active send and switching delay is not taken into account.

Prerequisites for visibility

- Parameter window *Device settings* \ Parameter *Enable Time Group Objects for setting of device time* \ all options except *No*
- The parameter is in the parameter window *Device settings*.

7.4.12 Block delay for switching on and off after bus voltage recovery

This parameter is used to define whether the function *Delay for switching on and off* is blocked after bus voltage recovery.

Option	
<i>No</i>	
<i>Yes</i>	

Prerequisites for visibility

- Parameter window *Configuration* \ Parameter *Enable output X* \ Option *Yes*
- Parameter window *Switch Actuator X* \ Parameter window *Functions Switch Actuator* \ Parameter *Enable function Time* \ Option *Delay for switching on and off*
- Parameter window *Switch Actuator X* \ Parameter window *Delay for switching on and off*
 - Parameter *Parameter setting* \ Option *Individual*
 - Parameter *Block delay for switching on and off via Group Object* \ Option *Yes*
- The parameter is in the parameter window *Switch Actuator X* \ parameter window *Delay for switching on and off*.

7.4.13 Block delay for switching on and off via Group Object

This parameter is used to define whether the function *Delay for switching on and off* can be blocked via a Group Object.

If the function *Delay for switching on and off* is blocked, the switch-on command is forwarded without time function in the function chain. The output reacts according to its parameterization. After a download, the function *Delay for switching on and off* remains blocked.

Option	
<i>No</i>	The delay for switching on and off cannot be blocked via a Group Object.
<i>Yes</i>	The following dependent parameters are shown: <ul style="list-style-type: none"> • Block delay for switching on and off after bus voltage recovery The following dependent Group Objects are displayed: <ul style="list-style-type: none"> • Block delay for switching on and off

Prerequisites for visibility

- Parameter window [Configuration](#) \ Parameter [Enable output X](#) \ Option *Yes*
- Parameter window [Switch Actuator X](#) \ Parameter window [Functions Switch Actuator](#) \ Parameter [Enable function Time](#) \ Option *Delay for switching on and off*
- Parameter window [Switch Actuator X](#) \ Parameter window [Delay for switching on and off](#) \ Parameter [Parameter setting](#) \ Option *Individual*
- The parameter is in the parameter window [Switch Actuator X](#) \ parameter window [Delay for switching on and off](#).

7.4.14 Read input Group Objects after bus voltage recovery and download

This parameter is used to define whether the following input Group Objects are read after bus voltage recovery or download:

- [Connection A](#)
- [Connection B](#)
- [Threshold input](#) (DPT 5.001)
- [Threshold input](#) (DPT 5.010)
- [Threshold input](#) (DPT 7.001)
- [Threshold input](#) (DPT 9.001)
- [Threshold input](#) (DPT 9.004)

Note

To update the Group Objects after bus voltage recovery and download, the read flags must be set for the corresponding Group Objects of the sending device.

Option	
<i>No</i>	The input Group Objects are not read. The results of the functions <i>Logic</i> and <i>Threshold</i> are recalculated only if a new value is received on one of the input Group Objects.
<i>Yes</i>	The input Group Objects are read. The results of the functions <i>Logic</i> and <i>Threshold</i> are recalculated.

Prerequisites for visibility

- Parameter window [Configuration](#) \ Parameter [Enable Logic/Threshold x-y](#) \ Option *Yes*
- Parameter window [Logic/Threshold](#) \ Parameter window [Logic/Threshold x](#) \ Parameter [Function of the logic gate](#) \ all options except *None*
- The parameter is in the parameter window [Logic/Threshold](#) \ parameter window [Logic/Threshold x](#).

7.4.15 Delay for switching on

This parameter is used to define the switch-on delay for the output after an On telegram is received.

More information: → [Function Delay for switching on and off, Page 54.](#)

Option
<i>00:00:00... 18:12:15 hh:mm:ss</i>

Prerequisites for visibility

- Parameter window [Configuration](#) \ Parameter [Enable output X](#) \ Option Yes
- Parameter window [Switch Actuator X](#) \ Parameter window [Functions Switch Actuator](#) \ Parameter [Enable function Time](#) \ Option [Delay for switching on and off](#)
- Parameter window [Switch Actuator X](#) \ Parameter window [Delay for switching on and off](#) \ Parameter [Parameter setting](#) \ Option [Individual](#)
- The parameter is in the parameter window [Switch Actuator X](#) \ parameter window [Delay for switching on and off](#).

7.4.16 Invert result

This parameter is used to define whether the result of the function *Logic* is output inverted.

Option
<i>No</i>
<i>Yes</i>

Prerequisites for visibility

- Parameter window [Configuration](#) \ Parameter [Enable Logic/Threshold x-y](#) \ Option Yes
- Parameter window [Logic/Threshold](#) \ Parameter window [Logic/Threshold x](#) \ Parameter [Function of the logic gate](#) \ Options [AND](#) / [OR](#) / [Exclusive OR](#) / [GATE](#)
- The parameter is in the parameter window [Logic/Threshold](#) \ parameter window [Logic/Threshold x](#).

7.4.17 Result if upper threshold is exceeded

This parameter is used to define the result of the function *Threshold* when the value received at the threshold input exceeds the upper threshold.

The result can be linked with any output within the device or output on the Group Object [Status Result \[Threshold\]](#).

Option	
<i>Unchanged</i>	The result of the function <i>Threshold</i> remains unchanged.
<i>1</i>	The result of the function <i>Threshold</i> is 1.
<i>0</i>	The result of the function <i>Threshold</i> is 0.

Prerequisites for visibility

- Parameter window [Configuration](#) \ Parameter [Enable Logic/Threshold x-y](#) \ Option Yes
- Parameter window [Logic/Threshold](#) \ Parameter window [Logic/Threshold x](#) \ Parameter [Function of the logic gate](#) \ Option [Threshold](#)
- The parameter is in the parameter window [Logic/Threshold](#) \ parameter window [Logic/Threshold x](#).

7.4.18 Result if lower threshold is dropped below

This parameter is used to define the result of the function *Threshold* when the value received at the threshold input falls below the lower threshold.

The result can be linked with any output within the device or output on the Group Object *Status Result [Threshold]*.

Option	
<i>Unchanged</i>	The result of the function <i>Threshold</i> remains unchanged.
<i>1</i>	The result of the function <i>Threshold</i> is 1.
<i>0</i>	The result of the function <i>Threshold</i> is 0.

Prerequisites for visibility

- Parameter window *Configuration* \ Parameter *Enable Logic/Threshold x-y* \ Option Yes
- Parameter window *Logic/Threshold* \ Parameter window *Logic/Threshold x* \ Parameter *Function of the logic gate* \ Option *Threshold*
- The parameter is in the parameter window *Logic/Threshold* \ parameter window *Logic/Threshold x*.

7.4.19 Function of the logic gate

This parameter is used to define whether one of the logic functions or the threshold function is used.

Option	
<i>None</i>	The logic gate is not used.
AND	<p>The logic function <i>AND</i> is used. If the value 1 is present on all inputs, the result = 1.</p> <p>The following dependent parameters are shown:</p> <ul style="list-style-type: none"> • Value of Group Object "Connection A" after bus voltage recovery • Value of Group Object "Connection B" after bus voltage recovery • Read input Group Objects after bus voltage recovery and download • Invert result • Enable Group Object "Status Result" <p>The following dependent Group Objects are displayed:</p> <ul style="list-style-type: none"> • Connection A • Connection B
OR	<p>The logic function <i>OR</i> is used. If the value 1 is present on at least one input, the result = 1.</p> <p>The following dependent parameters are shown:</p> <ul style="list-style-type: none"> • Value of Group Object "Connection A" after bus voltage recovery • Value of Group Object "Connection B" after bus voltage recovery • Read input Group Objects after bus voltage recovery and download • Invert result • Enable Group Object "Status Result" <p>The following dependent Group Objects are displayed:</p> <ul style="list-style-type: none"> • Connection A • Connection B
<i>Exclusive OR</i>	<p>The logic function <i>exclusive OR</i> is used. If the value 1 is present on at least one input, the result = 1. If the same value is present on all inputs, the result = 0.</p> <p>The following dependent parameters are shown:</p> <ul style="list-style-type: none"> • Value of Group Object "Connection A" after bus voltage recovery • Value of Group Object "Connection B" after bus voltage recovery • Read input Group Objects after bus voltage recovery and download • Invert result • Enable Group Object "Status Result" <p>The following dependent Group Objects are displayed:</p> <ul style="list-style-type: none"> • Connection A • Connection B
GATE	<p>The logic function <i>GATE</i> is used. If the GATE is open (Connection A), the most recent value sent to the input (Connection B) remains as the result. If the GATE is blocked (Connection A), the value that the result had before the block is retained. After enabling, the result corresponds to the value of the input (Connection B).</p> <p>The following dependent parameters are shown:</p> <ul style="list-style-type: none"> • GATE blocks if Group Object "Connection A" equals • Value of Group Object "Connection A" after bus voltage recovery • Value of Group Object "Connection B" after bus voltage recovery • Read input Group Objects after bus voltage recovery and download • Invert result • Enable Group Object "Status Result" <p>The following dependent Group Objects are displayed:</p> <ul style="list-style-type: none"> • Connection A • Connection B
<i>Threshold</i>	<p>The function <i>Threshold</i> is used. More information: → Function Threshold, Page 43.</p> <p>The following dependent parameters are shown:</p> <ul style="list-style-type: none"> • Data point type of Group Object "Threshold input" • Upper threshold • Lower threshold • Change thresholds via Group Objects • Change thresholds via i-bus® Tool • Result if upper threshold is exceeded • Min. duration of the overshoot • Monitor range between thresholds • Result if lower threshold is dropped below • Min. duration of the undershoot • Read input Group Objects after bus voltage recovery and download • Enable Group Objects "Status Result" and "Status Input value between thresholds"
<i>1 bit Inverter</i>	<p>The logic function <i>1 bit Inverter</i> is used. If the value 1 is present at the input, the result = 0. If the value 0 is present at the input, the result = 1.</p> <p>The following dependent parameters are shown:</p> <ul style="list-style-type: none"> • Value of Group Object "Connection A" after bus voltage recovery • Read input Group Objects after bus voltage recovery and download • Enable Group Object "Status Result" <p>The following dependent Group Objects are displayed:</p> <ul style="list-style-type: none"> • Connection A

Prerequisites for visibility

- Parameter window [Configuration](#) \ Parameter [Enable Logic/Threshold x-y](#) \ Option Yes
- The parameter is in the parameter window [Logic/Threshold x](#).

7.4.20 Enable function Load shedding

This parameter enables the function *Load shedding* and the related parameter window [Load shedding](#) is displayed.

Option	
No	The function is not enabled.
Yes	The following dependent parameter windows are shown: <ul style="list-style-type: none"> • Load shedding

Prerequisites for visibility

- Parameter window [Configuration](#) \ Parameter [Enable output X](#) \ Option Yes
- The parameter is in the parameter window [Switch Actuator X](#) \ parameter window [Functions Switch Actuator](#).

7.4.21 Enable function Safety

This parameter enables the function *Safety* and the related parameter window [Safety](#) is displayed.

Option	
No	The function is not enabled.
Yes	The following dependent parameter windows are shown: <ul style="list-style-type: none"> • Safety

Prerequisites for visibility

- Parameter window [Configuration](#) \ Parameter [Enable output X](#) \ Option Yes
- The parameter is in the parameter window [Switch Actuator X](#) \ parameter window [Functions Switch Actuator](#).

7.4.22 Enable function Scenes [Switch Actuator]

This parameter enables the function *Scenes* and the related parameter window [Scene assignments \[Switch Actuator\]](#) is displayed.

Option	
No	The function is not enabled.
Yes	The following dependent parameter windows are shown: <ul style="list-style-type: none"> • Scene assignments [Switch Actuator] The following dependent Group Objects are displayed: <ul style="list-style-type: none"> • Scene 1...64

Prerequisites for visibility

- Parameter window [Configuration](#) \ Parameter [Enable output X](#) \ Option Yes
- The parameter is in the parameter window [Switch Actuator X](#) \ parameter window [Functions Switch Actuator](#).

7.4.23 Enable function Time

This parameter enables one of the following time functions and the related parameter window is displayed:

- *Staircase lighting*
- *Delay for switching on and off*
- *Flashing*

Option	
<i>No</i>	No time function is used for this output.
<i>Staircase lighting</i>	<p>The <i>Staircase lighting</i> time function is used for this output.</p> <p>The following dependent parameter windows are shown:</p> <ul style="list-style-type: none"> • Staircase lighting <p>The following dependent Group Objects are displayed:</p> <ul style="list-style-type: none"> • Staircase lighting permanent on
<i>Delay for switching on and off</i>	<p>The time function <i>Delay for switching on and off</i> is used for this output.</p> <p>The following dependent parameter windows are shown:</p> <ul style="list-style-type: none"> • Delay for switching on and off
<i>Flashing</i>	<p>The <i>Flashing</i> time function is used for this output.</p> <p>The following dependent parameter windows are shown:</p> <ul style="list-style-type: none"> • Flashing <p>The following dependent Group Objects are displayed:</p> <ul style="list-style-type: none"> • Flashing

Prerequisites for visibility

- Parameter window [Configuration](#) \ Parameter [Enable output X](#) \ Option [Yes](#)
- The parameter is in the parameter window [Switch Actuator X](#) \ parameter window [Functions Switch Actuator](#).

7.4.24 In period (0 = deactivated)

This parameter is used to define the period during which the device sends telegrams. The telegrams are sent as quickly as possible at the start of a period.

Note

The telegram rate limit is deactivated when the value 0 is selected.

More information: → [Telegram rate limit, Page 150](#).

Option
0 ... <u>1</u> ... 59 s

Prerequisites for visibility

- The parameter is in the parameter window [Configuration](#).

7.4.25 Enable Group Object "In operation"

This parameter enables the Group Object *In operation*.

Option	
<u>No</u>	The Group Object is not enabled.
<i>Yes, send value 0 cyclically</i>	<p>The Group Object is enabled and cyclically sends the value 0.</p> <p>The following dependent parameters are shown:</p> <ul style="list-style-type: none"> • Sending cycle <p>The following dependent Group Objects are displayed:</p> <ul style="list-style-type: none"> • In operation
<i>Yes, send value 1 cyclically</i>	<p>The Group Object is enabled and cyclically sends the value 1.</p> <p>The following dependent parameters are shown:</p> <ul style="list-style-type: none"> • Sending cycle <p>The following dependent Group Objects are displayed:</p> <ul style="list-style-type: none"> • In operation

Prerequisites for visibility

- The parameter is in the parameter window [Device settings](#).

7.4.26 Enable Group Object "Safety priority x"

These parameters are used to enable the Group Objects *Safety priority x* (x = 1, 2, 3).

More information: → [Safety priority, Page 41](#).

Option	
<u>No</u>	The Group Object is not enabled.
<i>Yes</i>	<p>The following dependent parameters are shown:</p> <ul style="list-style-type: none"> • Cyclical monitoring <p>The following dependent Group Objects are displayed:</p> <ul style="list-style-type: none"> • Safety priority x

Prerequisites for visibility

- The parameter is in the parameter window [Safety](#).

7.4.27 Enable Group Object "Status Result"

This parameter enables the Group Object *Status Result [Logic]*.

Option	
<u>No</u>	The Group Object is not enabled.
<i>Yes</i>	<p>The following dependent parameters are shown:</p> <ul style="list-style-type: none"> • Send value of Group Object "Status Result" <p>The following dependent Group Objects are displayed:</p> <ul style="list-style-type: none"> • Status Result [Logic]

Prerequisites for visibility

- Parameter window [Configuration](#) \ Parameter [Enable Logic/Threshold x-y](#) \ Option Yes
- Parameter window [Logic/Threshold](#) \ Parameter window [Logic/Threshold x](#) \ Parameter [Function of the logic gate](#) \ Options [AND](#) / [OR](#) / [Exclusive OR](#) / [GATE](#) / [1 bit Inverter](#)
- The parameter is in the parameter window [Logic/Threshold](#) \ parameter window [Logic/Threshold x](#).

7.4.28 Enable group object "Status Load shedding"

This parameter enables the Group Object *Status Load shedding*.

Option	
<i>No</i>	The Group Object is not enabled.
<i>Yes</i>	The following dependent parameters are shown: <ul style="list-style-type: none"> • <i>Send value of Group Object "Status Load shedding"</i> The following dependent Group Objects are displayed: <ul style="list-style-type: none"> • <i>Status Load shedding</i>

Prerequisites for visibility

- Parameter window *Configuration* \ Parameter *Enable output X* \ Option *Yes*
- Parameter window *Device settings* \ Parameter *Enable central Group Object "Receive load shedding stage"* \ Option *Yes*
- Parameter window *Switch Actuator X* \ Parameter window *Functions Switch Actuator* \ Parameter *Enable function Load shedding* \ Option *Yes*
- Parameter window *Switch Actuator X* \ Parameter window *Load shedding* \ Parameter *Parameter setting* \ Option *Individual*
- The parameter is in the parameter window *Switch Actuator X* \ parameter window *Load shedding*.

7.4.29 Enable Group Object "Request status values"

This parameter enables the Group Object *Request status values*.

All status messages of the device can be requested using the Group Object *Request status values* and sent on the bus (ABB i-bus® KNX).

Note

The values of the status Group Objects are sent only if sending on request is set in the related parameters.

Option	
<i>No</i>	The Group Object is not enabled.
<i>Yes</i>	The following dependent Group Objects are displayed: <ul style="list-style-type: none"> • <i>Request status values</i>

Prerequisites for visibility

- The parameter is in the parameter window *Device settings*.

7.4.30 Enable Group Objects "Status Result" and "Status Input value between thresholds"

This parameter enables the Group Objects *Status Result [Threshold]* and *Status Input value between thresholds*.

Option	
<i>No</i>	The Group Objects will not be enabled.
<i>Yes</i>	<p>The following dependent parameters are shown:</p> <ul style="list-style-type: none"> <i>Send value of Group Object "Status Result"</i> <p>The following dependent Group Objects are displayed:</p> <ul style="list-style-type: none"> <i>Status Result [Threshold]</i> <i>Status Input value between thresholds</i>

Prerequisites for visibility

- Parameter window *Configuration* \ Parameter *Enable Logic/Threshold x-y* \ Option *Yes*
- Parameter window *Logic/Threshold* \ Parameter window *Logic/Threshold x* \ Parameter *Function of the logic gate* \ Option *Threshold*
- The parameter is in the parameter window *Logic/Threshold* \ parameter window *Logic/Threshold x*.

7.4.31 Enable Group Objects "Status byte" [Switch Actuator]

This parameter enables one of the following Group Objects:

- Status byte all active priorities*
- Status byte highest active priority*

Option	
<i>No</i>	The Group Object is not enabled.
<i>Yes, all active priorities</i>	<p>The following dependent parameters are shown:</p> <ul style="list-style-type: none"> <i>Send value of Group Objects "Status byte" [Switch Actuator]</i> <p>The following dependent Group Objects are displayed:</p> <ul style="list-style-type: none"> <i>Status byte all active priorities</i>
<i>Yes, highest active priority</i>	<p>The following dependent parameters are shown:</p> <ul style="list-style-type: none"> <i>Send value of Group Objects "Status byte" [Switch Actuator]</i> <p>The following dependent Group Objects are displayed:</p> <ul style="list-style-type: none"> <i>Status byte highest active priority</i>

Prerequisites for visibility

- Parameter window *Configuration* \ Parameter *Enable output X* \ Option *Yes*
- Parameter window *Switch Actuator X* \ Parameter window *Basic settings [Switch Actuator]* \ Parameter *Parameter setting* \ Option *Individual*
- The parameter is in the parameter window *Switch Actuator X* \ parameter window *Basic settings [Switch Actuator]*.

7.4.32 Enable Time Group Objects for setting of device time

This parameter is used to define the data point type for the reception of the date and time. The corresponding Group Objects are enabled.

Option	
<i>No</i>	The Group Objects will not be enabled.
<i>Date (DPT 11.001)/time (10.001)</i>	<p>Date and time are sent via two separate Group Objects on the bus (ABB i-bus® KNX).</p> <p>The following dependent parameters are shown:</p> <ul style="list-style-type: none"> • Request Date/Time via Group Object <p>The following dependent Group Objects are displayed:</p> <ul style="list-style-type: none"> • Set date • Set time • Request Date/Time
<i>Date/Time (DPT 19.001)</i>	<p>Date and time are sent via a Group Object on the bus (ABB i-bus® KNX).</p> <p>The following dependent parameters are shown:</p> <ul style="list-style-type: none"> • Request Date/Time via Group Object <p>The following dependent Group Objects are displayed:</p> <ul style="list-style-type: none"> • Set date/time • Request Date/Time

Prerequisites for visibility

- The parameter is in the parameter window [Device settings](#).

7.4.33 Load shedding stage

This parameter is used to assign the channel to a load shedding stage.

Option	
<i>1... 15</i>	

Prerequisites for visibility

- Parameter window [Configuration](#) \ Parameter [Enable output X](#) \ Option *Yes*
- Parameter window [Device settings](#) \ Parameter [Enable central Group Object "Receive load shedding stage"](#) \ Option *Yes*
- Parameter window [Switch Actuator X](#) \ Parameter window [Functions Switch Actuator](#) \ Parameter [Enable function Load shedding](#) \ Option *Yes*
- Parameter window [Switch Actuator X](#) \ Parameter window [Load shedding](#) \ Parameter [Parameter setting](#) \ Option *Individual*
- The parameter is in the parameter window [Switch Actuator X](#) \ parameter window [Load shedding](#).

7.4.34 Overwrite load shedding stage at download

This parameter is used to define whether the load shedding stage assigned to the channel is overwritten while downloading the application to the device.

Option	
<i>No</i>	The existing values in the device are not overwritten.
<i>Yes</i>	The existing values in the device are overwritten with the values defined in ETS.

Prerequisites for visibility

- Parameter window [Configuration](#) \ Parameter [Enable output X](#) \ Option *Yes*
- Parameter window [Device settings](#) \ Parameter [Enable central Group Object "Receive load shedding stage"](#) \ Option *Yes*
- Parameter window [Switch Actuator X](#) \ Parameter window [Functions Switch Actuator](#) \ Parameter [Enable function Load shedding](#) \ Option *Yes*
- Parameter window [Switch Actuator X](#) \ Parameter window [Load shedding](#)
 - Parameter [Parameter setting](#) \ Option *Individual*
 - Parameter [Change load shedding stage via Group Object](#) \ Option *Yes*
- or
- Parameter [Change load shedding stage via i-bus® Tool](#) \ Option *Yes*
- The parameter is in the parameter window [Switch Actuator X](#) \ parameter window [Load shedding](#).

7.4.35 Change load shedding stage via i-bus® Tool

This parameter is used to define whether the load shedding stage assigned to the channel can be changed via i-bus® Tool.

Note

The interface to i-bus® Tool is available from the following software versions:

- Application from V1.2
- Firmware from V0.2.0

Option	
<i>No</i>	The load shedding stage cannot be changed via i-bus® Tool.
<i>Yes</i>	The following dependent parameters are shown: <ul style="list-style-type: none"> • Overwrite load shedding stage at download

Prerequisites for visibility

- Parameter window [Configuration](#) \ Parameter [Enable output X](#) \ Option *Yes*
- Parameter window [Device settings](#) \ Parameter [Enable central Group Object "Receive load shedding stage"](#) \ Option *Yes*
- Parameter window [Switch Actuator X](#) \ Parameter window [Functions Switch Actuator](#) \ Parameter [Enable function Load shedding](#) \ Option *Yes*
- Parameter window [Switch Actuator X](#) \ Parameter window [Load shedding](#) \ Parameter [Parameter setting](#) \ Option *Individual*
- The parameter is in the parameter window [Switch Actuator X](#) \ parameter window [Load shedding](#).

7.4.36 Change load shedding stage via Group Object

This parameter is used to define whether the load shedding stage assigned to the channel can be changed via the Group Object [Set load shedding stage](#).

Option	
<i>No</i>	The load shedding stage cannot be changed via a Group Object.
<i>Yes</i>	The following dependent parameters are shown: <ul style="list-style-type: none"> • Overwrite load shedding stage at download The following dependent Group Objects are displayed: <ul style="list-style-type: none"> • Set load shedding stage

Prerequisites for visibility

- Parameter window [Configuration](#) \ Parameter [Enable output X](#) \ Option *Yes*
- Parameter window [Device settings](#) \ Parameter [Enable central Group Object "Receive load shedding stage"](#) \ Option *Yes*
- Parameter window [Switch Actuator X](#) \ Parameter window [Functions Switch Actuator](#) \ Parameter [Enable function Load shedding](#) \ Option *Yes*
- Parameter window [Switch Actuator X](#) \ Parameter window [Load shedding](#) \ Parameter [Parameter setting](#) \ Option *Individual*
- The parameter is in the parameter window [Switch Actuator X](#) \ parameter window [Load shedding](#).

7.4.37 Enable Logic/Threshold x-y

This parameter enables the functions *Logic* and *Threshold* in groups of four.

The functions *Logic* and *Threshold* are configured in the parameter window [Logic/Threshold x](#).

The functions *Logic* and *Threshold* can be used independently or linked with an output.

More information → [Function Logic, Page 42](#), → [Function Threshold, Page 43](#).

Note

The default value is dependent on the product variant and does not apply to all logic and threshold groups.

Option	
<i>No</i>	The functions <i>Logic</i> and <i>Threshold</i> are not enabled.
<i>Yes</i>	The following dependent parameter windows are shown: <ul style="list-style-type: none"> • Logic/Threshold • Logic/Threshold x

Prerequisites for visibility

- The parameter is in the parameter window [Configuration](#).

7.4.38 Maximum number of sent telegrams

This parameter is used to define the number of telegrams sent within a period that can be set.

The period is defined in the parameter → [In period \(0 = deactivated\), Page 93](#).

More information: → [Telegram rate limit, Page 150.](#)

Option

3... 20... 100

Prerequisites for visibility

- The parameter is in the parameter window [Configuration](#).

7.4.39 Min. duration of the overshoot

This parameter is used to define how long the value received at the threshold input must exceed the threshold before the result of the function *Threshold* is updated.

Option

00:00:00... 18:12:15 hh:mm:ss

Prerequisites for visibility

- Parameter window [Configuration](#) \ Parameter [Enable Logic/Threshold x-y](#) \ Option Yes
- Parameter window [Logic/Threshold](#) \ Parameter window [Logic/Threshold x](#) \ Parameter [Function of the logic gate](#) \ Option [Threshold](#)
- The parameter is in the parameter window [Logic/Threshold](#) \ parameter window [Logic/Threshold x](#).

7.4.40 Min. duration of the undershoot

This parameter is used to define how long the value received at the threshold input must undershoot the threshold before the result of the function *Threshold* is updated.

Option

00:00:00... 18:12:15 hh:mm:ss

Prerequisites for visibility

- Parameter window [Configuration](#) \ Parameter [Enable Logic/Threshold x-y](#) \ Option Yes
- Parameter window [Logic/Threshold](#) \ Parameter window [Logic/Threshold x](#) \ Parameter [Function of the logic gate](#) \ Option [Threshold](#)
- The parameter is in the parameter window [Logic/Threshold](#) \ parameter window [Logic/Threshold x](#).

7.4.41 Minimum dwell time between the thresholds

This parameter is used to define how long the value received at the threshold input must be between the thresholds before an evaluation occurs.

Option

00:00:00... 18:12:15 hh:mm:ss

Prerequisites for visibility

- Parameter window [Configuration](#) \ Parameter [Enable Logic/Threshold x-y](#) \ Option Yes
- Parameter window [Logic/Threshold](#) \ Parameter window [Logic/Threshold x](#)
 - Parameter [Function of the logic gate](#) \ Option [Threshold](#)
 - Parameter [Monitor range between thresholds](#) \ Option Yes
- The parameter is in the parameter window [Logic/Threshold](#) \ parameter window [Logic/Threshold x](#).

7.4.42 Upper threshold

This parameter is used to define the upper threshold. Default values and units depend on the option selected in the *Data point type of Group Object "Threshold input"* parameter.

Option	
0 ... 50 ... 100 %	Upper threshold on selection of DPT 5.001.
0 ... 200 ... 255	Upper threshold on selection of DPT 5.010.
0 ... 40000 ... 65535	Upper threshold on selection of DPT 7.001.
-100 ... 22 ... 250 °C	Upper threshold on selection of DPT 9.001.
0 ... 400 ... 100,000 lux	Upper threshold on selection of DPT 9.004.
0 ... 16000 ... 240000 mA	Upper threshold on selection of DPT 9.021.
0 ... 16 ... 24 A	Upper threshold on selection of DPT 14.019.
0 ... 4000 ... 10000 W	Upper threshold on selection of DPT 14.056.
0 ... 3 ... 10 kW	Upper threshold on selection of DPT 9.024.
0 ... 100000 ... 2147483647 Wh	Upper threshold on selection of DPT 13.010.
0 ... 70 ... 2147483647 kWh	Upper threshold on selection of DPT 13.013.

Prerequisites for visibility

- Parameter window *Configuration* \ Parameter *Enable Logic/Threshold x-y* \ Option *Yes*
- Parameter window *Logic/Threshold* \ Parameter window *Logic/Threshold x* \ Parameter *Function of the logic gate* \ Option *Threshold*
- The parameter is in the parameter window *Logic/Threshold* \ parameter window *Logic/Threshold x*.

7.4.43 Parameter setting

This parameter is used to define whether the settings for the parameter window are adopted from the template or each parameter is set individually.

Option	
<i>Apply from template</i>	The settings for the parameters are adopted from the template.
<i>Individual</i>	The parameters can be set individually.

Prerequisites for visibility

- The parameter appears at various points in the application. The visibility is dependent on the application and the higher-level parameter.

7.4.44 Feedback of contact position via Group Object "Status Switch"

This parameter is used to define whether the position of the relay contact is signaled via the Group Object *Status Switch*.

Option	
<i>No</i>	The position of the relay contact is not signaled.
<i>Yes</i>	The following dependent parameters are shown: <ul style="list-style-type: none"> • <i>Value of Group Object "Status Switch"</i> • <i>Send value of Group Object "Status Switch"</i> The following dependent Group Objects are displayed: <ul style="list-style-type: none"> • <i>Status Switch</i>

Prerequisites for visibility

- Parameter window *Configuration* \ Parameter *Enable output X* \ Option *Yes*
- Parameter window *Switch Actuator X* \ Parameter window *Basic settings [Switch Actuator]* \ Parameter *Parameter setting* \ Option *Individual*
- The parameter is in the parameter window *Switch Actuator X* \ parameter window *Basic settings [Switch Actuator]*.

7.4.45 Switch output reacts to central Switch Group Object

This parameter can be used to define whether the output can be switched via the central Group Object [Switch](#).

Option
<i>No</i>
<i>Yes</i>

Prerequisites for visibility

- Parameter window [Configuration](#) \ Parameter [Enable output X](#) \ Option *Yes*
- Parameter window [Switch Actuator X](#) \ Parameter window [Device settings](#) \ Parameter [Enable central Group Object "Switch"](#) \ Option *Yes*
- Parameter window [Switch Actuator X](#) \ Parameter window [Basic settings \[Switch Actuator\]](#) \ Parameter [Parameter setting](#) \ Option *Individual*
- The parameter is in the parameter window [Switch Actuator X](#) \ parameter window [Basic settings \[Switch Actuator\]](#).

7.4.46 Switching reaction on active load shedding stage

This parameter is used to define the position of the relay contact if a load shedding stage is activated.

Note

Whether the relay contact is opened or closed depends on the setting in the parameter [Reaction of output](#).

Option	
<i>Off</i>	Parameterization as normally closed contact: The relay contact is closed. Parameterization as normally open contact: The relay contact is opened.
<i>On</i>	Parameterization as normally closed contact: The relay contact is opened. Parameterization as normally open contact: The relay contact is closed.

Prerequisites for visibility

- Parameter window [Configuration](#) \ Parameter [Enable output X](#) \ Option *Yes*
- Parameter window [Device settings](#) \ Parameter [Enable central Group Object "Receive load shedding stage"](#) \ Option *Yes*
- Parameter window [Switch Actuator X](#) \ Parameter window [Functions Switch Actuator](#) \ Parameter [Enable function Load shedding](#) \ Option *Yes*
- Parameter window [Switch Actuator X](#) \ Parameter window [Load shedding](#) \ Parameter [Parameter setting](#) \ Option *Individual*
- The parameter is in the parameter window [Switch Actuator X](#) \ parameter window [Load shedding](#).

7.4.47 Switching reaction on bus voltage failure

This parameter is used to define the reaction of the relay contact on bus voltage failure.

i Note

The safety functions have priority over all other functions and priorities.
More information: → [Priorities, Page 147](#).

Option

<i>Contact unchanged</i>	The position of the relay contact remains unchanged.
<i>Contact open</i>	The relay contact is open if no safety function is active.
<i>Contact closed</i>	The relay contact is closed if no safety function is active.

Prerequisites for visibility

- Parameter window [Configuration](#) \ Parameter [Enable output X](#) \ Option *Yes*
- Parameter window [Switch Actuator X](#) \ Parameter window [Basic settings \[Switch Actuator\]](#) \ Parameter [Parameter setting](#) \ Option *Individual*
- The parameter is in the parameter window [Switch Actuator X](#) \ parameter window [Basic settings \[Switch Actuator\]](#).

7.4.48 Switching reaction on revoke of load shedding stage

This parameter is used to define the position of the relay contact if a load shedding stage is revoked.

i Note

Whether the relay contact is opened or closed depends on the setting in the parameter [Reaction of output](#).

Option

<i>No reaction</i>	The position of the relay contact remains unchanged.
<i>On</i>	Parameterization as normally closed contact: The relay contact is opened. Parameterization as normally open contact: The relay contact is closed.
<i>Off</i>	Parameterization as normally closed contact: The relay contact is closed. Parameterization as normally open contact: The relay contact is opened.
<i>Refreshed KNX state</i>	The refreshed KNX state is used. → Refreshed KNX state, Page 150

Prerequisites for visibility

- Parameter window [Configuration](#) \ Parameter [Enable output X](#) \ Option *Yes*
- Parameter window [Device settings](#) \ Parameter [Enable central Group Object "Receive load shedding stage"](#) \ Option *Yes*
- Parameter window [Switch Actuator X](#) \ Parameter window [Functions Switch Actuator](#) \ Parameter [Enable function Load shedding](#) \ Option *Yes*
- Parameter window [Switch Actuator X](#) \ Parameter window [Load shedding](#) \ Parameter [Parameter setting](#) \ Option *Individual*
- The parameter is in the parameter window [Switch Actuator X](#) \ parameter window [Load shedding](#).

7.4.49 Switching reaction on cancellation of block, forced operation and safety priority

This parameter is used to define the relay contact position after cancellation of safety functions (safety priorities, block or forced operation).

Note

Whether the relay contact is opened or closed depends on the setting in the parameter [Reaction of output](#).

Option	
<i>No reaction</i>	The position of the relay contact remains unchanged.
<i>On</i>	Parameterization as normally closed contact: The relay contact is opened. Parameterization as normally open contact: The relay contact is closed.
<i>Off</i>	Parameterization as normally closed contact: The relay contact is closed. Parameterization as normally open contact: The relay contact is opened.
<i>Refreshed KNX state</i>	The refreshed KNX state is used. → Refreshed KNX state, Page 150

Prerequisites for visibility

- Parameter window [Configuration](#) \ Parameter [Enable output X](#) \ Option *Yes*
- Parameter window [Switch Actuator X](#) \ Parameter window [Functions Switch Actuator](#) \ Parameter [Enable function Safety](#) \ Option *Yes*
- Parameter window [Switch Actuator X](#) \ Parameter window [Safety](#) \ Parameter [Parameter setting](#) \ Option *Individual*
- The parameter is in the parameter window [Switch Actuator X](#) \ parameter window [Safety](#).

7.4.50 Switching reaction on safety priority x

This parameter is used to define the position of the relay contact for a safety priority. The relay contact is switched to the defined position and blocked.

Note

Whether the relay contact is opened or closed depends on the setting in the parameter [Reaction of output](#).

More information: → [Safety priority, Page 41](#).

Note

If a safety priority is active, the operation of the output via Group Objects and i-bus® Tool is blocked. Higher-priority safety functions continue to run → [Function diagram Switch Actuator, Page 40](#).

Option	
<i>No reaction/deactivated</i>	The position of the relay contact remains unchanged. The output does not react to the safety priority.
<i>On</i>	Parameterization as normally closed contact: The relay contact is opened. Parameterization as normally open contact: The relay contact is closed.
<i>Off</i>	Parameterization as normally closed contact: The relay contact is closed. Parameterization as normally open contact: The relay contact is opened.
<i>Unchanged (block)</i>	The relay contact is blocked in the current position.

Prerequisites for visibility

- Parameter window [Configuration](#) \ Parameter [Enable output X](#) \ Option *Yes*
- Parameter window [Safety](#) \ Parameter [Enable Group Object "Safety priority x"](#) \ Option *Yes*
- Parameter window [Switch Actuator X](#) \ Parameter window [Functions Switch Actuator](#) \ Parameter [Enable function Safety](#) \ Option *Yes*
- Parameter window [Safety](#) \ Parameter [Parameter setting](#) \ Option *Individual*
- The parameter is in the parameter window [Switch Actuator X](#) \ parameter window [Safety](#).

7.4.51 Switching reaction on block

This parameter is used to define the position of the relay contact if blocked. The relay contact is switched to the defined position and blocked.

i Note

Whether the relay contact is opened or closed depends on the setting in the parameter *Reaction of output*.

More information: → [Block, Page 41](#).

i Note

If the safety function is active, the operation of the output via Group Objects and i-bus® Tool is blocked.

Higher-priority safety functions continue to run → [Function diagram Switch Actuator, Page 40](#).

Option	
<i>No reaction/deactivated</i>	The function <i>Block</i> is deactivated.
<i>On</i>	Parameterization as normally closed contact: The relay contact is opened. Parameterization as normally open contact: The relay contact is closed. The following dependent Group Objects are displayed: <ul style="list-style-type: none"> • Block
<i>Off</i>	Parameterization as normally closed contact: The relay contact is closed. Parameterization as normally open contact: The relay contact is opened. The following dependent Group Objects are displayed: <ul style="list-style-type: none"> • Block
<i>Unchanged (block)</i>	The relay contact is blocked in the current position. The following dependent Group Objects are displayed: <ul style="list-style-type: none"> • Block

Prerequisites for visibility

- Parameter window [Configuration](#) \ Parameter [Enable output X](#) \ Option *Yes*
- Parameter window [Switch Actuator X](#) \ Parameter window [Functions Switch Actuator](#) \ Parameter [Enable function Safety](#) \ Option *Yes*
- Parameter window [Switch Actuator X](#) \ Parameter window [Safety](#) \ Parameter [Parameter setting](#) \ Option *Individual*
- The parameter is in the parameter window [Switch Actuator X](#) \ parameter window [Safety](#).

7.4.52 Switching reaction on forced operation

This parameter is used to define the position of the relay contact during forced operation. The relay contact is switched to the defined position and blocked.

i Note

Whether the relay contact is opened or closed depends on the setting in the parameter *Reaction of output*.

More information: → [forced operation, Page 42](#).

i Note

If the safety function is active, the operation of the output via Group Objects and i-bus® Tool is blocked.

Higher-priority safety functions continue to run → [Function diagram Switch Actuator, Page 40](#).

Option	
<i>On</i>	Parameterization as normally closed contact: The relay contact is opened. Parameterization as normally open contact: The relay contact is closed.
<i>Off</i>	Parameterization as normally closed contact: The relay contact is closed. Parameterization as normally open contact: The relay contact is opened.
<i>Unchanged (block)</i>	The relay contact is blocked in the current position.

Prerequisites for visibility

- Parameter window *Configuration* \ Parameter *Enable output X* \ Option *Yes*
- Parameter window *Switch Actuator X* \ Parameter window *Functions Switch Actuator* \ Parameter *Enable function Safety* \ Option *Yes*
- Parameter window *Switch Actuator X* \ Parameter window *Safety*
 - Parameter *Parameter setting* \ Option *Individual*
 - Parameter *Forced operation (1 bit / 2 bit) [Switch Actuator]* \ Options *Activated 1 bit – 0 active / Activated 1 bit – 1 active*
- The parameter is in the parameter window *Switch Actuator X* \ parameter window *Safety*.

7.4.53 Overwrite thresholds on download

This parameter is used to define whether the thresholds are overwritten while downloading the application to the device.

Option	
<i>No</i>	The existing values in the device are not overwritten.
<i>Yes</i>	The existing values in the device are overwritten with the values defined in ETS.

Prerequisites for visibility

- Parameter window *Configuration* \ Parameter *Enable Logic/Threshold x-y* \ Option *Yes*
- Parameter window *Logic/Threshold* \ Parameter window *Logic/Threshold x*
 - Parameter *Function of the logic gate* \ Option *Threshold*
 - Parameter *Change thresholds via Group Objects* \ Option *Yes*
 - or
 - Parameter *Change thresholds via i-bus® Tool* \ Option *Yes*
- The parameter is in the parameter window *Logic/Threshold* \ parameter window *Logic/Threshold x*.

7.4.54 Change thresholds via i-bus® Tool

This parameter is used to define whether thresholds set in ETS can be changed via i-bus® Tool.

i Note

The interface to i-bus® Tool is available from the following software versions:

- Application from V1.2
- Firmware from V0.2.0

Option

Prerequisites for visibility

- Parameter window *Configuration* \ Parameter *Enable Logic/Threshold x-y* \ Option *Yes*
- Parameter window *Logic/Threshold* \ Parameter window *Logic/Threshold x* \ Parameter *Function of the logic gate* \ Option *Threshold*
- The parameter is in the parameter window *Logic/Threshold* \ parameter window *Logic/Threshold x*.

7.4.55 Change thresholds via Group Objects

This parameter is used to define whether the thresholds set in ETS can be changed via the corresponding Group Objects.

Option

<i>No</i>	The values cannot be changed via Group Objects.
<i>Yes</i>	<p>The values can be changed via Group Objects. Depending on the setting in the parameter <i>Data point type of Group Object "Threshold input"</i>, the following Group Objects are displayed:</p> <ul style="list-style-type: none"> • <i>Change upper threshold</i> (DPT 13.010) <i>Change lower threshold</i> (DPT 13.010) • <i>Change upper threshold</i> (DPT 13.013) <i>Change lower threshold</i> (DPT 13.013) • <i>Change upper threshold</i> (DPT 14.019) <i>Change lower threshold</i> (DPT 14.019) • <i>Change upper threshold</i> (DPT 14.056) <i>Change upper threshold</i> (DPT 14.056) • <i>Change upper threshold</i> (DPT 5.001) <i>Change lower threshold</i> (DPT 5.001) • <i>Change upper threshold</i> (DPT 5.010) <i>Change lower threshold</i> (DPT 5.010) • <i>Change upper threshold</i> (DPT 7.001) <i>Change lower threshold</i> (DPT 7.001) • <i>Change upper threshold</i> (DPT 9.001) <i>Change lower threshold</i> (DPT 9.001) • <i>Change upper threshold</i> (DPT 9.004) <i>Change lower threshold</i> (DPT 9.004) • <i>Change upper threshold</i> (DPT 9.021) <i>Change lower threshold</i> (DPT 9.021) • <i>Change upper threshold</i> (DPT 9.024) <i>Change lower threshold</i> (DPT 9.024) <p>The following dependent parameters are shown:</p> <ul style="list-style-type: none"> • <i>Overwrite thresholds on download</i>

Prerequisites for visibility

- Parameter window *Configuration* \ Parameter *Enable Logic/Threshold x-y* \ Option *Yes*
- Parameter window *Logic/Threshold* \ Parameter window *Logic/Threshold x* \ Parameter *Function of the logic gate* \ Option *Threshold*
- The parameter is in the parameter window *Logic/Threshold* \ parameter window *Logic/Threshold x*.

7.4.56 Sending and switching delay after bus voltage recovery

This parameter is used to define the sending and switching delay after bus voltage recovery.

More information: → [Sending and switching delay, Page 150](#).

i Note

The device draws energy for switching the outputs via the bus (ABB i-bus® KNX). After application of the bus voltage and after bus voltage recovery, it takes about 10 ... 30 seconds before sufficient energy is available to switch all relays simultaneously.

The first relay is not switched until the device has stored sufficient energy to place all outputs in a defined contact position if there is a bus voltage failure.

i Note

After bus voltage recovery, the device waits for the sending delay time to elapse before sending telegrams on the bus.

Option

00:00:02 ... 00:04:15 hh:mm:ss

Prerequisites for visibility

- The parameter is in the parameter window [Device settings](#).

7.4.57 Sending cycle

This parameter is used to define the cycle in which the Group Object *In operation* sends a telegram.

Option

00:00:01 ... 00:10:00 ... 18:12:15 hh:mm:ss

Prerequisites for visibility

- Parameter window [Device settings](#) \ Parameter [Enable Group Object "In operation"](#) \ Options Yes, send value 0 cyclically / Yes, send value 1 cyclically
- The parameter is in the parameter window [Device settings](#).

7.4.58 Read safety Group Objects after bus voltage recovery and download

This parameter is used to define whether the following safety Group Objects are read after bus voltage recovery or download:

- [Safety priority x](#)

i Note

To update the Group Objects after bus voltage recovery and download, the read flags must be set for the corresponding Group Objects of the sending device.

Option

No The safety Group Objects are not read after bus voltage recovery and download.

Yes The safety Group Objects send a Value Read to the sending Group Objects after bus voltage recovery and download. If there are alarms present, the parameterized results are run. → [Value Read, Page 151](#)

Prerequisites for visibility

- The parameter is in the parameter window [Safety](#).

7.4.59 Overwrite Scenes on download

This parameter is used to define whether the Scenes saved in the device are overwritten during a download.

Option
No
Yes

Prerequisites for visibility

- Parameter window [Configuration](#) \ Parameter [Enable output X](#) \ Option Yes
- Parameter window [Switch Actuator X](#) \ Parameter window [Functions Switch Actuator](#) \ Parameter [Enable function Scenes \[Switch Actuator\]](#) \ Option Yes
- Parameter window [Switch Actuator X](#) \ Parameter window [Scene assignments \[Switch Actuator\]](#) \ Parameter [Parameter setting](#) \ Option *Individual*
- The parameter is in the parameter window [Switch Actuator X](#) \ parameter window [Scene assignments \[Switch Actuator\]](#).

7.4.60 Scene number

This parameter is used to define the Scene number (1 ... 64).

Option
1... 64

Prerequisites for visibility

- Parameter window [Configuration](#) \ Parameter [Enable output X](#) \ Option Yes
- Parameter window [Switch Actuator X](#) \ Parameter window [Functions Switch Actuator](#) \ Parameter [Enable function Scenes \[Switch Actuator\]](#) \ Option Yes
- Parameter window [Switch Actuator X](#) \ Parameter window [Scene assignments \[Switch Actuator\]](#)
 - Parameter [Parameter setting](#) \ Option *Individual*
 - Parameter [Enable Scene assignment x \[Switch Actuator\]](#) \ Option Yes
- The parameter is in the parameter window [Switch Actuator X](#) \ parameter window [Scene assignments \[Switch Actuator\]](#).

7.4.61 Enable Scene assignment x [Switch Actuator]

This parameter is used to create and enable the Scene assignment x (x = 1 ... 16) and assign the output.

Option	
No	Scene assignment x is not used.
Yes	The following dependent parameters are shown: <ul style="list-style-type: none"> • Recall Scene x also via 1-bit Group Object • Scene number • Delay • Reaction on Scene recall

Prerequisites for visibility

- Parameter window [Configuration](#) \ Parameter [Enable output X](#) \ Option Yes
- Parameter window [Switch Actuator X](#) \ Parameter window [Functions Switch Actuator](#) \ Parameter [Enable function Scenes \[Switch Actuator\]](#) \ Option Yes
- Parameter window [Switch Actuator X](#) \ Parameter window [Scene assignments \[Switch Actuator\]](#) \ Parameter [Parameter setting](#) \ Option *Individual*
- The parameter is in the parameter window [Switch Actuator X](#) \ parameter window [Scene assignments \[Switch Actuator\]](#).

7.4.62 GATE blocks if Group Object "Connection A" equals

This parameter is used to define the telegram value on the Group Object *Connection A* for which the GATE is blocked. If the GATE is blocked, telegrams received on the Group Object *Connection B* are ignored.

Option
<u>1</u>
0

Prerequisites for visibility

- Parameter window *Configuration* \ Parameter *Enable Logic/Threshold x-y* \ Option Yes
- Parameter window *Logic/Threshold* \ Parameter window *Logic/Threshold x* \ Parameter *Function of the logic gate* \ Option *GATE*
- The parameter is in the parameter window *Logic/Threshold* \ parameter window *Logic/Threshold x*.

7.4.63 Block staircase lighting after bus voltage recovery

This parameter is used to define whether the function *Staircase lighting* is blocked after bus voltage recovery.

Option
<u>No</u>
Yes

Prerequisites for visibility

- Parameter window *Configuration* \ Parameter *Enable output X* \ Option Yes
- Parameter window *Switch Actuator X* \ Parameter window *Functions Switch Actuator* \ Parameter *Enable function Time* \ Option *Staircase lighting*
- Parameter window *Switch Actuator X* \ Parameter window *Staircase lighting*
 - Parameter *Parameter setting* \ Option *Individual*
 - Parameter *Block staircase lighting via Group Object* \ Option Yes
- The parameter is in the parameter window *Switch Actuator X* \ parameter window *Staircase lighting*.

7.4.64 Switching reaction of staircase lighting on telegram value 0/1

This parameter is used to define the telegram value with which the output is switched on and prematurely switched off.

Note

If the function *Permanent on* is active, the function *Staircase lighting* cannot be switched off prematurely

Option	
<u>On with "1" and off with "0"</u>	The output is switched on with the telegram value 1 and off with the telegram value 0.
On with "1" and no action for "0"	The output is switched on with the telegram value 1. Premature switch-off is not possible.
On with "1" or with "0", no switch off	The output is switched on independently of the telegram value. Premature switch-off is not possible.

Prerequisites for visibility

- Parameter window *Configuration* \ Parameter *Enable output X* \ Option Yes
- Parameter window *Switch Actuator X* \ Parameter window *Functions Switch Actuator* \ Parameter *Enable function Time* \ Option *Staircase lighting*
- Parameter window *Switch Actuator X* \ Parameter window *Staircase lighting* \ Parameter *Parameter setting* \ Option *Individual*
- The parameter is in the parameter window *Switch Actuator X* \ parameter window *Staircase lighting*.

7.4.65 Block staircase lighting via Group Object

This parameter is used to define whether the function *Staircase lighting* can be blocked via Group Object. If the function *Staircase lighting* is blocked, the switch-on command is forwarded without time function in the function chain. The output reacts according to its parameterization.

Option	
<i>No</i>	The function <i>Staircase lighting</i> cannot be blocked via a Group Object.
<i>Yes</i>	The following dependent parameters are shown: <ul style="list-style-type: none"> Block staircase lighting after bus voltage recovery The following dependent Group Objects are displayed: <ul style="list-style-type: none"> Block staircase lighting

Prerequisites for visibility

- Parameter window [Configuration](#) \ Parameter [Enable output X](#) \ Option *Yes*
- Parameter window [Switch Actuator X](#) \ Parameter window [Functions Switch Actuator](#) \ Parameter [Enable function Time](#) \ Option *Staircase lighting*
- Parameter window [Switch Actuator X](#) \ Parameter window [Staircase lighting](#) \ Parameter [Parameter setting](#) \ Option *Individual*
- The parameter is in the parameter window [Switch Actuator X](#) \ parameter window [Staircase lighting](#).

7.4.66 Staircase lighting time

This parameter is used to define how long the output remains switched on after an On telegram.

Option	
<i>00:00:00 ... 00:05:00 ... 18:12:15 hh:mm:ss</i>	

Prerequisites for visibility

- Parameter window [Configuration](#) \ Parameter [Enable output X](#) \ Option *Yes*
- Parameter window [Switch Actuator X](#) \ Parameter window [Functions Switch Actuator](#) \ Parameter [Enable function Time](#) \ Option *Staircase lighting*
- Parameter window [Switch Actuator X](#) \ Parameter window [Staircase lighting](#) \ Parameter [Parameter setting](#) \ Option *Individual*
- The parameter is in the parameter window [Switch Actuator X](#) \ parameter window [Staircase lighting](#).

7.4.67 Overwrite staircase lighting time on download

This parameter is used to define whether the staircase lighting time is overwritten while downloading the application to the device.

Option	
<i>No</i>	The existing values in the device are not overwritten.
<i>Yes</i>	The existing values in the device are overwritten with the values defined in ETS.

Prerequisites for visibility

- Parameter window [Configuration](#) \ Parameter [Enable output X](#) \ Option *Yes*
- Parameter window [Switch Actuator X](#) \ Parameter window [Functions Switch Actuator](#) \ Parameter [Enable function Time](#) \ Option *Staircase lighting*
- Parameter window [Switch Actuator X](#) \ Parameter window [Staircase lighting](#)
 - Parameter [Parameter setting](#) \ Option *Individual*
 - Parameter [Change staircase lighting time via Group Object](#) \ Option *Yes*
 or
 - Parameter [Change staircase lighting time via i-bus® Tool](#) \ Option *Yes*
- The parameter is in the parameter window [Switch Actuator X](#) \ parameter window [Staircase lighting](#).

7.4.68 Restart staircase lighting time after permanent on

This parameter is used to define how the staircase lighting time reacts after the function *Permanent on* is restarted.

Option	
<i>No</i>	The output is switched off after the function <i>Permanent on</i> is ended.
<i>Yes</i>	The staircase lighting time is restarted and the output remains switched on after the function <i>Permanent on</i> is ended.

Prerequisites for visibility

- Parameter window [Configuration](#) \ Parameter [Enable output X](#) \ Option *Yes*
- Parameter window [Switch Actuator X](#) \ Parameter window [Functions Switch Actuator](#) \ Parameter [Enable function Time](#) \ Option *Staircase lighting*
- Parameter window [Switch Actuator X](#) \ Parameter window [Staircase lighting](#) \ Parameter [Parameter setting](#) \ Option *Individual*
- The parameter is in the parameter window [Switch Actuator X](#) \ parameter window [Staircase lighting](#).

7.4.69 Staircase lighting time can be started again

This parameter is used to define whether the staircase lighting time is extended by further On telegrams.

Option	
<i>No</i>	Further On telegrams will be ignored. The staircase lighting time will not be extended.
<i>Yes</i>	The staircase lighting time will be extended by additional On telegrams. The number of extensions can be set in the parameter Staircase lighting time extendable (pumping) . More information: → Function Staircase lighting, Page 52 . The following dependent parameters are shown: <ul style="list-style-type: none"> • Staircase lighting time extendable (pumping)

Prerequisites for visibility

- Parameter window [Configuration](#) \ Parameter [Enable output X](#) \ Option *Yes*
- Parameter window [Switch Actuator X](#) \ Parameter window [Functions Switch Actuator](#) \ Parameter [Enable function Time](#) \ Option *Staircase lighting*
- Parameter window [Switch Actuator X](#) \ Parameter window [Staircase lighting](#) \ Parameter [Parameter setting](#) \ Option *Individual*
- The parameter is in the parameter window [Switch Actuator X](#) \ parameter window [Staircase lighting](#).

7.4.70 Change staircase lighting time via i-bus® Tool

This parameter is used to define whether the staircase lighting time set in ETS can be changed via i-bus® Tool.

i Note

The interface to i-bus® Tool is available from the following software versions:

- Application from V1.2
- Firmware from V0.2.0

Option

<i>No</i>	The staircase lighting time can be defined only in ETS.
<i>Yes</i>	The following dependent parameters are shown: <ul style="list-style-type: none"> • Overwrite staircase lighting time on download

Prerequisites for visibility

- Parameter window [Configuration](#) \ Parameter [Enable output X](#) \ Option *Yes*
- Parameter window [Switch Actuator X](#) \ Parameter window [Functions Switch Actuator](#) \ Parameter [Enable function Time](#) \ Option *Staircase lighting*
- Parameter window [Switch Actuator X](#) \ Parameter window [Staircase lighting](#) \ Parameter [Parameter setting](#) \ Option *Individual*
- The parameter is in the parameter window [Switch Actuator X](#) \ parameter window [Staircase lighting](#).

7.4.71 Change staircase lighting time via Group Object

This parameter is used to define whether the staircase lighting time set in ETS can be changed via the Group Object [Staircase lighting time](#).

i Note

The changed staircase lighting time is used only the next time the function [Staircase lighting](#) is retrieved.

Option

<i>No</i>	The staircase lighting time can be defined only in ETS.
<i>Yes</i>	The following dependent parameters are shown: <ul style="list-style-type: none"> • Overwrite staircase lighting time on download The following dependent Group Objects are displayed: <ul style="list-style-type: none"> • Staircase lighting time

Prerequisites for visibility

- Parameter window [Configuration](#) \ Parameter [Enable output X](#) \ Option *Yes*
- Parameter window [Switch Actuator X](#) \ Parameter window [Functions Switch Actuator](#) \ Parameter [Enable function Time](#) \ Option *Staircase lighting*
- Parameter window [Switch Actuator X](#) \ Parameter window [Staircase lighting](#) \ Parameter [Parameter setting](#) \ Option *Individual*
- The parameter is in the parameter window [Switch Actuator X](#) \ parameter window [Staircase lighting](#).

7.4.72 Staircase lighting time extendable (pumping)

This parameter is used to define how often the staircase lighting time can be extended.

Option	
<i>No, can only be started again</i>	The staircase lighting time can be restarted any number of times by further On telegrams.
<i>Up to max. 2x staircase lighting time</i>	The staircase lighting time can be extended up to twice the duration. Extension occurs when further On telegrams are received after switching on.
<i>Up to max. 3x staircase lighting time</i>	The staircase lighting time can be extended up to three times the duration. Extension occurs when further On telegrams are received after switching on.
<i>Up to max. 4x staircase lighting time</i>	The staircase lighting time can be extended up to four times the duration. Extension occurs when further On telegrams are received after switching on.
<i>Up to max. 5x staircase lighting time</i>	The staircase lighting time can be extended up to five times the duration. Extension occurs when further On telegrams are received after switching on.

Prerequisites for visibility

- Parameter window [Configuration](#) \ Parameter [Enable output X](#) \ Option [Yes](#)
- Parameter window [Switch Actuator X](#) \ Parameter window [Functions Switch Actuator](#) \ Parameter [Enable function Time](#) \ Option [Staircase lighting](#)
- Parameter window [Switch Actuator X](#) \ Parameter window [Staircase lighting](#)
 - Parameter [Parameter setting](#) \ Option [Individual](#)
 - Parameter [Staircase lighting time can be started again](#) \ Option [Yes](#)
- The parameter is in the parameter window [Switch Actuator X](#) \ parameter window [Staircase lighting](#).

7.4.73 Lower threshold

This parameter is used to define the lower threshold. Default values and units depend on the option selected in the [Data point type of Group Object "Threshold input"](#) parameter.

Option	
<i>0 ... 20 ... 100 %</i>	Lower threshold on selection of DPT 5.001.
<i>0 ... 100 ... 255</i>	Lower threshold on selection of DPT 5.010.
<i>0 ... 10,000 ... 65535</i>	Lower threshold on selection of DPT 7.001.
<i>-100 ... 18 ... 250 °C</i>	Lower threshold on selection of DPT 9.001.
<i>0 ... 100 ... 100,000 lux</i>	Lower threshold on selection of DPT 9.004.
<i>0 ... 1000 ... 240000 mA</i>	Lower threshold on selection of DPT 9.021.
<i>0 ... 1 ... 24 A</i>	Lower threshold on selection of DPT 14.019.
<i>0 ... 40 ... 10000 W</i>	Lower threshold on selection of DPT 14.056.
<i>0 ... 1 ... 10 kW</i>	Lower threshold on selection of DPT 9.024.
<i>0 ... 1000 ... 2147483647 Wh</i>	Lower threshold on selection of DPT 13.010.
<i>0 ... 25 ... 2147483647 kWh</i>	Lower threshold on selection of DPT 13.013.

Prerequisites for visibility

- Parameter window [Configuration](#) \ Parameter [Enable Logic/Threshold x-y](#) \ Option [Yes](#)
- Parameter window [Logic/Threshold](#) \ Parameter window [Logic/Threshold x](#) \ Parameter [Function of the logic gate](#) \ Option [Threshold](#)
- The parameter is in the parameter window [Logic/Threshold](#) \ parameter window [Logic/Threshold x](#).

7.4.74 Reaction on result "0" [Switch Actuator]

This parameter is used to define the reaction of the output if the result of the Logic or Threshold function is 0.

The result does not necessarily lead to the position of the relay contact changing.

i Note

Whether the relay contact is opened or closed depends on the following factors:

- Parameterization of the output → [Function diagram Switch Actuator, Page 40](#)
- Priorities → [Priorities, Page 147](#)
- Setting in the parameter [Reaction of output](#)

Option

<i>No reaction</i>	The position of the relay contact remains unchanged.
<i>On</i>	This acts like an On telegram on the Group Object Switch .
<i>Off</i>	This acts like an Off telegram on the Group Object Switch .

Prerequisites for visibility

- Parameter window [Configuration](#) \ Parameter [Enable output X](#) \ Option *Yes*
- Parameter window [Switch Actuator X](#) \ Parameter window [Functions Switch Actuator](#) \ Parameter [Output reacts to](#) \ Option *Logic/Threshold x*
- The parameter is in the parameter window [Switch Actuator X](#) \ parameter window [Functions Switch Actuator](#).

7.4.75 Reaction on result "1" [Switch Actuator]

This parameter is used to define the reaction of the output if the result of the Logic or Threshold function is 1.

The result does not necessarily lead to the position of the relay contact changing.

i Note

Whether the relay contact is opened or closed depends on the following factors:

- Parameterization of the output → [Function diagram Switch Actuator, Page 40](#)
- Priorities → [Priorities, Page 147](#)
- Setting in the parameter [Reaction of output](#)

Option

<i>No reaction</i>	The position of the relay contact remains unchanged.
<i>On</i>	This acts like an On telegram on the Group Object Switch .
<i>Off</i>	This acts like an Off telegram on the Group Object Switch .

Prerequisites for visibility

- Parameter window [Configuration](#) \ Parameter [Enable output X](#) \ Option *Yes*
- Parameter window [Switch Actuator X](#) \ Parameter window [Functions Switch Actuator](#) \ Parameter [Output reacts to](#) \ Option *Logic/Threshold x*
- The parameter is in the parameter window [Switch Actuator X](#) \ parameter window [Functions Switch Actuator](#).

7.4.76 Reaction on Scene recall

This parameter is used to define the reaction of the output on Scene recall.

The Scene recall does not necessarily lead to the position of the relay contact changing.

i Note

Whether the relay contact is opened or closed depends on the following factors:

- Parameterization of the output → [Function diagram Switch Actuator, Page 40](#)
- Priorities → [Priorities, Page 147](#)
- Setting in the parameter *Reaction of output*

Option

<i>On</i>	This acts like an On telegram on the Group Object Switch .
<i>Off</i>	This acts like an Off telegram on the Group Object Switch .

Prerequisites for visibility

- Parameter window [Configuration](#) \ Parameter [Enable output X](#) \ Option Yes
- Parameter window [Switch Actuator X](#) \ Parameter window [Functions Switch Actuator](#) \ Parameter [Enable function Scenes \[Switch Actuator\]](#) \ Option Yes
- Parameter window [Switch Actuator X](#) \ Parameter window [Scene assignments \[Switch Actuator\]](#)
 - Parameter [Parameter setting](#) \ Option *Individual*
 - Parameter [Enable Scene assignment x \[Switch Actuator\]](#) \ Option Yes
- The parameter is in the parameter window [Switch Actuator X](#) \ parameter window [Scene assignments \[Switch Actuator\]](#).

7.4.77 Reaction of output

This parameter is used to define how the output reacts on receipt of a switching telegram on the Group Object [Switch](#).

Option

<i>NC contact</i>	The relay contact is opened with an On telegram (1) and closed with an Off telegram (0).
<i>NO contact</i>	The relay contact is closed with an On telegram (1) and opened with an Off telegram (0).

Prerequisites for visibility

- Parameter window [Configuration](#) \ Parameter [Enable output X](#) \ Option Yes
- Parameter window [Switch Actuator X](#) \ Parameter window [Basic settings \[Switch Actuator\]](#) \ Parameter [Parameter setting](#) \ Option *Individual*
- The parameter is in the parameter window [Switch Actuator X](#) \ parameter window [Basic settings \[Switch Actuator\]](#).

7.4.78 Reaction after flashing

This parameter is used to define the position of the relay contact after the end of the function *Flashing*.

Ending the function does not necessarily lead to the position of the relay contact changing.

i Note

Whether the relay contact is opened or closed depends on the following factors:

- Parameterization of the output → [Function diagram Switch Actuator, Page 40](#)
- Priorities → [Priorities, Page 147](#)
- Setting in the parameter *Reaction of output*

Option

<i>Off</i>	This acts like an Off telegram on the Group Object <i>Switch</i> .
<i>On</i>	This acts like an On telegram on the Group Object <i>Switch</i> .
<i>Refreshed KNX state</i>	The refreshed KNX state is used. → Refreshed KNX state, Page 150

Prerequisites for visibility

- Parameter window [Configuration](#) \ Parameter [Enable output X](#) \ Option *Yes*
- Parameter window [Switch Actuator X](#) \ Parameter window [Functions Switch Actuator](#) \ Parameter [Enable function Time](#) \ Option *Flashing*
- Parameter window [Switch Actuator X](#) \ Parameter window [Flashing](#) \ Parameter [Parameter setting](#) \ Option *Individual*
- The parameter is in the parameter window [Switch Actuator X](#) \ parameter window [Flashing](#).

7.4.79 Reaction after bus voltage recovery [Switch Actuator]

This parameter is used to define the reaction after bus voltage recovery.



CAUTION

If the function *Logic* or the function *Threshold* is connected to the output, double switching behavior may occur after bus voltage recovery and after ETS download.

- ▶ Select option *Calculate contact position*.

Note

Writing to the Group Object *Switch* does not necessarily result in a change to the position of the relay contact due to the priorities and the parameterization of the output.

The value of the Group Object *Switch* can be read correctly only after a new value has been received via the bus (ABB i-bus® KNX).

Note

If the relays are switched manually using the toggle switches, KNX operation is overridden. Manually set contact positions are not detected by the device and are not set again automatically after bus voltage recovery or after ETS download.

Note

The relay contact position must be known to the device to ensure the following functions:

- Sending the status via the Group Object *Status Switch*

The relay contact position is known to the device if one of the following conditions is met after bus voltage recovery or ETS download.

- Reception of a switch telegram via the bus (ABB i-bus® KNX)
- Specification of the value on the Group Object *Switch* with corresponding parametrization
- Specification of the contact position by one of the safety functions or by the function *Load shedding*

Option	
Write Group Object "Switch" with 0	The value 0 is written to the Group Object.
Write Group Object "Switch" with 1	The value 1 is written to the Group Object.
<u>Calculate contact position</u>	<p>The position of the relay contact is calculated in the following situations:</p> <ul style="list-style-type: none"> • If the function <i>Staircase lighting</i> was active before bus voltage failure or download, the function is activated, the relay contact switched to the corresponding position and the staircase lighting time restarted. • If a safety function is active, the relay contact is switched to the position specified with the highest priority in the safety function → Switch Actuator safety functions, Page 41. • When a load shedding stage is active, the relay contact is switched to the defined position → Parameter Switching reaction on active load shedding stage. • If the position of the relay contact has been changed by mechanical action or switching via a toggle switch, the last contact position known to the device is set. <p>In all other cases, the current contact position remains unchanged and the contact position is unknown to the device.</p>
<u>Switching only if safety function active</u>	<p>If a safety function is active, the relay contact is switched to the position specified with the highest priority in the safety function → Switch Actuator safety functions, Page 41.</p> <p>If no safety function is active, the current contact position remains unchanged and the relay contact position is unknown to the device.</p>

Prerequisites for visibility

- Parameter window [Configuration](#) \ Parameter [Enable output X](#) \ Option *Yes*
- Parameter window [Switch Actuator X](#) \ Parameter window [Basic settings \[Switch Actuator\]](#) \ Parameter [Parameter setting](#) \ Option *Individual*
- The parameter is in the parameter window [Switch Actuator X](#) \ parameter window [Basic settings \[Switch Actuator\]](#).

7.4.80

Reaction after ETS download [Switch Actuator]

This parameter is used to define the reaction after ETS download.



CAUTION

If the function *Logic* or the function *Threshold* is connected to the output, double switching behavior may occur after bus voltage recovery and after ETS download.

- ▶ Select option *Calculate contact position*.

Note

Writing to the Group Object *Switch* does not necessarily result in a change to the position of the relay contact due to the priorities and the parameterization of the output.
The value of the Group Object *Switch* can be read correctly only after a new value has been received via the bus (ABB i-bus® KNX).

Note

If the relays are switched manually using the toggle switches, KNX operation is overridden. Manually set contact positions are not detected by the device and are not set again automatically after bus voltage recovery or after ETS download.

Note

The relay contact position must be known to the device to ensure the following functions:

- Sending the status via the Group Object *Status Switch*

The relay contact position is known to the device if one of the following conditions is met after bus voltage recovery or ETS download.

- Reception of a switch telegram via the bus (ABB i-bus® KNX)
- Specification of the value on the Group Object *Switch* with corresponding parametrization
- Specification of the contact position by one of the safety functions or by the function *Load shedding*

Option	
<i>Write Group Object "Switch" with 0</i>	The value 0 is written to the Group Object.
<i>Write Group Object "Switch" with 1</i>	The value 1 is written to the Group Object.
<i>Calculate contact position</i>	<p>The position of the relay contact is calculated in the following situations:</p> <ul style="list-style-type: none"> • If the function <i>Staircase lighting</i> was active before bus voltage failure or download, the function is activated, the relay contact switched to the corresponding position and the staircase lighting time restarted. • If a safety function is active, the relay contact is switched to the position specified with the highest priority in the safety function → Switch Actuator safety functions, Page 41. • When a load shedding stage is active, the relay contact is switched to the defined position → Parameter Switching reaction on active load shedding stage. • If the position of the relay contact has been changed by mechanical action or switching via a toggle switch, the last contact position known to the device is set. <p>In all other cases, the current contact position remains unchanged and the contact position is unknown to the device.</p>
<i>Switching only if safety function active</i>	<p>If a safety function is active, the relay contact is switched to the position specified with the highest priority in the safety function → Switch Actuator safety functions, Page 41.</p> <p>If no safety function is active, the current contact position remains unchanged and the relay contact position is unknown to the device.</p>

Prerequisites for visibility

- Parameter window [Configuration](#) \ Parameter [Enable output X](#) \ Option *Yes*
- Parameter window [Switch Actuator X](#) \ Parameter window [Basic settings \[Switch Actuator\]](#) \ Parameter [Parameter setting](#) \ Option *Individual*
- The parameter is in the parameter window [Switch Actuator X](#) \ parameter window [Basic settings \[Switch Actuator\]](#).

7.4.81 Delay

This parameter is used to define the delay with which the Scene is run after a Scene recall.

Note

If a delay is used for Scene recall (→ parameter *Delay*), the output does not react to the functions *Staircase lighting* and *Delay for switching on and off* → [Function diagram Switch Actuator, Page 40](#).

Note

The delay can be blocked with the Group Object *Block delay for switching on and off*.

Option

00:00:00 ... 12:00:00 hh:mm:ss

Prerequisites for visibility

- Parameter window *Configuration* \ Parameter *Enable output X* \ Option *Yes*
- Parameter window *Switch Actuator X* \ Parameter window *Functions Switch Actuator* \ Parameter *Enable function Scenes [Switch Actuator]* \ Option *Yes*
- Parameter window *Switch Actuator X* \ Parameter window *Scene assignments [Switch Actuator]*
 - Parameter *Parameter setting* \ Option *Individual*
 - Parameter *Enable Scene assignment x [Switch Actuator]* \ Option *Yes*
- The parameter is in the parameter window *Scene assignments [Switch Actuator]*.

7.4.82 Warning before switching off the staircase lighting

This parameter is used to define whether a warning is provided before switching off the output.

More information: → [Function Staircase lighting, Page 52](#).

Option

<i>No</i>	The output is switched off after the staircase lighting time has elapsed.
<i>Via Group Object</i>	<p>After the staircase lighting time has elapsed, a warning is provided via Group Object.</p> <p>The following dependent parameters are shown:</p> <ul style="list-style-type: none"> • <i>Warning time</i> <p>The following dependent Group Objects are displayed:</p> <ul style="list-style-type: none"> • <i>Warning staircase lighting</i>
<i>Short switching off</i>	<p>The output is switched off briefly after the staircase lighting time has elapsed.</p> <p>The following dependent parameters are shown:</p> <ul style="list-style-type: none"> • <i>Number of Off/On changes</i> • <i>Warning time</i>
<i>Via Group Object and short switching off</i>	<p>After the staircase lighting time has elapsed, a warning is provided via Group Object and the output switched off briefly.</p> <p>The following dependent parameters are shown:</p> <ul style="list-style-type: none"> • <i>Number of Off/On changes</i> • <i>Warning time</i> <p>The following dependent Group Objects are displayed:</p> <ul style="list-style-type: none"> • <i>Warning staircase lighting</i>

Prerequisites for visibility

- Parameter window *Configuration* \ Parameter *Enable output X* \ Option *Yes*
- Parameter window *Switch Actuator X* \ Parameter window *Functions Switch Actuator* \ Parameter *Enable function Time* \ Option *Staircase lighting*
- Parameter window *Switch Actuator X* \ Parameter window *Staircase lighting* \ Parameter *Parameter setting* \ Option *Individual*
- The parameter is in the parameter window *Switch Actuator X* \ parameter window *Staircase lighting*.

7.4.83 Warning time

This parameter is used to define the duration of the warning time. The warning time starts after the staircase lighting time has elapsed.

More information: → [Function Staircase lighting, Page 52](#).

Option

00:00:10 ... 00:00:45 ... 18:12:15 hh:mm:ss

Prerequisites for visibility

- Parameter window [Configuration](#) \ Parameter [Enable output X](#) \ Option *Yes*
- Parameter window [Switch Actuator X](#) \ Parameter window [Functions Switch Actuator](#) \ Parameter [Enable function Time](#) \ Option *Staircase lighting*
- Parameter window [Switch Actuator X](#) \ Parameter window [Staircase lighting](#)
 - Parameter [Parameter setting](#) \ Option *Individual*
 - Parameter [Warning before switching off the staircase lighting](#) \ all options except *No*
- The parameter is in the parameter window [Switch Actuator X](#) \ parameter window [Staircase lighting](#).

7.4.84 Send value of Group Object "Status Result"

This parameter is used to define when the value of the following Group Object is sent on the bus (ABB i-bus® KNX):

- [Status Result \[Logic\]](#)

Note

Sending on request can be triggered by the reception of a telegram with the value 0 or 1 on Group Object [Request status values](#).

Option

<i>No, update only</i>	The value is updated but is not sent.
<i>On change</i>	The value is sent if there is a change.
<i>On request</i>	The value is sent on request.
<i>On change or on request</i>	The value is sent on change or on request.
<i>After receiving input value</i>	The value is sent on the input Group Objects after reception of a telegram. The result is recalculated due to the reception of a telegram on the input Group Objects, the result does not necessarily need to change.
<i>After receiving input value or on request</i>	The value is sent on the input Group Objects after reception of a telegram or on request. The result is recalculated due to the reception of a telegram on the input Group Objects, the result does not necessarily need to change.

Prerequisites for visibility

- Parameter window [Configuration](#) \ Parameter [Enable Logic/Threshold x-y](#) \ Option *Yes*
- Parameter window [Logic/Threshold](#) \ Parameter window [Logic/Threshold x](#)
 - Parameter [Function of the logic gate](#) \ Options *AND / OR / Exclusive OR / GATE / 1 bit Inverter*
 - Parameter [Enable Group Object "Status Result"](#) \ Option *Yes*
- The parameter is in the parameter window [Logic/Threshold](#) \ parameter window [Logic/Threshold x](#).

7.4.85 Send value of Group Object "Status Load shedding"

This parameter is used to define when the value of the following Group Object is sent on the bus (ABB i-bus® KNX):

- [Status Load shedding](#)

i Note

Sending on request can be triggered by the reception of a telegram with the value 0 or 1 on Group Object [Request status values](#).

Option	
<i>No, update only</i>	The value is updated but is not sent.
<i>On change</i>	The value is sent if there is a change.
<i>On request</i>	The value is sent on request.
<i>On change or on request</i>	The value is sent on change or on request.

Prerequisites for visibility

- Parameter window [Configuration](#) \ Parameter [Enable output X](#) \ Option *Yes*
- Parameter window [Device settings](#) \ Parameter [Enable central Group Object "Receive load shedding stage"](#) \ Option *Yes*
- Parameter window [Switch Actuator X](#) \ Parameter window [Functions Switch Actuator](#) \ Parameter [Enable function Load shedding](#) \ Option *Yes*
- Parameter window [Switch Actuator X](#) \ Parameter window [Load shedding](#)
 - Parameter [Parameter setting](#) \ Option *Individual*
 - Parameter [Enable group object "Status Load shedding"](#) \ Option *Yes*
- The parameter is in the parameter window [Switch Actuator X](#) \ parameter window [Load shedding](#).

7.4.86 Value of Group Object "Status Switch"

This parameter is used to define the value adopted by the Group Object [Status Switch](#) depending on the position of the relay contact.

Option	
<i>1: closed, 0: open</i>	The Group Object has the value 1 when the relay contact is closed. The Group Object has the value 0 when the relay contact is open.
<i>0: closed, 1: open</i>	The Group Object has the value 0 when the relay contact is closed. The Group Object has the value 1 when the relay contact is open.

Prerequisites for visibility

- Parameter window [Configuration](#) \ Parameter [Enable output X](#) \ Option *Yes*
- Parameter window [Switch Actuator X](#) \ Parameter window [Basic settings \[Switch Actuator\]](#)
 - Parameter [Parameter setting](#) \ Option *Individual*
 - Parameter [Feedback of contact position via Group Object "Status Switch"](#) \ Option *Yes*
- The parameter is in the parameter window [Switch Actuator X](#) \ parameter window [Basic settings \[Switch Actuator\]](#).

7.4.87 Send value of Group Object "Status Switch"

This parameter is used to define when the value of the following Group Object is sent on the bus (ABB i-bus® KNX):

- [Status Switch](#)

i Note

If one of the following options is selected, the value of the Group Object is sent for each switching operation:

- *On change*
- *On change or on request*

i Note

Sending on request can be triggered by the reception of a telegram with the value 0 or 1 on Group Object [Request status values](#).

Option

<i>No, update only</i>	The value is updated but is not sent.
<i>On change</i>	The value is sent if there is a change.
<i>On request</i>	The value is sent on request.
<i>On change or on request</i>	The value is sent on change or on request.

Prerequisites for visibility

- Parameter window [Configuration](#) \ Parameter [Enable output X](#) \ Option Yes
- Parameter window [Switch Actuator X](#) \ Parameter window [Basic settings \[Switch Actuator\]](#)
 - Parameter [Parameter setting](#) \ Option *Individual*
 - Parameter [Feedback of contact position via Group Object "Status Switch"](#) \ Option Yes
- The parameter is in the parameter window [Switch Actuator X](#) \ parameter window [Basic settings \[Switch Actuator\]](#).

7.4.88 Value of Group Object "Connection A" after bus voltage recovery

This parameter is used to define the value that is written to the Group Object [Connection A](#) after bus voltage recovery.

Option

<i>1</i>	The value 1 is written to the Group Object. Writing the Group Object does not affect the result of the function <i>Logic</i> .
<i>0</i>	The value 0 is written to the Group Object. Writing the Group Object does not affect the result of the function <i>Logic</i> .

Prerequisites for visibility

- Parameter window [Configuration](#) \ Parameter [Enable Logic/Threshold x-y](#) \ Option Yes
- Parameter window [Logic/Threshold](#) \ Parameter window [Logic/Threshold x](#) \ Parameter [Function of the logic gate](#) \ Options *AND / OR / Exclusive OR / GATE / 1 bit Inverter*
- The parameter is in the parameter window [Logic/Threshold](#) \ parameter window [Logic/Threshold x](#).

7.4.89 Value of Group Object "Connection B" after bus voltage recovery

This parameter is used to define the value that is written to the Group Object *Connection B* after bus voltage recovery.

Option	
1	The value 1 is written to the Group Object. Writing the Group Object does not affect the result of the function <i>Logic</i> .
0	The value 0 is written to the Group Object. Writing the Group Object does not affect the result of the function <i>Logic</i> .

Prerequisites for visibility

- Parameter window *Configuration* \ Parameter *Enable Logic/Threshold x-y* \ Option *Yes*
- Parameter window *Logic/Threshold* \ Parameter window *Logic/Threshold x* \ Parameter *Function of the logic gate* \ Options *AND / OR / Exclusive OR / GATE*
- The parameter is in the parameter window *Logic/Threshold* \ parameter window *Logic/Threshold x*.

7.4.90 Send value of Group Objects "Status byte" [Switch Actuator]

This parameter is used to define when the values of the following Group Objects are sent on the bus (ABB i-bus® KNX):

- *Status byte all active priorities*
- *Status byte highest active priority*

i Note

If one of the following options is selected, the value of the Group Object is sent for each change in a value:

- *On change*
- *On change or on request*

i Note

Sending on request can be triggered by the reception of a telegram with the value 0 or 1 on Group Object *Request status values*.

Option	
<i>No, update only</i>	The value is updated but is not sent.
<i>On change</i>	The value is sent if there is a change.
<i>On request</i>	The value is sent on request.
<i>On change or on request</i>	The value is sent on change or on request.

Prerequisites for visibility

- Parameter window *Configuration* \ Parameter *Enable output X* \ Option *Yes*
- Parameter window *Switch Actuator X* \ Parameter window *Basic settings [Switch Actuator]*
 - Parameter *Parameter setting* \ Option *Individual*
 - Parameter *Enable Group Objects "Status byte" [Switch Actuator]* \ Options *Yes, all active priorities / Yes, highest active priority*
- The parameter is in the parameter window *Switch Actuator X* \ parameter window *Basic settings [Switch Actuator]*.

7.4.91 Value after sending and switching delay has expired

This parameter is used to define the values that are applicable at the inputs and outputs after expiration of the sending and switching delay.

Option	
<i>Last value received</i>	The inputs and outputs react to the last value received.
<i>Ignore received values</i>	The state of the inputs and outputs remains unchanged until a new value is received after the sending and switching delays have elapsed.

Prerequisites for visibility

- The parameter is in the parameter window [Device settings](#).

7.4.92 Send values of Group Objects "Status Result" and "Status Input value between thresholds"

This parameter is used to define when the values of the following Group Objects are sent on the bus (ABB i-bus® KNX):

- [Status Result \[Threshold\]](#)
- [Status Input value between thresholds](#)

i Note

Sending on request can be triggered by the reception of a telegram with the value 0 or 1 on Group Object [Request status values](#).

Option	
<i>No, update only</i>	The value is updated but is not sent.
<i>On change</i>	The value is sent if there is a change.
<i>On request</i>	The value is sent on request.
<i>On change or on request</i>	The value is sent on change or on request.
<i>After receiving input value</i>	The value is sent on the input Group Objects after reception of a telegram. The result is recalculated due to the reception of a telegram on the input Group Objects, the result does not necessarily need to change.
<i>After receiving input value or on request</i>	The value is sent on the input Group Objects after reception of a telegram or on request. The result is recalculated due to the reception of a telegram on the input Group Objects, the result does not necessarily need to change.

Prerequisites for visibility

- Parameter window [Configuration](#) \ Parameter [Enable Logic/Threshold x-y](#) \ Option *Yes*
- Parameter window [Logic/Threshold](#) \ Parameter window [Logic/Threshold x](#)
 - Parameter [Function of the logic gate](#) \ Option *Threshold*
 - Parameter [Enable Group Objects "Status Result" and "Status Input value between thresholds"](#) \ Option *Yes*
- The parameter is in the parameter window [Logic/Threshold](#) \ [Logic/Threshold x](#).

7.4.93 Time for off

This parameter is used to define how long the output remains switched off during a flashing cycle.

Option

00:00:01 ... 00:00:05 ... 18:12:15 hh:mm:ss

Prerequisites for visibility

- Parameter window [Configuration](#) \ Parameter [Enable output X](#) \ Option *Yes*
- Parameter window [Switch Actuator X](#) \ Parameter window [Functions Switch Actuator](#) \ Parameter [Enable function Time](#) \ Option *Flashing*
- Parameter window [Switch Actuator X](#) \ Parameter window [Flashing](#) \ Parameter [Parameter setting](#) \ Option *Individual*
- The parameter is in the parameter window [Switch Actuator X](#) \ parameter window [Flashing](#).

7.4.94 Time for on

This parameter is used to define how long the output remains switched on during a flashing cycle.

Option

00:00:01 ... 00:00:05 ... 18:12:15 hh:mm:ss

Prerequisites for visibility

- Parameter window [Configuration](#) \ Parameter [Enable output X](#) \ Option *Yes*
- Parameter window [Switch Actuator X](#) \ Parameter window [Functions Switch Actuator](#) \ Parameter [Enable function Time](#) \ Option *Flashing*
- Parameter window [Switch Actuator X](#) \ Parameter window [Flashing](#) \ Parameter [Parameter setting](#) \ Option *Individual*
- The parameter is in the parameter window [Switch Actuator X](#) \ parameter window [Flashing](#).

7.4.95 Enable central Group Object "Receive load shedding stage"

This parameter enables the central Group Object [Receive load shedding stage](#). The device can receive load shedding stages from a master via this Group Object.

All assigned outputs can be activated together with the central Group Object.

Note

Observe the maximum number of switching cycles per minute when using central Group Objects → [Technical data](#).

Option

<i>No</i>	The Group Object is not enabled.
<i>Yes</i>	The following dependent parameters are shown: <ul style="list-style-type: none"> • Enable function Load shedding The following dependent Group Objects are displayed: <ul style="list-style-type: none"> • Receive load shedding stage

Prerequisites for visibility

- The parameter is in the parameter window [Device settings](#).

7.4.96 Enable central Group Object "Switch"

This parameter enables the central Group Object [Switch](#).

All assigned outputs can be activated together with the central Group Object.

i Note

Observe the maximum number of switching cycles per minute when using central Group Objects → [Technical data](#).

Option

<i>No</i>	The Group Object is not enabled.
<i>Yes</i>	The following dependent parameters are shown: <ul style="list-style-type: none"> • Switch output reacts to central Switch Group Object The following dependent Group Objects are displayed: <ul style="list-style-type: none"> • Switch

Prerequisites for visibility

- The parameter is in the parameter window [Device settings](#).

7.4.97 Enable central Group Object "Scene 1 ... 64"

This parameter enables the central Group Object [Scene 1 ... 64](#).

All outputs assigned to the Scene can be activated together with the central Group Object.

i Note

Observe the maximum number of switching cycles per minute when using central Group Objects → [Technical data](#).

Option

<i>No</i>	The Group Object is not enabled.
<i>Yes</i>	The following dependent Group Objects are displayed: <ul style="list-style-type: none"> • Scene 1 ... 64

Prerequisites for visibility

- The parameter is in the parameter window [Device settings](#).

7.4.98 i-bus® Tool access

This parameter is used to define whether the device can be accessed via i-bus® Tool.

More information: → [Integration into i-bus® Tool, Page 56](#).

Option

<i>Deactivated</i>	Access via i-bus® Tool is deactivated.
<i>Value display only</i>	Values can be displayed via the i-bus® Tool.
<i>Full access</i>	Values can be displayed and changed i-bus® Tool.

Prerequisites for visibility

- The parameter is in the parameter window [Configuration](#).

7.4.99 Forced operation (1 bit / 2 bit) [Switch Actuator]

This parameter is used to Activate/Deactivate 1-bit or 2-bit forced operation.

More information: → [forced operation, Page 42](#).

Option	
<i>Deactivated</i>	Forced operation is deactivated.
<i>Activated 1 bit – 0 active</i>	Forced operation is activated by the reception of a telegram with the value 0. <ul style="list-style-type: none"> • Forced operation, 1-bit <p>The following dependent parameters are shown:</p> <ul style="list-style-type: none"> • Switching reaction on forced operation
<i>Activated 1 bit – 1 active</i>	Forced operation is activated by the reception of a telegram with the value 0. <p>The following dependent parameters are shown:</p> <ul style="list-style-type: none"> • Switching reaction on forced operation <p>The following dependent Group Objects are displayed:</p> <ul style="list-style-type: none"> • Forced operation, 1-bit
<i>Activated 2 bit</i>	2-bit forced operation is used. <p>The following dependent Group Objects are displayed:</p> <ul style="list-style-type: none"> • Forced operation, 2-bit

Prerequisites for visibility

- Parameter window [Configuration](#) \ Parameter [Enable output X](#) \ Option *Yes*
- Parameter window [Switch Actuator X](#) \ Parameter window [Functions Switch Actuator](#) \ Parameter [Enable function Safety](#) \ Option *Yes*
- Parameter window [Switch Actuator X](#) \ Parameter window [Safety](#) \ Parameter [Parameter setting](#) \ Option *Individual*
- The parameter is in the parameter window [Switch Actuator X](#) \ parameter window [Safety](#).

7.4.100 Cyclical monitoring

This parameter is used to activate the cyclical monitoring and to define the monitoring cycle for the safety Group Objects. If the monitoring cycle is specified with the value 00:00:00, the cyclical monitoring is deactivated.

More information: → [Cyclical monitoring, Page 151](#).

Note

The monitoring cycle in the device should be at least quadruple the cyclical sending time of the sending device. As a result, the reactions set will not be triggered immediately if a signal is missing, e.g. due to high bus load.

Option	
<i>00:00:00 ... 12:00:00 hh:mm:ss</i>	

Prerequisites for visibility

- Parameter window [Safety](#) \ Parameter [Enable Group Object "Safety priority x"](#) \ Option *Yes*
- The parameter is in the parameter window [Safety](#).

8 Group Objects

8.1 Overview of Group Objects

Function	Group Object name	Data point type	Length	Flags
Block	Channel X: Switch	DPT 1.003	1 bit	C W
Block delay for switching on and off	Channel X: Switch	DPT 1.003	1 bit	C W
Block staircase lighting	Channel X: Switch	DPT 1.003	1 bit	C W
Change lower threshold	Logic/Threshold X: Threshold	DPT 13.010	4 bytes	C W
Change lower threshold	Logic/Threshold X: Threshold	DPT 13.013	4 bytes	C W
Change lower threshold	Logic/Threshold X: Threshold	DPT 14.019	4 bytes	C W
Change lower threshold	Logic/Threshold X: Threshold	DPT 14.056	4 bytes	C W
Change lower threshold	Logic/Threshold X: Threshold	DPT 5.001	1 byte	C W
Change lower threshold	Logic/Threshold X: Threshold	DPT 5.010	1 byte	C W
Change lower threshold	Logic/Threshold X: Threshold	DPT 7.001	2 bytes	C W
Change lower threshold	Logic/Threshold X: Threshold	DPT 9.001	2 bytes	C W
Change lower threshold	Logic/Threshold X: Threshold	DPT 9.004	2 bytes	C W
Change lower threshold	Logic/Threshold X: Threshold	DPT 9.021	2 bytes	C W
Change lower threshold	Logic/Threshold X: Threshold	DPT 9.024	2 bytes	C W
Change upper threshold	Logic/Threshold X: Threshold	DPT 13.010	4 bytes	C W
Change upper threshold	Logic/Threshold X: Threshold	DPT 13.013	4 bytes	C W
Change upper threshold	Logic/Threshold X: Threshold	DPT 14.019	4 bytes	C W
Change upper threshold	Logic/Threshold X: Threshold	DPT 14.056	4 bytes	C W
Change upper threshold	Logic/Threshold X: Threshold	DPT 5.001	1 byte	C W
Change upper threshold	Logic/Threshold X: Threshold	DPT 5.010	1 byte	C W
Change upper threshold	Logic/Threshold X: Threshold	DPT 7.001	2 bytes	C W
Change upper threshold	Logic/Threshold X: Threshold	DPT 9.001	2 bytes	C W
Change upper threshold	Logic/Threshold X: Threshold	DPT 9.004	2 bytes	C W
Change upper threshold	Logic/Threshold X: Threshold	DPT 9.021	2 bytes	C W
Change upper threshold	Logic/Threshold X: Threshold	DPT 9.024	2 bytes	C W
Connection A	Logic/Threshold X: Logic	DPT 1.002	1 bit	C W
Connection B	Logic/Threshold X: Logic	DPT 1.002	1 bit	C W
Flashing	Channel X: Switch	DPT 1.001	1 bit	C W
Forced operation, 1-bit	Channel X: Switch	DPT 1.003	1 bit	C W
Forced operation, 2-bit	Channel X: Switch	DPT 2.001	2 bit	C W
In operation	Central: General	DPT 1.002	1 bit	C R T
Recall Scene assignment x	Channel X: Switch	DPT 1.017	1 bit	C W
Receive load shedding stage	Central: Load shedding	DPT 236.001	1 byte	C W
Request Date/Time	Central: Date/Time	DPT 1.017	1 bit	C T
Request status values	Central: General	DPT 1.017	1 bit	C W
Safety priority x	Safety: Switch	DPT 1.005	1 bit	C W T U
Scene 1 ... 64	Central: Scene	DPT 18.001	1 byte	C W
Scene 1...64	Channel X: Switch	DPT 18.001	1 byte	C W
Set date	Central: Date/Time	DPT 11.001	3 bytes	C W
Set date/time	Central: Date/Time	DPT 19.001	8 bytes	C W
Set load shedding stage	Channel X: Load shedding	DPT 236.001	1 byte	C W
Set time	Central: Date/Time	DPT 10.001	3 bytes	C W
Staircase lighting permanent on	Channel X: Switch	DPT 1.001	1 bit	C W
Staircase lighting time	Channel X: Switch	DPT 7.005	2 bytes	C W
Status byte all active priorities	Channel X: Switch	nonDPT	1 byte	C R T
Status byte highest active priority	Channel X: Switch	nonDPT	1 byte	C R T
Status Input value between thresholds	Logic/Threshold X: Threshold	DPT 1.002	1 bit	C R T
Status Load shedding	Channel X: Load shedding	DPT 1.011	1 bit	C R T
Status Result [Logic]	Logic/Threshold X: Logic	DPT 1.002	1 bit	C R T
Status Result [Threshold]	Logic/Threshold X: Threshold	DPT 1.002	1 bit	C R T
Status Switch	Channel X: Switch	DPT 1.011	1 bit	C R T
Switch	Central: Switch	DPT 1.001	1 bit	C W
Switch	Channel X: Switch	DPT 1.001	1 bit	C W
Threshold input	Logic/Threshold X: Threshold	DPT 13.010	4 bytes	C W T U
Threshold input	Logic/Threshold X: Threshold	DPT 13.013	4 bytes	C W T U
Threshold input	Logic/Threshold X: Threshold	DPT 14.019	4 bytes	C W T U
Threshold input	Logic/Threshold X: Threshold	DPT 14.056	4 bytes	C W T U
Threshold input	Logic/Threshold X: Threshold	DPT 5.001	1 byte	C W T U
Threshold input	Logic/Threshold X: Threshold	DPT 5.010	1 byte	C W T U
Threshold input	Logic/Threshold X: Threshold	DPT 7.001	2 bytes	C W T U
Threshold input	Logic/Threshold X: Threshold	DPT 9.001	2 bytes	C W T U
Threshold input	Logic/Threshold X: Threshold	DPT 9.004	2 bytes	C W T U

Function	Group Object name	Data point type	Length	Flags
Threshold input	Logic/Threshold X: Threshold	DPT 9.021	2 bytes	C W T U
Threshold input	Logic/Threshold X: Threshold	DPT 9.024	2 bytes	C W T U
Warning staircase lighting	Channel X: Switch	DPT 1.001	1 bit	C R T

8.2 Group Objects "Central"

Function	Group Object name	Data point type	Length	Flags
Set date	Central: Date/Time	DPT 11.001	3 bytes	C W

This Group Object is used to receive, via the bus (ABB i-bus® KNX), the date.

Telegram value:

- DD.MM.YYYY



Note

If this Group Object is read, it indicates the last value received. The value may vary from the current device time.

Prerequisites for visibility

- Parameter window [Device settings](#) \ Parameter [Enable Time Group Objects for setting of device time](#) \ Option Date (DPT 11.001)/time (10.001)

Request Date/Time	Central: Date/Time	DPT 1.017	1 bit	C	T
-------------------	--------------------	-----------	-------	---	---

This Group Object sends a date and time request on the bus (ABB i-bus® KNX).

The request is sent 30 seconds after switching on the device. An active send and switching delay is not taken into account.

Telegram value:

- 1 = Trigger
- 0 = Is not sent

Prerequisites for visibility

- Parameter window [Device settings](#) \ Parameter [Enable Time Group Objects for setting of device time](#) \ Option Date (DPT 11.001)/time (10.001) / Date/Time (DPT 19.001)

Set date/time	Central: Date/Time	DPT 19.001	8 bytes	C	W
---------------	--------------------	------------	---------	---	---

This Group Object is used to receive via the bus (ABB i-bus® KNX) the weekday, date and time. The telegram also contains information about the validity of the individual values.

Telegram value:

- Coded 8-byte value



Note

If this Group Object is read, it indicates the last value received. The value may vary from the current device time.

Prerequisites for visibility

- Parameter window [Device settings](#) \ Parameter [Enable Time Group Objects for setting of device time](#) \ Option Date/Time (DPT 19.001)

In operation	Central: General	DPT 1.002	1 bit	C	R	T
--------------	------------------	-----------	-------	---	---	---

This Group Object cyclically sends an In operation telegram on the bus (ABB i-bus® KNX). The sending cycle is set in parameter [Sending cycle](#).

The telegram value depends on the setting in the parameter [Enable Group Object "In operation"](#).

Telegram value:

- 1 = Device in operation
- 0 = Device in operation



Note

Readiness can be monitored by another KNX device using this Group Object. If a telegram is not received, the sending device could be faulty or the bus cable to the transmitting device could be interrupted.

Prerequisites for visibility

- Parameter window [Device settings](#) \ Parameter [Enable Group Object "In operation"](#) \ Option *Yes, send value 0 cyclically / Yes, send value 1 cyclically*

Receive load shedding stage	Central: Load shedding	DPT 236.001	1 byte	C	W
-----------------------------	------------------------	-------------	--------	---	---

This Group Object is used to receive, via the bus (ABB i-bus® KNX), the current load shedding stage.

The Group Object applies to the entire device. The load shedding can be set individually for each output.

More information: → [Function Load shedding, Page 45](#).

Telegram value:

- → [Coding, Group Object "Receive load shedding stage", Page 148](#)

Prerequisites for visibility

- Parameter window [Device settings](#) \ Parameter [Enable central Group Object "Receive load shedding stage"](#) \ Option *Yes*

Function	Group Object name	Data point type	Length	Flags
Switch	Central: Switch	DPT 1.001	1 bit	C W

This Group Object can be used to switch several outputs of the device under central control. In the parameter [Switch output reacts to central Switch Group Object](#), it can be defined individually for each output whether the output reacts to this Group Object.

The switching behavior of the outputs is dependent on the settings in the related parameters [Reaction of output](#).

NO contact telegram value:

- 1 = Close relay contact
- 0 = Open relay contact

NC contact telegram value:

- 1 = Open relay contact
- 0 = Close relay contact

Note

Due to the priorities, a switching command does not necessarily change the position of the relay contact.

Each relay can perform only a limited number of switching operations per minute. Frequent switching can cause a switching delay. More information → [Technical data](#).

Prerequisites for visibility

- Parameter window [Device settings](#) \ Parameter [Enable central Group Object "Switch"](#) \ Option Yes

Request status values	Central: General	DPT 1.017	1 bit	C W
-----------------------	------------------	-----------	-------	-----

If a telegram is received on this Group Object, the values of the status Group Objects are sent on the bus (ABB i-bus® KNX).

Telegram value:

- 1 = Send status values
- 0 = Send status values

Note

The values of the status Group Objects are sent only if sending on request is set in the related parameters.

Prerequisites for visibility

- Parameter window [Device settings](#) \ Parameter [Enable Group Object "Request status values"](#) \ Option Yes

Scene 1 ... 64	Central: Scene	DPT 18.001	1 byte	C W
----------------	----------------	------------	--------	-----

This Group Object can be used to activate several outputs of the device under central control.

This Group Object is used to receive, via the bus (ABB i-bus® KNX), a Scene telegram.

The Scene telegram includes the Scene number and information about whether the Scene is recalled or the position of the relay contact is saved in the Scene.

A Scene number is assigned in the parameter window [Scene assignments \[Switch Actuator\]](#). If the corresponding Scene number is parametrized for an output, the Scene is recalled or saved, depending on the telegram value.

Telegram value:

- 0 ... 63 = Recall Scene x (x = 1 ... 64)
- 128 ... 191 = Save Scene x (x = 1 ... 64)

For more information, see:

→ [Function Scenes, Page 50](#)

→ [Function diagram Switch Actuator, Page 40](#)

→ [Table of values, Group Object "Scene 1 ... 64", Page 155](#)

Note

A telegram does not necessarily result in a change to the position of the relay contact due to the priorities.

Prerequisites for visibility

- Parameter window [Device settings](#) \ Parameter [Enable central Group Object "Scene 1 ... 64"](#) \ Option Yes

Set time	Central: Date/Time	DPT 10.001	3 bytes	C W
----------	--------------------	------------	---------	-----

This Group Object is used to receive via the bus (ABB i-bus® KNX) the weekday and time.

Telegram value:

- DD:hh:mm:ss

Note

If this Group Object is read, it indicates the last value received. The value may vary from the current device time.

Prerequisites for visibility

- Parameter window [Device settings](#) \ Parameter [Enable Time Group Objects for setting of device time](#) \ Option Date (DPT 11.001)/time (10.001)

8.3 Group Objects "Safety"

Function	Group Object name	Data point type	Length	Flags
Safety priority x	Safety: Switch	DPT 1.005	1 bit	C W T U

These Group Objects are used to receive, via the bus (ABB i-bus® KNX), a safety priority.

An active safety priority overrides the operation of the device → [Switch Actuator safety functions, Page 41](#).

Telegram value:

- 1 = Alarm
- 0 = No alarm

i Note

It is necessary to select in the parameter [Read safety Group Objects after bus voltage recovery and download](#) the option *Yes* to update automatically the Group Objects.

i Note

To update the safety Group Objects after bus voltage recovery or download, the read flags must be set for the corresponding Group Objects of the sending device.

Prerequisites for visibility

- Parameter window [Safety](#) \ Parameter [Enable Group Object "Safety priority x"](#) \ Option *Yes*

8.4 Group Objects Logic/Threshold X

Function	Group Object name	Data point type	Length	Flags
Change upper threshold	Logic/Threshold X: Threshold	DPT 13.010	4 bytes	C W

This Group Object is used to receive, via the bus (ABB i-bus® KNX), a new value for the upper threshold.

The data point type for the Group Object depends on the option selected in the parameter [Data point type of Group Object "Threshold input"](#).

Telegram value:

- 0 ... 2147483647 Wh

Prerequisites for visibility

- Parameter window [Configuration](#) \ Parameter [Enable Logic/Threshold x-y](#) \ Option *Yes*
- Parameter window [Logic/Threshold](#) \ Parameter window [Logic/Threshold x](#)
 - Parameter [Function of the logic gate](#) \ Option *Threshold*
 - Parameter [Data point type of Group Object "Threshold input"](#) \ Option *Wh (DPT 13.010)*
 - Parameter [Change thresholds via Group Objects](#) \ Option *Yes*

Change upper threshold	Logic/Threshold X: Threshold	DPT 13.013	4 bytes	C W
------------------------	------------------------------	------------	---------	-----

This Group Object is used to receive, via the bus (ABB i-bus® KNX), a new value for the upper threshold.

The data point type for the Group Object depends on the option selected in the parameter [Data point type of Group Object "Threshold input"](#).

Telegram value:

- 0 ... 2147483647 kWh

Prerequisites for visibility

- Parameter window [Configuration](#) \ Parameter [Enable Logic/Threshold x-y](#) \ Option *Yes*
- Parameter window [Logic/Threshold](#) \ Parameter window [Logic/Threshold x](#)
 - Parameter [Function of the logic gate](#) \ Option *Threshold*
 - Parameter [Data point type of Group Object "Threshold input"](#) \ Option *kWh (DPT 13.013)*
 - Parameter [Change thresholds via Group Objects](#) \ Option *Yes*

Change upper threshold	Logic/Threshold X: Threshold	DPT 14.019	4 bytes	C W
------------------------	------------------------------	------------	---------	-----

This Group Object is used to receive, via the bus (ABB i-bus® KNX), a new value for the upper threshold.

The data point type for the Group Object depends on the option selected in the parameter [Data point type of Group Object "Threshold input"](#).

Telegram value:

- 0 ... 24 A

Prerequisites for visibility

- Parameter window [Configuration](#) \ Parameter [Enable Logic/Threshold x-y](#) \ Option *Yes*
- Parameter window [Logic/Threshold](#) \ Parameter window [Logic/Threshold x](#)
 - Parameter [Function of the logic gate](#) \ Option *Threshold*
 - Parameter [Data point type of Group Object "Threshold input"](#) \ Option *A (DPT 14.019)*
 - Parameter [Change thresholds via Group Objects](#) \ Option *Yes*

Change upper threshold	Logic/Threshold X: Threshold	DPT 14.056	4 bytes	C W
------------------------	------------------------------	------------	---------	-----

This Group Object is used to receive, via the bus (ABB i-bus® KNX), a new value for the upper threshold.

The data point type for the Group Object depends on the option selected in the parameter [Data point type of Group Object "Threshold input"](#).

Telegram value:

- 0 ... 10000 W

Prerequisites for visibility

- Parameter window [Configuration](#) \ Parameter [Enable Logic/Threshold x-y](#) \ Option *Yes*
- Parameter window [Logic/Threshold](#) \ Parameter window [Logic/Threshold x](#)
 - Parameter [Function of the logic gate](#) \ Option *Threshold*
 - Parameter [Data point type of Group Object "Threshold input"](#) \ Option *W (DPT 14.056)*
 - Parameter [Change thresholds via Group Objects](#) \ Option *Yes*

Function	Group Object name	Data point type	Length	Flags	
Change upper threshold	Logic/Threshold X: Threshold	DPT 5.001	1 byte	C	W
<p>This Group Object is used to receive, via the bus (ABB i-bus® KNX), a new value for the upper threshold. The data point type for the Group Object depends on the option selected in the parameter Data point type of Group Object "Threshold input". Telegram value:</p> <ul style="list-style-type: none"> 0 ... 100 % <p>Prerequisites for visibility</p> <ul style="list-style-type: none"> Parameter window Configuration \ Parameter Enable Logic/Threshold x-y \ Option Yes Parameter window Logic/Threshold \ Parameter window Logic/Threshold x <ul style="list-style-type: none"> Parameter Function of the logic gate \ Option Threshold Parameter Data point type of Group Object "Threshold input" \ Option Percent (DPT 5.001) Parameter Change thresholds via Group Objects \ Option Yes 					
Change upper threshold	Logic/Threshold X: Threshold	DPT 5.010	1 byte	C	W
<p>This Group Object is used to receive, via the bus (ABB i-bus® KNX), a new value for the upper threshold. The data point type for the Group Object depends on the option selected in the parameter Data point type of Group Object "Threshold input". Telegram value:</p> <ul style="list-style-type: none"> 0 ... 255 <p>Prerequisites for visibility</p> <ul style="list-style-type: none"> Parameter window Configuration \ Parameter Enable Logic/Threshold x-y \ Option Yes Parameter window Logic/Threshold \ Parameter window Logic/Threshold x <ul style="list-style-type: none"> Parameter Function of the logic gate \ Option Threshold Parameter Data point type of Group Object "Threshold input" \ Option Meter pulses (DPT 5.010) Parameter Change thresholds via Group Objects \ Option Yes 					
Change upper threshold	Logic/Threshold X: Threshold	DPT 7.001	2 bytes	C	W
<p>This Group Object is used to receive, via the bus (ABB i-bus® KNX), a new value for the upper threshold. The data point type for the Group Object depends on the option selected in the parameter Data point type of Group Object "Threshold input". Telegram value:</p> <ul style="list-style-type: none"> 0 ... 65535 <p>Prerequisites for visibility</p> <ul style="list-style-type: none"> Parameter window Configuration \ Parameter Enable Logic/Threshold x-y \ Option Yes Parameter window Logic/Threshold \ Parameter window Logic/Threshold x <ul style="list-style-type: none"> Parameter Function of the logic gate \ Option Threshold Parameter Data point type of Group Object "Threshold input" \ Option Meter pulses (DPT 7.001) Parameter Change thresholds via Group Objects \ Option Yes 					
Change upper threshold	Logic/Threshold X: Threshold	DPT 9.001	2 bytes	C	W
<p>This Group Object is used to receive, via the bus (ABB i-bus® KNX), a new value for the upper threshold. The data point type for the Group Object depends on the option selected in the parameter Data point type of Group Object "Threshold input". Telegram value:</p> <ul style="list-style-type: none"> -273 ... 670760 °C <p>Prerequisites for visibility</p> <ul style="list-style-type: none"> Parameter window Configuration \ Parameter Enable Logic/Threshold x-y \ Option Yes Parameter window Logic/Threshold \ Parameter window Logic/Threshold x <ul style="list-style-type: none"> Parameter Function of the logic gate \ Option Threshold Parameter Data point type of Group Object "Threshold input" \ Option Temperature (DPT 9.001) Parameter Change thresholds via Group Objects \ Option Yes 					
Change upper threshold	Logic/Threshold X: Threshold	DPT 9.004	2 bytes	C	W
<p>This Group Object is used to receive, via the bus (ABB i-bus® KNX), a new value for the upper threshold. The data point type for the Group Object depends on the option selected in the parameter Data point type of Group Object "Threshold input". Telegram value:</p> <ul style="list-style-type: none"> 0 ... 670760 lux <p>Prerequisites for visibility</p> <ul style="list-style-type: none"> Parameter window Configuration \ Parameter Enable Logic/Threshold x-y \ Option Yes Parameter window Logic/Threshold \ Parameter window Logic/Threshold x <ul style="list-style-type: none"> Parameter Function of the logic gate \ Option Threshold Parameter Data point type of Group Object "Threshold input" \ Option Lux (DPT 9.004) Parameter Change thresholds via Group Objects \ Option Yes 					
Change upper threshold	Logic/Threshold X: Threshold	DPT 9.021	2 bytes	C	W
<p>This Group Object is used to receive, via the bus (ABB i-bus® KNX), a new value for the upper threshold. The data point type for the Group Object depends on the option selected in the parameter Data point type of Group Object "Threshold input". Telegram value:</p> <ul style="list-style-type: none"> 0 ... 240000 mA <p>Prerequisites for visibility</p> <ul style="list-style-type: none"> Parameter window Configuration \ Parameter Enable Logic/Threshold x-y \ Option Yes Parameter window Logic/Threshold \ Parameter window Logic/Threshold x <ul style="list-style-type: none"> Parameter Function of the logic gate \ Option Threshold Parameter Data point type of Group Object "Threshold input" \ Option mA (DPT 9.021) Parameter Change thresholds via Group Objects \ Option Yes 					

Function	Group Object name	Data point type	Length	Flags
Change upper threshold	Logic/Threshold X: Threshold	DPT 9.024	2 bytes	C W
<p>This Group Object is used to receive, via the bus (ABB i-bus® KNX), a new value for the upper threshold. The data point type for the Group Object depends on the option selected in the parameter Data point type of Group Object "Threshold input". Telegram value:</p> <ul style="list-style-type: none"> 0 ... 10 kW <p>Prerequisites for visibility</p> <ul style="list-style-type: none"> Parameter window Configuration \ Parameter Enable Logic/Threshold x-y \ Option Yes Parameter window Logic/Threshold \ Parameter window Logic/Threshold x <ul style="list-style-type: none"> Parameter Function of the logic gate \ Option Threshold Parameter Data point type of Group Object "Threshold input" \ Option kW (DPT 9.024) Parameter Change thresholds via Group Objects \ Option Yes 				
Threshold input	Logic/Threshold X: Threshold	DPT 13.010	4 bytes	C W T U
<p>This Group Object is used to receive, via the bus (ABB i-bus® KNX), the input value for the function Threshold. The data point type for the Group Object depends on the option selected in the parameter Data point type of Group Object "Threshold input". Telegram value:</p> <ul style="list-style-type: none"> 0 ... 2147483647 Wh <p>Note It is necessary to select in the parameter Read input Group Objects after bus voltage recovery and download the option Yes to update automatically the Group Object.</p> <p>Note To update the input Group Objects after bus voltage recovery or download, the read flags must be set for the corresponding Group Objects of the sending device.</p> <p>Prerequisites for visibility</p> <ul style="list-style-type: none"> Parameter window Configuration \ Parameter Enable Logic/Threshold x-y \ Option Yes Parameter window Logic/Threshold \ Parameter window Logic/Threshold x <ul style="list-style-type: none"> Parameter Function of the logic gate \ Option Threshold Parameter Data point type of Group Object "Threshold input" \ Option Wh (DPT 13.010) 				
Threshold input	Logic/Threshold X: Threshold	DPT 13.013	4 bytes	C W T U
<p>This Group Object is used to receive, via the bus (ABB i-bus® KNX), the input value for the function Threshold. The data point type for the Group Object depends on the option selected in the parameter Data point type of Group Object "Threshold input". Telegram value:</p> <ul style="list-style-type: none"> 0 ... 2147483647 kWh <p>Note It is necessary to select in the parameter Read input Group Objects after bus voltage recovery and download the option Yes to update automatically the Group Object.</p> <p>Note To update the input Group Objects after bus voltage recovery or download, the read flags must be set for the corresponding Group Objects of the sending device.</p> <p>Prerequisites for visibility</p> <ul style="list-style-type: none"> Parameter window Configuration \ Parameter Enable Logic/Threshold x-y \ Option Yes Parameter window Logic/Threshold \ Parameter window Logic/Threshold x <ul style="list-style-type: none"> Parameter Function of the logic gate \ Option Threshold Parameter Data point type of Group Object "Threshold input" \ Option kWh (DPT 13.013) 				
Threshold input	Logic/Threshold X: Threshold	DPT 14.019	4 bytes	C W T U
<p>This Group Object is used to receive, via the bus (ABB i-bus® KNX), the input value for the function Threshold. The data point type for the Group Object depends on the option selected in the parameter Data point type of Group Object "Threshold input". Telegram value:</p> <ul style="list-style-type: none"> 0 ... 24 A <p>Note It is necessary to select in the parameter Read input Group Objects after bus voltage recovery and download the option Yes to update automatically the Group Object.</p> <p>Note To update the input Group Objects after bus voltage recovery or download, the read flags must be set for the corresponding Group Objects of the sending device.</p> <p>Prerequisites for visibility</p> <ul style="list-style-type: none"> Parameter window Configuration \ Parameter Enable Logic/Threshold x-y \ Option Yes Parameter window Logic/Threshold \ Parameter window Logic/Threshold x <ul style="list-style-type: none"> Parameter Function of the logic gate \ Option Threshold Parameter Data point type of Group Object "Threshold input" \ Option A (DPT 14.019) 				

Function	Group Object name	Data point type	Length	Flags
Threshold input	Logic/Threshold X: Threshold	DPT 14.056	4 bytes	C W T U
<p>This Group Object is used to receive, via the bus (ABB i-bus® KNX), the input value for the function <i>Threshold</i>. The data point type for the Group Object depends on the option selected in the parameter <i>Data point type of Group Object "Threshold input"</i>. Telegram value:</p> <ul style="list-style-type: none"> 0 ... 10000 W 				
<p>Note It is necessary to select in the parameter <i>Read input Group Objects after bus voltage recovery and download</i> the option <i>Yes</i> to update automatically the Group Object.</p>				
<p>Note To update the input Group Objects after bus voltage recovery or download, the read flags must be set for the corresponding Group Objects of the sending device.</p>				
<p>Prerequisites for visibility</p> <ul style="list-style-type: none"> Parameter window <i>Configuration</i> \ Parameter <i>Enable Logic/Threshold x-y</i> \ Option <i>Yes</i> Parameter window <i>Logic/Threshold</i> \ Parameter window <i>Logic/Threshold x</i> <ul style="list-style-type: none"> Parameter <i>Function of the logic gate</i> \ Option <i>Threshold</i> Parameter <i>Data point type of Group Object "Threshold input"</i> \ Option <i>W (DPT 14.056)</i> 				
Threshold input	Logic/Threshold X: Threshold	DPT 5.001	1 byte	C W T U
<p>This Group Object is used to receive, via the bus (ABB i-bus® KNX), the input value for the function <i>Threshold</i>. The data point type for the Group Object depends on the option selected in the parameter <i>Data point type of Group Object "Threshold input"</i>. Telegram value:</p> <ul style="list-style-type: none"> 0 ... 100 % 				
<p>Note It is necessary to select in the parameter <i>Read input Group Objects after bus voltage recovery and download</i> the option <i>Yes</i> to update automatically the Group Object.</p>				
<p>Note To update the input Group Objects after bus voltage recovery or download, the read flags must be set for the corresponding Group Objects of the sending device.</p>				
<p>Prerequisites for visibility</p> <ul style="list-style-type: none"> Parameter window <i>Configuration</i> \ Parameter <i>Enable Logic/Threshold x-y</i> \ Option <i>Yes</i> Parameter window <i>Logic/Threshold</i> \ Parameter window <i>Logic/Threshold x</i> <ul style="list-style-type: none"> Parameter <i>Function of the logic gate</i> \ Option <i>Threshold</i> Parameter <i>Data point type of Group Object "Threshold input"</i> \ Option <i>Percent (DPT 5.001)</i> 				
Threshold input	Logic/Threshold X: Threshold	DPT 5.010	1 byte	C W T U
<p>This Group Object is used to receive, via the bus (ABB i-bus® KNX), the input value for the function <i>Threshold</i>. The data point type for the Group Object depends on the option selected in the parameter <i>Data point type of Group Object "Threshold input"</i>. Telegram value:</p> <ul style="list-style-type: none"> 0 ... 255 				
<p>Note It is necessary to select in the parameter <i>Read input Group Objects after bus voltage recovery and download</i> the option <i>Yes</i> to update automatically the Group Object.</p>				
<p>Note To update the input Group Objects after bus voltage recovery or download, the read flags must be set for the corresponding Group Objects of the sending device.</p>				
<p>Prerequisites for visibility</p> <ul style="list-style-type: none"> Parameter window <i>Configuration</i> \ Parameter <i>Enable Logic/Threshold x-y</i> \ Option <i>Yes</i> Parameter window <i>Logic/Threshold</i> \ Parameter window <i>Logic/Threshold x</i> <ul style="list-style-type: none"> Parameter <i>Function of the logic gate</i> \ Option <i>Threshold</i> Parameter <i>Data point type of Group Object "Threshold input"</i> \ Option <i>Meter pulses (DPT 5.010)</i> 				
Threshold input	Logic/Threshold X: Threshold	DPT 7.001	2 bytes	C W T U
<p>This Group Object is used to receive, via the bus (ABB i-bus® KNX), the input value for the function <i>Threshold</i>. The data point type for the Group Object depends on the option selected in the parameter <i>Data point type of Group Object "Threshold input"</i>. Telegram value:</p> <ul style="list-style-type: none"> 0 ... 65535 				
<p>Note It is necessary to select in the parameter <i>Read input Group Objects after bus voltage recovery and download</i> the option <i>Yes</i> to update automatically the Group Object.</p>				
<p>Note To update the input Group Objects after bus voltage recovery or download, the read flags must be set for the corresponding Group Objects of the sending device.</p>				
<p>Prerequisites for visibility</p> <ul style="list-style-type: none"> Parameter window <i>Configuration</i> \ Parameter <i>Enable Logic/Threshold x-y</i> \ Option <i>Yes</i> Parameter window <i>Logic/Threshold</i> \ Parameter window <i>Logic/Threshold x</i> <ul style="list-style-type: none"> Parameter <i>Function of the logic gate</i> \ Option <i>Threshold</i> Parameter <i>Data point type of Group Object "Threshold input"</i> \ Option <i>Meter pulses (DPT 7.001)</i> 				

Function	Group Object name	Data point type	Length	Flags
Threshold input	Logic/Threshold X: Threshold	DPT 9.001	2 bytes	C W T U
<p>This Group Object is used to receive, via the bus (ABB i-bus® KNX), the input value for the function <i>Threshold</i>. The data point type for the Group Object depends on the option selected in the parameter <i>Data point type of Group Object "Threshold input"</i>. Telegram value:</p> <ul style="list-style-type: none"> -273 ... 670760 °C 				
<p>Note It is necessary to select in the parameter <i>Read input Group Objects after bus voltage recovery and download</i> the option <i>Yes</i> to update automatically the Group Object.</p>				
<p>Note To update the input Group Objects after bus voltage recovery or download, the read flags must be set for the corresponding Group Objects of the sending device.</p>				
<p>Prerequisites for visibility</p> <ul style="list-style-type: none"> Parameter window <i>Configuration</i> \ Parameter <i>Enable Logic/Threshold x-y</i> \ Option <i>Yes</i> Parameter window <i>Logic/Threshold</i> \ Parameter window <i>Logic/Threshold x</i> <ul style="list-style-type: none"> Parameter <i>Function of the logic gate</i> \ Option <i>Threshold</i> Parameter <i>Data point type of Group Object "Threshold input"</i> \ Option <i>Temperature (DPT 9.001)</i> 				
Threshold input	Logic/Threshold X: Threshold	DPT 9.004	2 bytes	C W T U
<p>This Group Object is used to receive, via the bus (ABB i-bus® KNX), the input value for the function <i>Threshold</i>. The data point type for the Group Object depends on the option selected in the parameter <i>Data point type of Group Object "Threshold input"</i>. Telegram value:</p> <ul style="list-style-type: none"> 0 ... 670760 lux 				
<p>Note It is necessary to select in the parameter <i>Read input Group Objects after bus voltage recovery and download</i> the option <i>Yes</i> to update automatically the Group Object.</p>				
<p>Note To update the input Group Objects after bus voltage recovery or download, the read flags must be set for the corresponding Group Objects of the sending device.</p>				
<p>Prerequisites for visibility</p> <ul style="list-style-type: none"> Parameter window <i>Configuration</i> \ Parameter <i>Enable Logic/Threshold x-y</i> \ Option <i>Yes</i> Parameter window <i>Logic/Threshold</i> \ Parameter window <i>Logic/Threshold x</i> <ul style="list-style-type: none"> Parameter <i>Function of the logic gate</i> \ Option <i>Threshold</i> Parameter <i>Data point type of Group Object "Threshold input"</i> \ Option <i>Lux (DPT 9.004)</i> 				
Threshold input	Logic/Threshold X: Threshold	DPT 9.021	2 bytes	C W T U
<p>This Group Object is used to receive, via the bus (ABB i-bus® KNX), the input value for the function <i>Threshold</i>. The data point type for the Group Object depends on the option selected in the parameter <i>Data point type of Group Object "Threshold input"</i>. Telegram value:</p> <ul style="list-style-type: none"> 0 ... 240000 mA 				
<p>Note It is necessary to select in the parameter <i>Read input Group Objects after bus voltage recovery and download</i> the option <i>Yes</i> to update automatically the Group Object.</p>				
<p>Note To update the input Group Objects after bus voltage recovery or download, the read flags must be set for the corresponding Group Objects of the sending device.</p>				
<p>Prerequisites for visibility</p> <ul style="list-style-type: none"> Parameter window <i>Configuration</i> \ Parameter <i>Enable Logic/Threshold x-y</i> \ Option <i>Yes</i> Parameter window <i>Logic/Threshold</i> \ Parameter window <i>Logic/Threshold x</i> <ul style="list-style-type: none"> Parameter <i>Function of the logic gate</i> \ Option <i>Threshold</i> Parameter <i>Data point type of Group Object "Threshold input"</i> \ Option <i>mA (DPT 9.021)</i> 				
Threshold input	Logic/Threshold X: Threshold	DPT 9.024	2 bytes	C W T U
<p>This Group Object is used to receive, via the bus (ABB i-bus® KNX), the input value for the function <i>Threshold</i>. The data point type for the Group Object depends on the option selected in the parameter <i>Data point type of Group Object "Threshold input"</i>. Telegram value:</p> <ul style="list-style-type: none"> 0 ... 10 kW 				
<p>Note It is necessary to select in the parameter <i>Read input Group Objects after bus voltage recovery and download</i> the option <i>Yes</i> to update automatically the Group Object.</p>				
<p>Note To update the input Group Objects after bus voltage recovery or download, the read flags must be set for the corresponding Group Objects of the sending device.</p>				
<p>Prerequisites for visibility</p> <ul style="list-style-type: none"> Parameter window <i>Configuration</i> \ Parameter <i>Enable Logic/Threshold x-y</i> \ Option <i>Yes</i> Parameter window <i>Logic/Threshold</i> \ Parameter window <i>Logic/Threshold x</i> <ul style="list-style-type: none"> Parameter <i>Function of the logic gate</i> \ Option <i>Threshold</i> Parameter <i>Data point type of Group Object "Threshold input"</i> \ Option <i>kW (DPT 9.024)</i> 				

Function	Group Object name	Data point type	Length	Flags
Status Input value between thresholds	Logic/Threshold X: Threshold	DPT 1.002	1 bit	C R T
This Group Object sends the value 1 on the bus (ABB i-bus® KNX) if the input value for the function <i>Threshold</i> is between the thresholds. More information: → Function Threshold, Page 43 . Telegram value:				
<ul style="list-style-type: none"> • 1 = Input value is between the thresholds (logically true) • 0 = Input value is not between the thresholds (logically false) 				
Prerequisites for visibility				
<ul style="list-style-type: none"> • Parameter window Configuration \ Parameter Enable Logic/Threshold x-y \ Option <i>Yes</i> • Parameter window Logic/Threshold \ Parameter window Logic/Threshold x <ul style="list-style-type: none"> – Parameter Function of the logic gate \ Option <i>Threshold</i> – Parameter Monitor range between thresholds \ Option <i>Yes</i> – Parameter Enable Group Objects "Status Result" and "Status Input value between thresholds" \ Option <i>Yes</i> 				
Status Result [Logic]	Logic/Threshold X: Logic	DPT 1.002	1 bit	C R T
This Group Object sends the result of the function <i>Logic</i> on the bus (ABB i-bus® KNX). More information: → Function Logic, Page 42 . Telegram value:				
<ul style="list-style-type: none"> • 1 = Logically true • 0 = Logically false 				
Note				
The result can be inverted → parameter Invert result .				
Prerequisites for visibility				
<ul style="list-style-type: none"> • Parameter window Configuration \ Parameter Enable Logic/Threshold x-y \ Option <i>Yes</i> • Parameter window Logic/Threshold \ Parameter window Logic/Threshold x <ul style="list-style-type: none"> – Parameter Function of the logic gate \ Option <i>AND / OR / Exclusive OR / GATE / 1 bit Inverter</i> – Parameter Enable Group Object "Status Result" \ Option <i>Yes</i> 				
Status Result [Threshold]	Logic/Threshold X: Threshold	DPT 1.002	1 bit	C R T
This Group Object sends the result of the function <i>Threshold</i> on the bus (ABB i-bus® KNX). More information: → Function Threshold, Page 43 . Telegram value:				
<ul style="list-style-type: none"> • Dependent on the settings in the following parameters: <ul style="list-style-type: none"> – Result if upper threshold is exceeded – Result if lower threshold is dropped below 				
Prerequisites for visibility				
<ul style="list-style-type: none"> • Parameter window Configuration \ Parameter Enable Logic/Threshold x-y \ Option <i>Yes</i> • Parameter window Logic/Threshold \ Parameter window Logic/Threshold x <ul style="list-style-type: none"> – Parameter Function of the logic gate \ Option <i>Threshold</i> – Parameter Enable Group Objects "Status Result" and "Status Input value between thresholds" \ Option <i>Yes</i> 				
Change lower threshold	Logic/Threshold X: Threshold	DPT 13.010	4 bytes	C W
This Group Object is used to receive, via the bus (ABB i-bus® KNX), a new value for the lower threshold. The data point type for the Group Object depends on the option selected in the parameter Data point type of Group Object "Threshold input" . Telegram value:				
<ul style="list-style-type: none"> • 0 ... 2147483647 Wh 				
Prerequisites for visibility				
<ul style="list-style-type: none"> • Parameter window Configuration \ Parameter Enable Logic/Threshold x-y \ Option <i>Yes</i> • Parameter window Logic/Threshold \ Parameter window Logic/Threshold x <ul style="list-style-type: none"> – Parameter Function of the logic gate \ Option <i>Threshold</i> – Parameter Data point type of Group Object "Threshold input" \ Option <i>Wh (DPT 13.010)</i> – Parameter Change thresholds via Group Objects \ Option <i>Yes</i> 				
Change lower threshold	Logic/Threshold X: Threshold	DPT 13.013	4 bytes	C W
This Group Object is used to receive, via the bus (ABB i-bus® KNX), a new value for the lower threshold. The data point type for the Group Object depends on the option selected in the parameter Data point type of Group Object "Threshold input" . Telegram value:				
<ul style="list-style-type: none"> • 0 ... 2147483647 kWh 				
Prerequisites for visibility				
<ul style="list-style-type: none"> • Parameter window Configuration \ Parameter Enable Logic/Threshold x-y \ Option <i>Yes</i> • Parameter window Logic/Threshold \ Parameter window Logic/Threshold x <ul style="list-style-type: none"> – Parameter Function of the logic gate \ Option <i>Threshold</i> – Parameter Data point type of Group Object "Threshold input" \ Option <i>kWh (DPT 13.013)</i> – Parameter Change thresholds via Group Objects \ Option <i>Yes</i> 				
Change lower threshold	Logic/Threshold X: Threshold	DPT 14.019	4 bytes	C W
This Group Object is used to receive, via the bus (ABB i-bus® KNX), a new value for the lower threshold. The data point type for the Group Object depends on the option selected in the parameter Data point type of Group Object "Threshold input" . Telegram value:				
<ul style="list-style-type: none"> • 0 ... 24 A 				
Prerequisites for visibility				
<ul style="list-style-type: none"> • Parameter window Configuration \ Parameter Enable Logic/Threshold x-y \ Option <i>Yes</i> • Parameter window Logic/Threshold \ Parameter window Logic/Threshold x <ul style="list-style-type: none"> – Parameter Function of the logic gate \ Option <i>Threshold</i> – Parameter Data point type of Group Object "Threshold input" \ Option <i>A (DPT 14.019)</i> – Parameter Change thresholds via Group Objects \ Option <i>Yes</i> 				

Function	Group Object name	Data point type	Length	Flags
Change lower threshold	Logic/Threshold X: Threshold	DPT 14.056	4 bytes	C W
<p>This Group Object is used to receive, via the bus (ABB i-bus® KNX), a new value for the lower threshold. The data point type for the Group Object depends on the option selected in the parameter Data point type of Group Object "Threshold input". Telegram value:</p> <ul style="list-style-type: none"> 0 ... 10000 W <p>Prerequisites for visibility</p> <ul style="list-style-type: none"> Parameter window Configuration \ Parameter Enable Logic/Threshold x-y \ Option Yes Parameter window Logic/Threshold \ Parameter window Logic/Threshold x <ul style="list-style-type: none"> Parameter Function of the logic gate \ Option Threshold Parameter Data point type of Group Object "Threshold input" \ Option W (DPT 14.056) Parameter Change thresholds via Group Objects \ Option Yes 				
Change lower threshold	Logic/Threshold X: Threshold	DPT 5.001	1 byte	C W
<p>This Group Object is used to receive, via the bus (ABB i-bus® KNX), a new value for the lower threshold. The data point type for the Group Object depends on the option selected in the parameter Data point type of Group Object "Threshold input". Telegram value:</p> <ul style="list-style-type: none"> 0 ... 100 % <p>Prerequisites for visibility</p> <ul style="list-style-type: none"> Parameter window Configuration \ Parameter Enable Logic/Threshold x-y \ Option Yes Parameter window Logic/Threshold \ Parameter window Logic/Threshold x <ul style="list-style-type: none"> Parameter Function of the logic gate \ Option Threshold Parameter Data point type of Group Object "Threshold input" \ Option Percent (DPT 5.001) Parameter Change thresholds via Group Objects \ Option Yes 				
Change lower threshold	Logic/Threshold X: Threshold	DPT 5.010	1 byte	C W
<p>This Group Object is used to receive, via the bus (ABB i-bus® KNX), a new value for the lower threshold. The data point type for the Group Object depends on the option selected in the parameter Data point type of Group Object "Threshold input". Telegram value:</p> <ul style="list-style-type: none"> 0 ... 255 <p>Prerequisites for visibility</p> <ul style="list-style-type: none"> Parameter window Configuration \ Parameter Enable Logic/Threshold x-y \ Option Yes Parameter window Logic/Threshold \ Parameter window Logic/Threshold x <ul style="list-style-type: none"> Parameter Function of the logic gate \ Option Threshold Parameter Data point type of Group Object "Threshold input" \ Option Meter pulses (DPT 5.010) Parameter Change thresholds via Group Objects \ Option Yes 				
Change lower threshold	Logic/Threshold X: Threshold	DPT 7.001	2 bytes	C W
<p>This Group Object is used to receive, via the bus (ABB i-bus® KNX), a new value for the lower threshold. The data point type for the Group Object depends on the option selected in the parameter Data point type of Group Object "Threshold input". Telegram value:</p> <ul style="list-style-type: none"> 0 ... 65535 <p>Prerequisites for visibility</p> <ul style="list-style-type: none"> Parameter window Configuration \ Parameter Enable Logic/Threshold x-y \ Option Yes Parameter window Logic/Threshold \ Parameter window Logic/Threshold x <ul style="list-style-type: none"> Parameter Function of the logic gate \ Option Threshold Parameter Data point type of Group Object "Threshold input" \ Option Meter pulses (DPT 7.001) Parameter Change thresholds via Group Objects \ Option Yes 				
Change lower threshold	Logic/Threshold X: Threshold	DPT 9.001	2 bytes	C W
<p>This Group Object is used to receive, via the bus (ABB i-bus® KNX), a new value for the lower threshold. The data point type for the Group Object depends on the option selected in the parameter Data point type of Group Object "Threshold input". Telegram value:</p> <ul style="list-style-type: none"> -273 ... 670760 °C <p>Prerequisites for visibility</p> <ul style="list-style-type: none"> Parameter window Configuration \ Parameter Enable Logic/Threshold x-y \ Option Yes Parameter window Logic/Threshold \ Parameter window Logic/Threshold x <ul style="list-style-type: none"> Parameter Function of the logic gate \ Option Threshold Parameter Data point type of Group Object "Threshold input" \ Option Temperature (DPT 9.001) Parameter Change thresholds via Group Objects \ Option Yes 				
Change lower threshold	Logic/Threshold X: Threshold	DPT 9.004	2 bytes	C W
<p>This Group Object is used to receive, via the bus (ABB i-bus® KNX), a new value for the lower threshold. The data point type for the Group Object depends on the option selected in the parameter Data point type of Group Object "Threshold input". Telegram value:</p> <ul style="list-style-type: none"> 0 ... 670760 lux <p>Prerequisites for visibility</p> <ul style="list-style-type: none"> Parameter window Configuration \ Parameter Enable Logic/Threshold x-y \ Option Yes Parameter window Logic/Threshold \ Parameter window Logic/Threshold x <ul style="list-style-type: none"> Parameter Function of the logic gate \ Option Threshold Parameter Data point type of Group Object "Threshold input" \ Option Lux (DPT 9.004) Parameter Change thresholds via Group Objects \ Option Yes 				

Function	Group Object name	Data point type	Length	Flags
Change lower threshold	Logic/Threshold X: Threshold	DPT 9.021	2 bytes	C W
This Group Object is used to receive, via the bus (ABB i-bus® KNX), a new value for the lower threshold. The data point type for the Group Object depends on the option selected in the parameter Data point type of Group Object "Threshold input" . Telegram value: <ul style="list-style-type: none"> 0 ... 240000 mA Prerequisites for visibility <ul style="list-style-type: none"> Parameter window Configuration \ Parameter Enable Logic/Threshold x-y \ Option <i>Yes</i> Parameter window Logic/Threshold \ Parameter window Logic/Threshold x <ul style="list-style-type: none"> Parameter Function of the logic gate \ Option <i>Threshold</i> Parameter Data point type of Group Object "Threshold input" \ Option <i>mA (DPT 9.021)</i> Parameter Change thresholds via Group Objects \ Option <i>Yes</i> 				
Change lower threshold	Logic/Threshold X: Threshold	DPT 9.024	2 bytes	C W
This Group Object is used to receive, via the bus (ABB i-bus® KNX), a new value for the lower threshold. The data point type for the Group Object depends on the option selected in the parameter Data point type of Group Object "Threshold input" . Telegram value: <ul style="list-style-type: none"> 0 ... 10 kW Prerequisites for visibility <ul style="list-style-type: none"> Parameter window Configuration \ Parameter Enable Logic/Threshold x-y \ Option <i>Yes</i> Parameter window Logic/Threshold \ Parameter window Logic/Threshold x <ul style="list-style-type: none"> Parameter Function of the logic gate \ Option <i>Threshold</i> Parameter Data point type of Group Object "Threshold input" \ Option <i>kW (DPT 9.024)</i> Parameter Change thresholds via Group Objects \ Option <i>Yes</i> 				
Connection A	Logic/Threshold X: Logic	DPT 1.002	1 bit	C W
This Group Object is used to receive, via the bus (ABB i-bus® KNX), an input value for the function <i>Logic</i> . More information: → Function Logic, Page 42 . Telegram value: <ul style="list-style-type: none"> 1 = Logically true 0 = Logically false 				
<p>Note</p> It is necessary to select in the parameter Read input Group Objects after bus voltage recovery and download the option <i>Yes</i> to update automatically the Group Object. <p>Note</p> To update the input Group Objects after bus voltage recovery or download, the read flags must be set for the corresponding Group Objects of the sending device. Prerequisites for visibility <ul style="list-style-type: none"> Parameter window Configuration \ Parameter Enable Logic/Threshold x-y \ Option <i>Yes</i> Parameter window Logic/Threshold \ Parameter window Logic/Threshold x \ Parameter Function of the logic gate \ Option <i>AND / OR / Exclusive OR / GATE / 1 bit Inverter</i> 				
Connection B	Logic/Threshold X: Logic	DPT 1.002	1 bit	C W
This Group Object is used to receive, via the bus (ABB i-bus® KNX), an input value for the function <i>Logic</i> . More information: → Function Logic, Page 42 . Telegram value: <ul style="list-style-type: none"> 1 = Logically true 0 = Logically false 				
<p>Note</p> It is necessary to select in the parameter Read input Group Objects after bus voltage recovery and download the option <i>Yes</i> to update automatically the Group Object. <p>Note</p> To update the input Group Objects after bus voltage recovery or download, the read flags must be set for the corresponding Group Objects of the sending device. Prerequisites for visibility <ul style="list-style-type: none"> Parameter window Configuration \ Parameter Enable Logic/Threshold x-y \ Option <i>Yes</i> Parameter window Logic/Threshold \ Parameter window Logic/Threshold x \ Parameter Function of the logic gate \ Option <i>AND / OR / Exclusive OR / GATE</i> 				

8.5 Group Objects "Channel X": Switch

Function	Group Object name	Data point type	Length	Flags
Flashing	Channel X: Switch	DPT 1.001	1 bit	C W
This Group Object is used to start/stop, via the bus (ABB i-bus® KNX), the flashing. More information: → Function Flashing, Page 55 . Telegram value: <ul style="list-style-type: none"> Depends on the setting in the parameter Flashing if Group Object "Flashing" is 				
<p>Note</p> The relays can perform only a limited number of switching operations per minute. Frequent switching can cause a switching delay. More information → Technical data . Prerequisites for visibility <ul style="list-style-type: none"> Parameter window Configuration \ Parameter Enable output X \ Option <i>Yes</i> Parameter window Switch Actuator X \ Parameter window Functions Switch Actuator \ Parameter Enable function Time \ Option <i>Flashing</i> 				

Function	Group Object name	Data point type	Length	Flags
Block delay for switching on and off	Channel X: Switch	DPT 1.003	1 bit	C W

This Group Object is used to enable or block, via the bus (ABB i-bus® KNX), the function *Delay for switching on and off*.

Telegram value:

- 1 = Block function *Delay for switching on and off*
- 0 = Enable function *Delay for switching on and off*

Note

If a delay was set in a Scene assignment in the parameter *Delay*, this Group Object is also used to block the delay of the execution of the Scene.

Prerequisites for visibility

- Parameter window *Configuration* \ Parameter *Enable output X* \ Option *Yes*
- Parameter window *Switch Actuator X* \ Parameter window *Functions Switch Actuator* \ Parameter *Enable function Time* \ Option *Delay for switching on and off*
- Parameter window *Switch Actuator X* \ Parameter window *Delay for switching on and off*
 - Parameter *Parameter setting* \ Option *Individual*
 - Parameter *Block delay for switching on and off via Group Object* \ Option *Yes*

Switch	Channel X: Switch	DPT 1.001	1 bit	C W
--------	-------------------	-----------	-------	-----

This Group Object is used to receive a switch telegram via the bus (ABB i-bus® KNX).

The switching behavior depends on the setting in the parameter *Reaction of output*.

NO contact telegram value:

- 1 = Close relay contact
- 0 = Open relay contact

NC contact telegram value:

- 1 = Open relay contact
- 0 = Close relay contact

Note

Due to the priorities, a switching command does not necessarily change the position of the relay contact.

Each relay can perform only a limited number of switching operations per minute. Frequent switching can cause a switching delay. More information → Technical data.

Prerequisites for visibility

- Parameter window *Configuration* \ Parameter *Enable output X* \ Option *Yes*

Block	Channel X: Switch	DPT 1.003	1 bit	C W
-------	-------------------	-----------	-------	-----

This Group Object is used to Activate/Deactivate the safety function *Block*.

More information: → [Block, Page 41](#).

Telegram value:

- 1 = Activate block
- 0 = Deactivate block

Note

The safety function can also be activated/deactivated via i-bus® Tool.

Prerequisites for visibility

- Parameter window *Configuration* \ Parameter *Enable output X* \ Option *Yes*
- Parameter window *Switch Actuator X* \ Parameter window *Functions Switch Actuator* \ Parameter *Enable function Safety* \ Option *Yes*
- Parameter window *Switch Actuator X* \ Parameter window *Safety*
 - Parameter *Parameter setting* \ Option *Individual*
 - Parameter *Switching reaction on block* \ Option *On / Off / Unchanged (block)*

Status Switch	Channel X: Switch	DPT 1.011	1 bit	C R T
---------------	-------------------	-----------	-------	-------

This Group Object sends the position of the relay contact on the bus (ABB i-bus® KNX).

The send behavior depends on the setting in the parameter *Send value of Group Object "Status Switch"*.

Telegram value:

- Depends on the setting in the parameter *Value of Group Object "Status Switch"*

Prerequisites for visibility

- Parameter window *Configuration* \ Parameter *Enable output X* \ Option *Yes*
- Parameter window *Switch Actuator X* \ Parameter window *Basic settings [Switch Actuator]*
 - Parameter *Parameter setting* \ Option *Individual*
 - Parameter *Feedback of contact position via Group Object "Status Switch"* \ Option *Yes*

Function	Group Object name	Data point type	Length	Flags
Status byte all active priorities	Channel X: Switch	nonDPT	1 byte	C R T

This Group Object sends the status of all active priorities on the bus (ABB i-bus® KNX).

The send behavior depends on the setting in the parameter [Send value of Group Objects "Status byte" \[Switch Actuator\]](#).

Telegram value:

- Bit 0: not used
 - Telegram value is always 0
- Bit 1: Block
 - 1 = Active
 - 0 = Inactive
- Bit 2: forced operation
 - 1 = Active
 - 0 = Inactive
- Bit 3: Safety priority 1
 - 1 = Active
 - 0 = Inactive
- Bit 4: Safety priority 2
 - 1 = Active
 - 0 = Inactive
- Bit 5: Safety priority 3
 - 1 = Active
 - 0 = Inactive
- Bit 6: Load shedding
 - 1 = Active
 - 0 = Inactive
- Bit 7: i-bus® Tool
 - 1 = Active
 - 0 = Inactive

More information: → [Table of values, Group Object "Status byte all active priorities", Page 153.](#)

Prerequisites for visibility

- Parameter window [Configuration](#) \ Parameter [Enable output X](#) \ Option Yes
- Parameter window [Switch Actuator X](#) \ Parameter window [Basic settings \[Switch Actuator\]](#)
 - Parameter [Parameter setting](#) \ Option *Individual*
 - Parameter [Enable Group Objects "Status byte" \[Switch Actuator\]](#) \ Option *Yes, all active priorities*

Status byte highest active priority	Channel X: Switch	nonDPT	1 byte	C R T
-------------------------------------	-------------------	--------	--------	-------

This Group Object sends the status of the highest active priority on the bus (ABB i-bus® KNX).

The send behavior depends on the setting in the parameter [Send value of Group Objects "Status byte" \[Switch Actuator\]](#).

Telegram value:

- 0: No priority active (operating mode *KNX operation*)
- 1: Not used
- 2: Block active
- 3: Forced operation active
- 4: Safety priority 1 active
- 5: Safety priority 2 active
- 6: Safety priority 3 active
- 7: Load shedding active
- 8: i-bus® Tool active
- 9: Staircase lighting permanent on active
- 10: Flashing active
- 11 ... 255: Not used

Prerequisites for visibility

- Parameter window [Configuration](#) \ Parameter [Enable output X](#) \ Option Yes
- Parameter window [Switch Actuator X](#) \ Parameter window [Basic settings \[Switch Actuator\]](#)
 - Parameter [Parameter setting](#) \ Option *Individual*
 - Parameter [Enable Group Objects "Status byte" \[Switch Actuator\]](#) \ Option *Yes, highest active priority*

Scene 1...64	Channel X: Switch	DPT 18.001	1 byte	C W
--------------	-------------------	------------	--------	-----

This Group Object is used to receive, via the bus (ABB i-bus® KNX), a Scene telegram.

The Scene telegram includes the Scene number and information about whether the Scene is recalled or the position of the relay contact is saved in the Scene.

A Scene number is assigned in the parameter window [Scene assignments \[Switch Actuator\]](#). If the corresponding Scene number is parametrized for an output, the Scene is recalled or saved, depending on the telegram value.

Telegram value:

- 0 ... 63 = Recall Scene x (x = 1 ... 64)
- 128 ... 191 = Save Scene x (x = 1 ... 64)

For more information, see:

- [Function Scenes, Page 50](#)
- [Function diagram Switch Actuator, Page 40](#)
- [Table of values, Group Object "Scene 1 ... 64", Page 155](#)



Note

A telegram does not necessarily result in a change to the position of the relay contact due to the priorities.

Prerequisites for visibility

- Parameter window [Configuration](#) \ Parameter [Enable output X](#) \ Option Yes
- Parameter window [Switch Actuator X](#) \ Parameter window [Functions Switch Actuator](#) \ Parameter [Enable function Scenes \[Switch Actuator\]](#) \ Option Yes

Function	Group Object name	Data point type	Length	Flags
Recall Scene assignment x	Channel X: Switch	DPT 1.017	1 bit	C W
<p>This Group Object is used to receive, via the bus (ABB i-bus® KNX), a Scene assignment. Telegram value:</p> <ul style="list-style-type: none"> • 1 = Recall scene assignment x (x = 1 ... 4) • 0 = Recall Scene assignment x (x = 1 ... 4) <p>Prerequisites for visibility</p> <ul style="list-style-type: none"> • Parameter window Configuration \ Parameter Enable output X \ Option <i>Yes</i> • Parameter window Switch Actuator X \ Parameter window Functions Switch Actuator \ Parameter Enable function Scenes [Switch Actuator] \ Option <i>Yes</i> • Parameter window Switch Actuator X \ Parameter window Scene assignments [Switch Actuator] <ul style="list-style-type: none"> – Parameter Parameter setting \ Option <i>Individual</i> – Parameter Enable Scene assignment x [Switch Actuator] \ Option <i>Yes</i> – Parameter Recall Scene x also via 1-bit Group Object \ Option <i>Yes</i> 				
Staircase lighting permanent on	Channel X: Switch	DPT 1.001	1 bit	C W
<p>This Group Object is used to receive, via the bus (ABB i-bus® KNX), the command to start/stop permanent on operation. If the function <i>Staircase lighting</i> is active, the output can be permanently switched on via this Group Object. Other functions continue to run in the background, but they do not trigger any switching action. Telegram value:</p> <ul style="list-style-type: none"> • 1 = Start permanent on operation • 0 = End permanent on operation <p>Prerequisites for visibility</p> <ul style="list-style-type: none"> • Parameter window Configuration \ Parameter Enable output X \ Option <i>Yes</i> • Parameter window Switch Actuator X \ Parameter window Functions Switch Actuator \ Parameter Enable function Time \ Option <i>Staircase lighting</i> 				
Warning staircase lighting	Channel X: Switch	DPT 1.001	1 bit	C R T
<p>This Group Object sends a pre-warning on the bus (ABB i-bus® KNX) before switching off the output. More information: → Function Staircase lighting, Page 52. Telegram value:</p> <ul style="list-style-type: none"> • 1 = Warning staircase lighting active • 0 = Warning staircase lighting inactive <p>Prerequisites for visibility</p> <ul style="list-style-type: none"> • Parameter window Configuration \ Parameter Enable output X \ Option <i>Yes</i> • Parameter window Switch Actuator X \ Parameter window Functions Switch Actuator \ Parameter Enable function Time \ Option <i>Staircase lighting</i> • Parameter window Switch Actuator X \ Parameter window Staircase lighting <ul style="list-style-type: none"> – Parameter Parameter setting \ Option <i>Individual</i> – Parameter Warning before switching off the staircase lighting \ Options <i>Via Group Object / Via Group Object and short switching off</i> 				
Block staircase lighting	Channel X: Switch	DPT 1.003	1 bit	C W
<p>This Group Object is used to enable or block, via the bus (ABB i-bus® KNX), the function <i>Staircase lighting</i>. Telegram value:</p> <ul style="list-style-type: none"> • 1 = Block function <i>Staircase lighting</i> • 0 = Enable function <i>Staircase lighting</i> <p>Prerequisites for visibility</p> <ul style="list-style-type: none"> • Parameter window Configuration \ Parameter Enable output X \ Option <i>Yes</i> • Parameter window Switch Actuator X \ Parameter window Functions Switch Actuator \ Parameter Enable function Time \ Option <i>Staircase lighting</i> • Parameter window Switch Actuator X \ Parameter window Staircase lighting <ul style="list-style-type: none"> – Parameter Parameter setting \ Option <i>Individual</i> – Parameter Block staircase lighting via Group Object \ Option <i>Yes</i> 				
Staircase lighting time	Channel X: Switch	DPT 7.005	2 bytes	C W
<p>This Group Object is used to receive, via the bus (ABB i-bus® KNX), the duration of the staircase lighting time. Telegram value:</p> <ul style="list-style-type: none"> • 0 ... 65,535 s <p>Prerequisites for visibility</p> <ul style="list-style-type: none"> • Parameter window Configuration \ Parameter Enable output X \ Option <i>Yes</i> • Parameter window Switch Actuator X \ Parameter window Functions Switch Actuator \ Parameter Enable function Time \ Option <i>Staircase lighting</i> • Parameter window Switch Actuator X \ Parameter window Staircase lighting <ul style="list-style-type: none"> – Parameter Parameter setting \ Option <i>Individual</i> – Parameter Change staircase lighting time via Group Object \ Option <i>Yes</i> 				
Forced operation, 1-bit	Channel X: Switch	DPT 1.003	1 bit	C W
<p>This Group Object is used to Activate/Deactivate 1-bit forced operation via the bus (ABB i-bus® KNX). For more information, see: → forced operation, Page 42. Telegram value:</p> <ul style="list-style-type: none"> • Depends on the setting in the parameter Forced operation (1 bit / 2 bit) [Switch Actuator] <p>Prerequisites for visibility</p> <ul style="list-style-type: none"> • Parameter window Configuration \ Parameter Enable output X \ Option <i>Yes</i> • Parameter window Switch Actuator X \ Parameter window Functions Switch Actuator \ Parameter Enable function Safety \ Option <i>Yes</i> • Parameter window Switch Actuator X \ Parameter window Safety <ul style="list-style-type: none"> – Parameter Parameter setting \ Option <i>Individual</i> – Parameter Forced operation (1 bit / 2 bit) [Switch Actuator] \ Options <i>Activated 1 bit – 0 active / Activated 1 bit – 1 active</i> 				

Function	Group Object name	Data point type	Length	Flags
Forced operation, 2-bit	Channel X: Switch	DPT 2.001	2 bit	C W

This Group Object is used to Activate/Deactivate 2-bit forced operation via the bus (ABB i-bus® KNX).
For more information, see: → [forced operation, Page 42](#).

Telegram value (bit 1 | bit 0):

- 0 | 0 = Forced operation inactive
- 0 | 1 = Forced operation inactive
- 1 | 0 = Forced operation active "OFF"
- 1 | 1 = Forced operation active "ON"

Prerequisites for visibility

- Parameter window [Configuration](#) \ Parameter [Enable output X](#) \ Option *Yes*
- Parameter window [Switch Actuator X](#) \ Parameter window [Functions Switch Actuator](#) \ Parameter [Enable function Safety](#) \ Option *Yes*
- Parameter window [Switch Actuator X](#) \ Parameter window [Safety](#)
 - Parameter [Parameter setting](#) \ Option *Individual*
 - Parameter [Forced operation \(1 bit / 2 bit\) \[Switch Actuator\]](#) \ Option *Activated 2 bit*

8.6 Group Objects "Channel X": Load shedding

Function	Group Object name	Data point type	Length	Flags
Set load shedding stage	Channel X: Load shedding	DPT 236.001	1 byte	C W

This Group Object is used to receive, via the bus (ABB i-bus® KNX), the load shedding stage for the channel.
More information: → [Function Load shedding, Page 45](#).

Telegram value:

- → [Coding, Group Object "Set load shedding stage", Page 149](#)

Prerequisites for visibility

- Parameter window [Configuration](#) \ Parameter [Enable output X](#) \ Option *Yes*
- Parameter window [Device settings](#) \ Parameter [Enable central Group Object "Receive load shedding stage"](#) \ Option *Yes*
- Parameter window [Switch Actuator X](#) \ Parameter window [Functions Switch Actuator](#) \ Parameter [Enable function Load shedding](#) \ Option *Yes*
- Parameter window [Switch Actuator X](#) \ Parameter window [Load shedding](#)
 - Parameter [Parameter setting](#) \ Option *Individual*
 - Parameter [Change load shedding stage via Group Object](#) \ Option *Yes*

Status Load shedding	Channel X: Load shedding	DPT 1.011	1 bit	C R T
-----------------------------	---------------------------------	------------------	--------------	--------------

This Group Object sends the status of the load shedding on the bus (ABB i-bus® KNX).
The send behavior depends on the setting in the parameter [Send value of Group Object "Status Load shedding"](#).

Telegram value:

- 1 = Load shedding active
- 0 = Load shedding inactive

Prerequisites for visibility

- Parameter window [Configuration](#) \ Parameter [Enable output X](#) \ Option *Yes*
- Parameter window [Device settings](#) \ Parameter [Enable central Group Object "Receive load shedding stage"](#) \ Option *Yes*
- Parameter window [Switch Actuator X](#) \ Parameter window [Functions Switch Actuator](#) \ Parameter [Enable function Load shedding](#) \ Option *Yes*
- Parameter window [Switch Actuator X](#) \ Parameter window [Load shedding](#)
 - Parameter [Parameter setting](#) \ Option *Individual*
 - Parameter [Enable group object "Status Load shedding"](#) \ Option *Yes*

9 Operation

9.1 Manual operation

The relays for the outputs can be switched On (I) and Off (O) manually using the toggle switches. The relays can also be switched if there is a bus voltage failure and by active safety functions.



DANGER – Accidents due to unexpected reaction of the devices connected

If the relays are switched, devices further away or idle devices may react unexpectedly.

Before the toggle switches are operated:

- ▶ Identify locations and areas of action of the devices connected
- ▶ Tell persons to leave possible hazardous zones and cordon off hazardous zones.

i Note

If the relays are switched manually using the toggle switches, KNX operation is overridden. Manually set contact positions are not detected by the device and are not set again automatically after bus voltage recovery or after ETS download.

10 Maintenance and cleaning

10.1 Maintenance

The device is maintenance-free if used properly. In the event of damage, e.g. during transport and/or storage, repairs are not allowed to be made.

10.2 Cleaning

1. Disconnect the device from the electrical power supply before cleaning.
2. Clean dirty devices using a dry cloth or a slightly damp cloth.

11 Removal and disposal

11.1 Removal

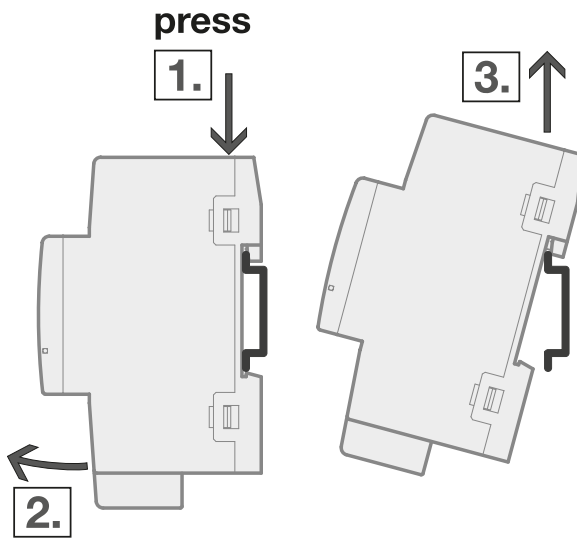

Fig. 34: Removing from the mounting rail

1. Press on the top of the device.
2. Release the bottom of the device from the mounting rail.
3. Lift the device up and off the mounting rail.

11.2 Environment

Consider environmental protection.

Electrical and electronic devices must not be disposed of as domestic waste.



The device contains valuable resources that can be recycled. Therefore, please take the device to a suitable recycling center. All packaging materials and devices are provided with markings and test seals for proper disposal. Always dispose of packaging material and electrical devices or their components at collection points or disposal companies authorized for this purpose. The products comply with the statutory requirements, particularly the law on electrical and electronic equipment and the REACH regulation. (EU directive 2012/19/EU WEEE and 2011/65/EU RoHS) (EU REACH regulation and the law implementing the regulation (EC) no.1907/2006)

12 Planning and application

12.1 Priorities

12.1.1 Priorities for Switch Actuator

- a) Manual operation via toggle switches
- b) Safety functions:
 - Safety priority 1 (device)
 - Forced operation (output)
 - Safety priority 2 (device)
 - Safety priority 3 (device)
 - Block (output)
- c) Bus voltage failure
- d) i-bus® Tool
- e) Load shedding
- f) Operating mode *KNX operation*
- g) Bus voltage recovery

More information: → [Function diagram Switch Actuator, Page 40.](#)

i Note

The interface to i-bus® Tool is available from the following software versions:

- Application from V1.2
- Firmware from V0.2.0

12.2 Basic knowledge

12.2.1 AC-1, AC-3, AC-5, AX and C load

In Intelligent Building Control, different switching capacities and performance specifications required by special applications have become established for the industrial area and for building control. These performance specifications are rooted in the respective national and international standards. The tests are defined to simulate typical applications, e.g. motor loads (industrial) or fluorescent lamps (residential).

Industrial area

Specifications AC-1 and AC-3 are switching capacity specifications that have become established in the industrial field. These switching capacities are defined in the standard EN IEC 60947-4-1 "Low-voltage switchgear and controlgear – Part 4-1: Contactors and motor-starters – Electromechanical contactors and motor-starters". The standard describes starters and/or contactors that are used mainly in industrial applications.

Typical applications:

- AC-1 – non-inductive or slightly inductive load, resistance furnaces (relates to switching of ohmic loads, $\cos \varphi = 0.8$)
- AC-3 – squirrel-cage motors: starting, switching off motors during running (relates to (inductive) motor load, $\cos \varphi = 0.45$)
- AC-5a – switching of electric discharge lamps

Building control

The AX designation has come into use in the field of building control. AX refers to a (capacitive) fluorescent lighting load. The term "switchable capacitive loads" (200 μF , 140 μF , 70 μF or 35 μF) is used in connection with fluorescent lighting loads. These switching capacities are defined in the standard EN 60669 "Switches for household and similar fixed electrical installations". The standard describes switches that are used mainly in industrial applications. Testing with 70 μF is required for devices with a rated current of 6 A, testing with 140 μF for devices with a rated current > 6 A.

Comparison of AC and AX

The switching capacity specifications AC and AX are not directly comparable with each other. The following switching capacity qualities can be identified:

- Low switching capacity: AC-1 – primarily resistive loads
- Medium switching capacity: AX - fluorescent lighting loads according to EN 60669: 70 μF (6 A), 140 μF (10 A, 16 A)
- High switching capacity:
 - AC-3 - motor loads
 - C load - fluorescent lighting loads (200 μF)

The specifications AC-3 and AX are almost equivalent. A device that passed the test for AC3 according to DIN 60947 will very likely also pass the tests according to EN 60669 with 200 μF .

In summary the following can be stated:

- In the industrial area, the common designation is "AC-3 load".
- In building control, the common designation is "AX load" or "C load".

The switching capacity differences must be taken into account while selecting a Switch Actuator.

12.2.2

Coding, Group Object "Receive load shedding stage"

The information in the Group Object *Receive load shedding stage* is coded as follows:

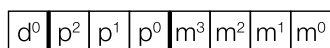

Fig. 35: Coding, data point type 236.001

The bit fields d and p contain information for the central load control.

Bit d⁰ activates or deactivates the central load control priority:

- 1 = Central load control priority is not active
- 0 = Central load control priority is active

The bits p² to p⁰ contain the central load control priorities. The bits must be set to 000, because the device only supports this priority.

The bits m³ to m⁰ contain the number of the load shedding stage (1 ... 15).

This produces the following coding:

- 1000mmmm or 00000000 = Load shedding stage not active
- 00000001 = Load shedding stage 1 (lowest priority)
- ...
- 00001111 = Load shedding stage 15 (highest priority)

All other values are not evaluated and discarded.

12.2.3 Coding, Group Object "Set load shedding stage"

The information in the Group Object *Set load shedding stage* is coded as follows:

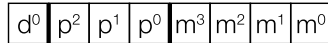

Fig. 36: Coding, data point type 236.001

The bit fields d and p contain information for the central load control. This information is not relevant for the device, the bits must be set to 0000.

The bits m³ to m⁰ contain the number of the load shedding stage (1 ... 15).

This produces the following coding:

- 00000001 = Set load shedding stage 1
- ...
- 00001111 = Set load shedding stage 15

All other values are not evaluated and discarded.

12.2.4 Ballast calculation

A ballast is used to operate gas-discharge lamps, e.g. fluorescent lamps. A ballast converts the mains voltage to the optimal operating voltage for the lamp and allows the lamp to strike (switch on). With the choke starter circuit, the lamps strike with a time offset, with the ballast circuit the lamps strike almost simultaneously.

For LED lamps the ballast is termed the LED driver or LED converter. The LED driver provides constant direct current or smoothed direct current for operating the lamps connected.

Input capacitors in the ballast's electronic circuit are required for storing charge to rectify and stabilize the alternating voltage or current on the primary side. The input capacitors charge at the moment of switch-on. The charging of the capacitors briefly generates a very high inrush current I_{peak} . If several ballasts are used in the same circuit, simultaneous charging of the capacitors can cause very high inrush currents to flow. The individual inrush currents must be taken into account in the design of the switching contacts and the selection of the back-up fuse. The inrush current is dependent on the ballast power, types and number of elements.

To determine the maximum number of ballasts that can be connected per output, the inrush current I_{peak} and the associated pulse width of the ballast must be known → Technical data for the ballast.

Typical values for the inrush current I_{peak} :

- Single-element ballast with T5/T8 fluorescent lamps: 15 ... 50 A, pulse time 120 ... 200 μs
- LED driver: 3 ... 50 A, pulse time 40 ... 250 μs

Refer to the related device's technical data for the maximum inrush current I_{peak} of the switching outputs → [Product overview, Page 9](#).

Example

Sample calculation for determining the maximum number of ballasts that can be connected per output:

- Ballast: ABB i-bus® KNX Ballast 1 x 58 CF, inrush current $I_{\text{peak}} = 33.9 \text{ A}$ (147.1 μs)
- Maximum permissible inrush current I_{peak} of the output = 200 A (150 μs)
- Calculation: $200 \text{ A} / 33.9 \text{ A} = 5.89$

Result: Five ballasts can be connected per output.

12.2.5 Refreshed KNX state

If an input or an output is blocked by device-specific functions (e.g. manual operation, alarms, block, forced operation, switching delay), it will not react to telegrams received via the bus (ABB i-bus® KNX) while the block is active.

While a block is active, the device processes the telegrams received in the background. Active functions (e.g. staircase lighting, logic, position, brightness value) are executed in the background, but the results are not sent. The actual value is sent to the input or output when the block is canceled.

If the input or output has not received any telegrams via the bus (ABB i-bus® KNX) while a block is active, the input or output will assume the state it was in before the block.

12.2.6 Sending and switching delay

No telegrams are sent on the bus during the sending and switching delay (ABB i-bus® KNX).

Telegrams received (e.g. requests from a visualization system) are sent to the outputs after the sending and switching delay expires. The state of the outputs is set according to the settings in the ETS application or the telegram values of the Group Objects.

Time sequences (e.g. staircase lighting time) are started immediately during the sending and switching delay. If, at the time of reception, the staircase lighting time is smaller than the remaining sending and switching delay, the staircase lighting time elapses during the sending and switching delay. After the sending and switching delay has elapsed there is no switching command, the staircase lighting is not switched on.

Example

The delay time avoids unnecessary relay switching operations.

If an Off telegram is received during the sending and switching delay, the On telegram is overwritten and the relay is not switched.

Note

The sending and switching delay includes the device initialization time.

12.2.7 Telegram rate limit

The bus load generated by the device can be limited using the telegram rate limit. This limit relates to all telegrams sent by the device.

The device counts the number of telegrams sent within the parameterized period. As soon as the maximum number of sent telegrams is reached, no further telegrams are sent on the bus (ABB i-bus® KNX) until the end of the period. A new period commences automatically at the end of the previous period. The telegram counter is reset to zero. Telegrams can be sent again. The Group Object always sends the current telegram value.

The first period (break time) is not precisely predefined. The break time can be anywhere between 0 seconds and the parameterized period. The subsequent periods correspond to the parameterized time → parameter *In period (0 = deactivated)*.

Example

- Number of telegrams = 20
- Maximum number of telegrams per period = 5
- Period = 5 s

The device immediately sends 5 telegrams. The next 5 telegrams are sent after a maximum of 5 seconds. From this point, a further 5 telegrams are sent via the bus (ABB i-bus® KNX) every 5 seconds.

12.2.8 Value Read

Using the command "Value Read" the value of the state of a group address in a Group Object can be read. A Group Object can only reply if the "Read" flag is set. The group address first in the Group Object (sending group address) is always sent. The reply is only sent once and can only be understood by the Group Object that triggered the "Value Read" command. The value received is written to the reading Group Object.

12.2.9 Central Group Objects

The central Group Objects of the device can be used to switch several device outputs at the same time.

The following Group Object is available for central control of the Switch Actuator outputs:

- *Switch*

i Note

In the parameter *Switch output reacts to central Switch Group Object*, it can be defined for each Switch Actuator output whether the output reacts to the central Group Object.

The following Group Object is available for central control of the Scenes:

- *Scene 1 ... 64*

12.2.10 Cyclical monitoring

The reception of a telegram on a Group Object can be monitored using the cyclical monitoring. If a telegram is not received on the Group Object within a parameterizable time (monitoring cycle), the sending device may be faulty or the bus cable to the sending device may be interrupted. The reaction to the loss of a telegram can be set in the application-specific parameters for the device.

After the receipt of a telegram, ETS download or bus voltage recovery, the monitoring cycle is restarted.

i Note

The monitoring cycle in the device should be at least quadruple the cyclical sending time of the sending device. As a result, the reactions set will not be triggered immediately if a signal is missing, e.g. due to high bus load.

13 Appendix

13.1 Scope of delivery

The device is supplied together with the following components:

- 1x Switch Actuator
- 1 x installation and operating instructions
- 1 x bus connection terminal (red/black)
- 1 x KNX connection cover cap

13.2 Table of values, Group Object "Status byte all active priorities"

The following code table contains the telegram code of the Group Object *Status byte all active priorities* for a switching output.

All active priorities that affect the switching of the output are indicated in the status byte.

x = Value 1

Empty = Value 0

Bit no.	7	6	5	4	3	2	1	0	
8-bit value	Hexadecimal	i-bus® Tool	Load shedding	Safety priority 3	Safety priority 2	Safety priority 1	forced operation	Block	Not used
0	00								
1	01								
2	02								
3	03							x	
4	04						x		
5	05						x		
6	06						x	x	
7	07						x	x	
8	08					x			
9	09					x			
10	0A					x		x	
11	0B					x		x	
12	0C					x	x		
13	0D					x	x		
14	0E					x	x	x	
15	0F					x	x	x	
16	10				x				
17	11				x				
18	12				x			x	
19	13				x			x	
20	14				x		x		
21	15				x		x		
22	16				x		x	x	
23	17				x		x	x	
24	18				x	x			
25	19				x	x			
26	1A				x	x		x	
27	1B				x	x		x	
28	1C				x	x	x		
29	1D				x	x	x		
30	1E				x	x	x	x	
31	1F				x	x	x	x	
32	20			x					
33	21			x					
34	22			x				x	
35	23			x				x	
36	24			x			x		
37	25			x			x		
38	26			x			x	x	
39	27			x			x	x	
40	28			x		x			
41	29			x		x			
42	2A			x		x		x	
43	2B			x		x		x	
44	2C			x		x	x		
45	2D			x		x	x		
46	2E			x		x	x	x	
47	2F			x		x	x	x	
48	30			x	x				
49	31			x	x				
50	32			x	x			x	
51	33			x	x			x	
52	34			x	x		x		
53	35			x	x		x		
54	36			x	x		x	x	
55	37			x	x		x	x	
56	38			x	x	x			
57	39			x	x	x			
58	3A			x	x	x		x	
59	3B			x	x	x		x	
60	3C			x	x	x	x		
61	3D			x	x	x	x		
62	3E			x	x	x	x	x	
63	3F			x	x	x	x	x	

Bit no.	7	6	5	4	3	2	1	0	
8-bit value	Hexadecimal	i-bus® Tool	Load shedding	Safety priority 3	Safety priority 2	Safety priority 1	forced operation	Block	Not used
64	40		x						
65	41		x						
66	42		x					x	
67	43		x					x	
68	44		x				x		
69	45		x				x		
70	46		x				x	x	
71	47		x				x	x	
72	48		x			x			
73	49		x			x			
74	4A		x			x		x	
75	4B		x			x		x	
76	4C		x			x	x		
77	4D		x			x	x		
78	4E		x			x	x	x	
79	4F		x			x	x	x	
80	50		x		x				
81	51		x		x				
82	52		x		x			x	
83	53		x		x			x	
84	54		x		x		x		
85	55		x		x		x		
86	56		x		x		x	x	
87	57		x		x		x	x	
88	58		x		x	x			
89	59		x		x	x			
90	5A		x		x	x		x	
91	5B		x		x	x		x	
92	5C		x		x	x	x		
93	5D		x		x	x	x		
94	5E		x		x	x	x	x	
95	5F		x		x	x	x	x	
96	60		x	x					
97	61		x	x					
98	62		x	x				x	
99	63		x	x				x	
100	64		x	x			x		
101	65		x	x			x		
102	66		x	x			x	x	
103	67		x	x			x	x	
104	68		x	x		x			
105	69		x	x		x			
106	6A		x	x		x		x	
107	6B		x	x		x		x	
108	6C		x	x		x	x		
109	6D		x	x		x	x		
110	6E		x	x		x	x	x	
111	6F		x	x		x	x	x	
112	70		x	x	x				
113	71		x	x	x				
114	72		x	x	x			x	
115	73		x	x	x			x	
116	74		x	x	x		x		
117	75		x	x	x		x		
118	76		x	x	x		x	x	
119	77		x	x	x		x	x	
120	78		x	x	x	x			
121	79		x	x	x	x			
122	7A		x	x	x	x		x	
123	7B		x	x	x	x		x	
124	7C		x	x	x	x	x		
125	7D		x	x	x	x	x		
126	7E		x	x	x	x	x	x	
127	7F		x	x	x	x	x	x	

Bit no.		7	6	5	4	3	2	1	0
8-bit value	Hexadecimal	i-bus® Tool	Load shedding	Safety priority 3	Safety priority 2	Safety priority 1	forced operation	Block	Not used
128	80	x							
129	81	x							
130	82	x						x	
131	83	x						x	
132	84	x					x		
133	85	x					x		
134	86	x					x	x	
135	87	x					x	x	
136	88	x				x			
137	89	x				x			
138	8A	x				x		x	
139	8B	x				x		x	
140	8C	x				x	x		
141	8D	x				x	x		
142	8E	x				x	x	x	
143	8F	x				x	x	x	
144	90	x			x				
145	91	x			x				
146	92	x			x			x	
147	93	x			x			x	
148	94	x			x		x		
149	95	x			x		x		
150	96	x			x		x	x	
151	97	x			x		x	x	
152	98	x			x	x			
153	99	x			x	x			
154	9A	x			x	x		x	
155	9B	x			x	x		x	
156	9C	x			x	x	x		
157	9D	x			x	x	x		
158	9E	x			x	x	x	x	
159	9F	x			x	x	x	x	
160	A0	x		x					
161	A1	x		x					
162	A2	x		x				x	
163	A3	x		x				x	
164	A4	x		x			x		
165	A5	x		x			x		
166	A6	x		x			x	x	
167	A7	x		x			x	x	
168	A8	x		x		x			
169	A9	x		x		x			
170	AA	x		x		x		x	
171	AB	x		x		x		x	
172	AC	x		x		x	x		
173	AD	x		x		x	x		
174	AE	x		x		x	x	x	
175	AF	x		x		x	x	x	
176	B0	x		x	x				
177	B1	x		x	x				
178	B2	x		x	x			x	
179	B3	x		x	x			x	
180	B4	x		x	x		x		
181	B5	x		x	x		x		
182	B6	x		x	x		x	x	
183	B7	x		x	x		x	x	
184	B8	x		x	x	x			
185	B9	x		x	x	x			
186	BA	x		x	x	x		x	
187	BB	x		x	x	x		x	
188	BC	x		x	x	x	x		
189	BD	x		x	x	x	x		
190	BE	x		x	x	x	x	x	
191	BF	x		x	x	x	x	x	

Bit no.		7	6	5	4	3	2	1	0
8-bit value	Hexadecimal	i-bus® Tool	Load shedding	Safety priority 3	Safety priority 2	Safety priority 1	forced operation	Block	Not used
192	C0	x	x						
193	C1	x	x						
194	C2	x	x						x
195	C3	x	x						x
196	C4	x	x				x		
197	C5	x	x				x		
198	C6	x	x				x	x	
199	C7	x	x				x	x	
200	C8	x	x			x			
201	C9	x	x			x			
202	CA	x	x			x			x
203	CB	x	x			x			x
204	CC	x	x			x	x		
205	CD	x	x			x	x		
206	CE	x	x			x	x	x	
207	CF	x	x			x	x	x	
208	D0	x	x		x				
209	D1	x	x		x				
210	D2	x	x		x				x
211	D3	x	x		x				x
212	D4	x	x		x		x		
213	D5	x	x		x		x		
214	D6	x	x		x		x	x	
215	D7	x	x		x		x	x	
216	D8	x	x		x	x			
217	D9	x	x		x	x			
218	DA	x	x		x	x			x
219	DB	x	x		x	x			x
220	DC	x	x		x	x	x		
221	DD	x	x		x	x	x		
222	DE	x	x		x	x	x	x	
223	DF	x	x		x	x	x	x	
224	E0	x	x	x					
225	E1	x	x	x					
226	E2	x	x	x					x
227	E3	x	x	x					x
228	E4	x	x	x			x		
229	E5	x	x	x			x		
230	E6	x	x	x			x	x	
231	E7	x	x	x			x	x	
232	E8	x	x	x		x			
233	E9	x	x	x		x			
234	EA	x	x	x		x			x
235	EB	x	x	x		x			x
236	EC	x	x	x		x	x		
237	ED	x	x	x		x	x		
238	EE	x	x	x		x	x	x	
239	EF	x	x	x		x	x	x	
240	F0	x	x	x	x				
241	F1	x	x	x	x				
242	F2	x	x	x	x				x
243	F3	x	x	x	x				x
244	F4	x	x	x	x		x		
245	F5	x	x	x	x		x		
246	F6	x	x	x	x		x	x	
247	F7	x	x	x	x		x	x	
248	F8	x	x	x	x	x			
249	F9	x	x	x	x	x			
250	FA	x	x	x	x	x			x
251	FB	x	x	x	x	x			x
252	FC	x	x	x	x	x	x		
253	FD	x	x	x	x	x	x		
254	FE	x	x	x	x	x	x	x	
255	FF	x	x	x	x	x	x	x	

Tab. 28: Table of values, Group Object "Status information"

13.3 Table of values, Group Object "Scene 1 ... 64"

The following table contains the telegram code of the 64 Scenes. Each 8-bit Scene is indicated in hexadecimal and binary codes. The 8-bit value is sent when a Scene is recalled/stored.

x = Value 1

Empty = Value 0

Bit no.	7	6	5	4	3	2	1	0		
8-bit value	Hexadecimal	Recall/store	Not defined	Binary number codes	Binary number codes	Binary number codes	Binary number codes	Binary number codes	Scene number	Recall A Store S No reaction -
0	00								1	A
1	01							x	2	A
2	02						x		3	A
3	03						x	x	4	A
4	04					x			5	A
5	05					x		x	6	A
6	06					x	x		7	A
7	07					x	x	x	8	A
8	08				x				9	A
9	09				x			x	10	A
10	0A				x		x		11	A
11	0B				x		x	x	12	A
12	0C				x	x			13	A
13	0D				x	x		x	14	A
14	0E				x	x	x		15	A
15	0F				x	x	x	x	16	A
16	10			x					17	A
17	11			x				x	18	A
18	12			x			x		19	A
19	13			x			x	x	20	A
20	14			x		x			21	A
21	15			x		x		x	22	A
22	16			x		x	x		23	A
23	17			x		x	x	x	24	A
24	18			x	x				25	A
25	19			x	x			x	26	A
26	1A			x	x		x		27	A
27	1B			x	x		x	x	28	A
28	1C			x	x	x			29	A
29	1D			x	x	x		x	30	A
30	1E			x	x	x	x		31	A
31	1F			x	x	x	x	x	32	A
32	20			x					33	A
33	21			x				x	34	A
34	22			x				x	35	A
35	23			x			x	x	36	A
36	24			x		x			37	A
37	25			x		x		x	38	A
38	26			x		x	x		39	A
39	27			x		x	x	x	40	A
40	28			x		x			41	A
41	29			x		x		x	42	A
42	2A			x		x		x	43	A
43	2B			x		x		x	44	A
44	2C			x		x	x		45	A
45	2D			x		x	x	x	46	A
46	2E			x		x	x	x	47	A
47	2F			x		x	x	x	48	A
48	30			x	x				49	A
49	31			x	x			x	50	A
50	32			x	x			x	51	A
51	33			x	x			x	52	A
52	34			x	x			x	53	A
53	35			x	x			x	54	A
54	36			x	x			x	55	A
55	37			x	x			x	56	A
56	38			x	x			x	57	A
57	39			x	x			x	58	A
58	3A			x	x			x	59	A
59	3B			x	x			x	60	A
60	3C			x	x			x	61	A
61	3D			x	x			x	62	A
62	3E			x	x			x	63	A

Bit no.	7	6	5	4	3	2	1	0		
8-bit value	Hexadecimal	Recall/store	Not defined	Binary number codes	Binary number codes	Binary number codes	Binary number codes	Binary number codes	Scene number	Recall A Store S No reaction -
63	3F			x	x	x	x	x	64	A
64	40		x						-	-
65	41		x					x	-	-
66	42		x				x		-	-
67	43		x				x	x	-	-
68	44		x			x			-	-
69	45		x			x		x	-	-
70	46		x			x	x		-	-
71	47		x			x	x	x	-	-
72	48		x			x			-	-
73	49		x			x		x	-	-
74	4A		x			x		x	-	-
75	4B		x			x		x	-	-
76	4C		x			x	x		-	-
77	4D		x			x	x	x	-	-
78	4E		x			x	x	x	-	-
79	4F		x			x	x	x	-	-
80	50		x		x				-	-
81	51		x		x			x	-	-
82	52		x		x			x	-	-
83	53		x		x			x	-	-
84	54		x		x			x	-	-
85	55		x		x			x	-	-
86	56		x		x			x	-	-
87	57		x		x			x	-	-
88	58		x		x			x	-	-
89	59		x		x			x	-	-
90	5A		x		x			x	-	-
91	5B		x		x			x	-	-
92	5C		x		x			x	-	-
93	5D		x		x			x	-	-
94	5E		x		x			x	-	-
95	5F		x		x			x	-	-
96	60		x		x				-	-
97	61		x		x			x	-	-
98	62		x		x			x	-	-
99	63		x		x			x	-	-
100	64		x		x			x	-	-
101	65		x		x			x	-	-
102	66		x		x			x	-	-
103	67		x		x			x	-	-
104	68		x		x			x	-	-
105	69		x		x			x	-	-
106	6A		x		x			x	-	-
107	6B		x		x			x	-	-
108	6C		x		x			x	-	-
109	6D		x		x			x	-	-
110	6E		x		x			x	-	-
111	6F		x		x			x	-	-
112	70		x		x			x	-	-
113	71		x		x			x	-	-
114	72		x		x			x	-	-
115	73		x		x			x	-	-
116	74		x		x			x	-	-
117	75		x		x			x	-	-
118	76		x		x			x	-	-
119	77		x		x			x	-	-
120	78		x		x			x	-	-
121	79		x		x			x	-	-
122	7A		x		x			x	-	-
123	7B		x		x			x	-	-
124	7C		x		x			x	-	-
125	7D		x		x			x	-	-

Bit no.	7	6	5	4	3	2	1	0		
8-bit value	Hexadecimal	Recall/store	Not defined	Binary number codes	Binary number codes	Binary number codes	Binary number codes	Binary number codes	Scene number	Recall A Store S No reaction –
126	7E	x	x	x	x	x	x	x	-	-
127	7F	x	x	x	x	x	x	x	-	-
128	80	x							1	S
129	81	x						x	2	S
130	82	x					x		3	S
131	83	x					x	x	4	S
132	84	x				x			5	S
133	85	x				x		x	6	S
134	86	x				x	x		7	S
135	87	x				x	x	x	8	S
136	88	x			x				9	S
137	89	x			x			x	10	S
138	8A	x			x		x		11	S
139	8B	x			x		x	x	12	S
140	8C	x			x	x			13	S
141	8D	x			x	x		x	14	S
142	8E	x			x	x	x		15	S
143	8F	x			x	x	x	x	16	S
144	90	x		x					17	S
145	91	x		x				x	18	S
146	92	x		x			x		19	S
147	93	x		x			x	x	20	S
148	94	x		x		x			21	S
149	95	x		x	x			x	22	S
150	96	x		x		x	x		23	S
151	97	x		x		x	x	x	24	S
152	98	x		x	x				25	S
153	99	x		x	x			x	26	S
154	9A	x		x	x		x		27	S
155	9B	x		x	x		x	x	28	S
156	9C	x		x	x	x			29	S
157	9D	x		x	x	x		x	30	S
158	9E	x		x	x	x	x		31	S
159	9F	x		x	x	x	x	x	32	S
160	A0	x		x					33	S
161	A1	x		x				x	34	S
162	A2	x		x			x		35	S
163	A3	x		x			x	x	36	S
164	A4	x		x			x		37	S
165	A5	x		x			x	x	38	S
166	A6	x		x			x	x	39	S
167	A7	x		x			x	x	40	S
168	A8	x		x					41	S
169	A9	x		x				x	42	S
170	AA	x		x			x		43	S
171	AB	x		x			x	x	44	S
172	AC	x		x					45	S
173	AD	x		x			x		46	S
174	AE	x		x			x	x	47	S
175	AF	x		x			x	x	48	S
176	B0	x		x	x				49	S
177	B1	x		x	x			x	50	S
178	B2	x		x	x			x	51	S
179	B3	x		x	x			x	52	S
180	B4	x		x	x				53	S
181	B5	x		x	x			x	54	S
182	B6	x		x	x			x	55	S
183	B7	x		x	x			x	56	S
184	B8	x		x	x				57	S
185	B9	x		x	x			x	58	S
186	BA	x		x	x			x	59	S
187	BB	x		x	x			x	60	S
188	BC	x		x	x				61	S
189	BD	x		x	x			x	62	S
190	BE	x		x	x			x	63	S

Tab. 29: Code table 8-bit Scene

Bit no.	7	6	5	4	3	2	1	0		
8-bit value	Hexadecimal	Recall/store	Not defined	Binary number codes	Binary number codes	Binary number codes	Binary number codes	Binary number codes	Scene number	Recall A Store S No reaction –
191	BF	x		x	x				64	S
192	C0	x	x						-	-
193	C1	x	x						-	-
194	C2	x	x					x	-	-
195	C3	x	x					x	-	-
196	C4	x	x				x		-	-
197	C5	x	x				x		-	-
198	C6	x	x				x	x	-	-
199	C7	x	x				x	x	-	-
200	C8	x	x				x		-	-
201	C9	x	x				x		-	-
202	CA	x	x				x	x	-	-
203	CB	x	x				x	x	-	-
204	CC	x	x				x	x	-	-
205	CD	x	x				x	x	-	-
206	CE	x	x				x	x	-	-
207	CF	x	x				x	x	-	-
208	D0	x	x				x		-	-
209	D1	x	x				x		-	-
210	D2	x	x				x		-	-
211	D3	x	x				x	x	-	-
212	D4	x	x				x		-	-
213	D5	x	x				x		-	-
214	D6	x	x				x	x	-	-
215	D7	x	x				x	x	-	-
216	D8	x	x				x	x	-	-
217	D9	x	x				x		-	-
218	DA	x	x				x	x	-	-
219	DB	x	x				x	x	-	-
220	DC	x	x				x	x	-	-
221	DD	x	x				x	x	-	-
222	DE	x	x				x	x	-	-
223	DF	x	x				x	x	-	-
224	E0	x	x				x		-	-
225	E1	x	x				x		-	-
226	E2	x	x				x		-	-
227	E3	x	x				x	x	-	-
228	E4	x	x				x		-	-
229	E5	x	x				x		-	-
230	E6	x	x				x	x	-	-
231	E7	x	x				x	x	-	-
232	E8	x	x				x		-	-
233	E9	x	x				x		-	-
234	EA	x	x				x	x	-	-
235	EB	x	x				x	x	-	-
236	EC	x	x				x	x	-	-
237	ED	x	x				x	x	-	-
238	EE	x	x				x	x	-	-
239	EF	x	x				x	x	-	-
240	F0	x	x				x		-	-
241	F1	x	x				x		-	-
242	F2	x	x				x		-	-
243	F3	x	x				x	x	-	-
244	F4	x	x				x		-	-
245	F5	x	x				x		-	-
246	F6	x	x				x	x	-	-
247	F7	x	x				x	x	-	-
248	F8	x	x				x	x	-	-
249	F9	x	x				x		-	-
250	FA	x	x				x	x	-	-
251	FB	x	x				x	x	-	-
252	FC	x	x				x	x	-	-
253	FD	x	x				x	x	-	-
254	FE	x	x				x	x	-	-
255	FF	x	x				x	x	-	-



ABB STOTZ-KONTAKT GmbH

Eppelheimer Straße 82

69123 Heidelberg, Germany

Tel.: +49 (0)6221 701 607

Fax: +49 (0)6221 701 724

Email: knx.marketing@de.abb.com

**Additional information and regional
points of contact:**

www.abb.de/knx

www.abb.com/knx

© Copyright 2022 ABB. We reserve the right to make technical changes to the products as well as amendments to the content of this document at any time without advance notice. The agreed properties are definitive for any orders placed. ABB AG does not accept any responsibility whatsoever for potential errors or possible lack of information in this document. We reserve all rights in this document and in the subject matter and illustrations contained therein. Reproduction, transfer to third parties or processing of the content – including sections thereof – is not permitted without the prior written consent of ABB AG.

