

KASTA-PGW

Plexy Gateway

Gateway to integrate
with third party
control systems



User's Guide

KASTA is a registered trademark of KASTA Technologies Pty Ltd.

The information in this manual is provided in good faith. Whilst KASTA Technologies Pty Ltd has endeavoured to ensure the relevance and accuracy of the information, it assumes no responsibility for any loss incurred as a result of its use. KASTA does not warrant that the information is fit for any particular purpose, nor does it endorse its use in applications which are critical to the health or life of any human being. KASTA reserves the right to update the information at any time without notice.

Contents

1. Installation Instructions	5
1.1 Product Range	5
1.2 Important Notes	5
1.3 Description	5
1.4 Power Requirements	6
1.5 Electrical Specifications	6
1.6 Mechanical Specifications	7
1.7 Standards Complied	8
1.8 Warranty	9
1.9 Installation Considerations	10
1.10 Definitions	11

Contents

2. Setup	12
2.1 Connecting a device	12
2.2 KASTA App	15
2.3 Adding to network	16
2.4 Bearer Authorisation	18
2.5 Synchronise Plexy Gateway	20
3. Reset Device	22
4. Troubleshooting	23

1.1 Product Range

This document covers the KASTA Plexy Gateway:

Catalogue Number Description	
KASTA-PGW	Gateway to integrate with third party control systems

1.2 Important Notes

KASTA app must be downloaded onto a mobile device and an account setup prior to commissioning the Plexy Gateway.

1.3 Description

The KASTA Plexy Gateway is designed to provide reliable connectivity and control at the edge of third party IoT networks. Using just the Plexy Gateway, Ethernet and KASTA app you can seamlessly integrate to third party control systems. Control of KASTA devices is now possible through third party apps as well as existing KASTA user interfaces and the KASTA app.

1.4 Power Requirements

Supply

6-30VDC, 15W Terminals or Barrel connector

Low Power Mode

15mA “ECO mode”, 250uA sleep w/ RTC wakeup

Operating Temperature

-25°C to 75°C

1.5 Electrical Specifications

Parameter	Description
Power Supply	12V d.c., 15W Terminals or Barrel Connector
Operating Ambient Temperature	-25 to 55°C
Bluetooth® Connectivity	Qualcomm®, Bluetooth® Low Energy 5.0, CSRmesh™
Processor	Cortex-A53 (ARMv8) 64-bit @ 1.2GHz
Flash	16GB
RAM	1GB
OS/Distribution	Linux / Raspbian (default), Ubuntu, etc.
LoWPAN Radio 1 (2.4GHz)	MGM13P on-board, software-defined radio - can also support proprietary protocols
Radio Expansion Socket	XBee socket (SPI and UART)
Ethernet	100BT
Linux Console Port	USB type micro-B (CP2102 serial driver)
Low Power Modes	15mA “Eco mode”, 250uA sleep with RTC wakeup
Security Controller	OPTIGA™ TPM SLM 9670 - Secure Key Store
Battery Backed RTC	Yes, >10 year estimated battery life
No. of supported KASTA systems	1
IP Rating	IP20
Colour	Black
Housing Material	Aluminium, Polycarbonate (PC)
LED Indicators	Blue, Green, Red

1.6 Mechanical Specifications

Parameter	Plexy Gateway
Dimensions (W×H×D)	135 x 85 x 35 mm
Weight	305 g

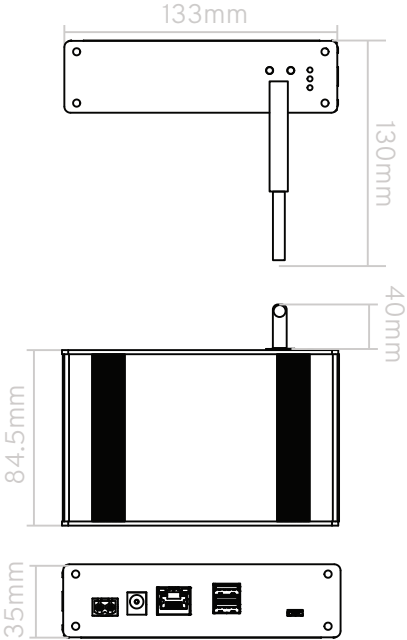

1.7 Standards Complied

DECLARATIONS OF CONFORMITY

Any changes or modifications not expressly approved by KASTA Technologies could void the user’s authority to operate this equipment.

The KASTA Plexy Gateway complies with the following:

Australian/New Zealand EMC & Electrical Safety Frameworks and Standards



Regulation	Standard	Title
RF	AS/NZS 4268,	Radio equipment and systems - Short range devices - Limits and methods of measurement
EMC	AS/NZS CISPR 32	Electromagnetic compatibility of multimedia equipment
Safety		Audio/video, information and communication technology equipment, Part 1: Safety requirements (IEC 62368-1:2014 (ED. 2.0) MOD

1.8 Warranty

The KASTA Plexy Gateway carries a 2-year warranty against manufacturing defects.

Warranty Statement

- 1) The benefits conferred herein are in addition to, and in no way shall be deemed to derogate; either expressly or by implication, any or all other rights and remedies in respect to KASTA Technologies product, which the consumer has under the Commonwealth Trade Practices Act or any other similar State or Territory Laws.
- 2) The warrantor is KASTA Technologies Pty Ltd. With registered offices in all Australian States.
- 3) This KASTA Technologies Product is guaranteed against faulty workmanship and materials for a period of two (2) years from the date of installation.
- 4) KASTA Technologies Pty Ltd reserves the right, at its discretion, to either repair free of parts and labour charges, replace or offer refund in respect to any article found to be faulty due to materials, parts or workmanship.
- 5) This warranty is expressly subject to the KASTA Technologies Product being installed, wired, tested, operated and used in accordance with the manufacturer's instructions.
- 6) All costs of a claim shall be met by KASTA Technologies Pty Ltd, however should the product that is the subject of the claim be found to be in good working order, all such costs shall be met by the claimant.
- 7) When making a claim, the consumer shall forward the KASTA Technologies Product to the point of purchase with adequate particulars of the defect within 28 days of the fault occurring. The product should be returned securely packed, complete with details of the date and place of purchase, description of load, and circumstances of malfunction.

For all warranty enquiries, contact your local KASTA sales representative. The address and contact number of your nearest KASTA Technologies office can be found at <http://www.kasta.com.au/contact-us> or by telephoning Technical Support (02) 8999 1377 (KASTA Technical Support Hotline).

1.9 Installation Considerations

It is important to select a suitable location to install a Plexy Gateway. Some considerations are listed below:

- Units are designed for indoor use only.
- Units may be mounted on a flat level surface.
- Choose a location free of water, humidity, direct sunlight and heavy dust.
- Allow adequate ventilation.
- Do not cover the unit.
- Only use with power supply provided.



No Wet Hands



No Clean Display



No Coverage



No Direct Sunshine



No Dust

=

1.10 Definitions

Term	Definition
Synchronize	Update the status of both KASTA and third party systems
Bearer PIN	PIN required for third party to allow access to Plexy gateway

2.1 Connecting Device

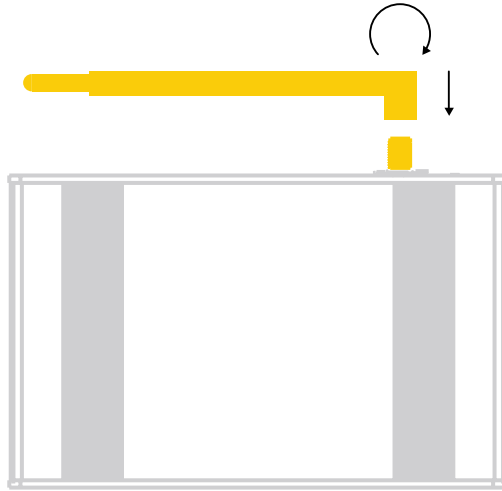

1. Connect antenna to Plexy Gateway

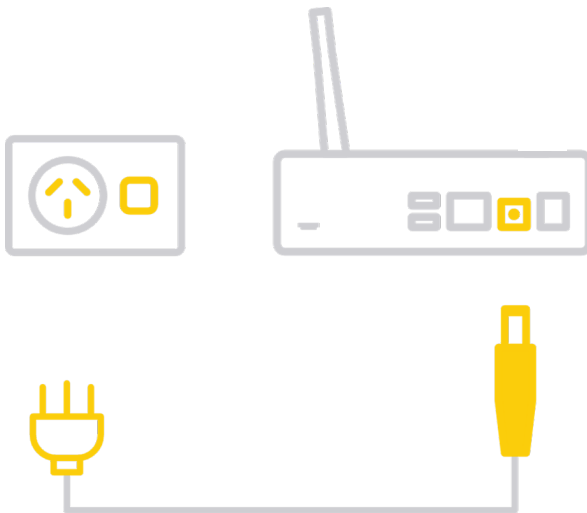

2. Connect the DC cable to socket located on the rear of the Plexy Gateway. Select a suitable location for your gateway. A central location within the home or close to the third party control equipment is ideal.

2.1 Connecting Device cont...

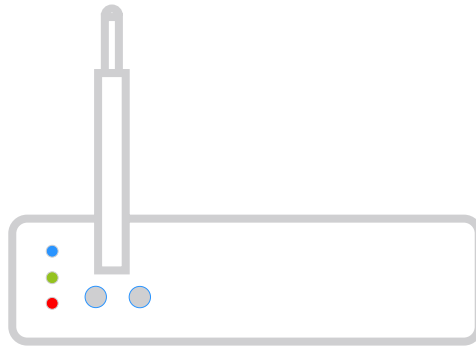

The three LED lights will illuminate brightly.
After approximately 30 seconds, all three LED lights will dim but remain on.

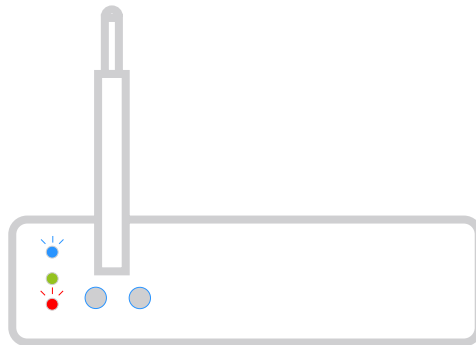

You will now observe:
Blue LED: Flashing
Green LED: Solid
Red LED: Flashing

2.1 Connecting Device cont...

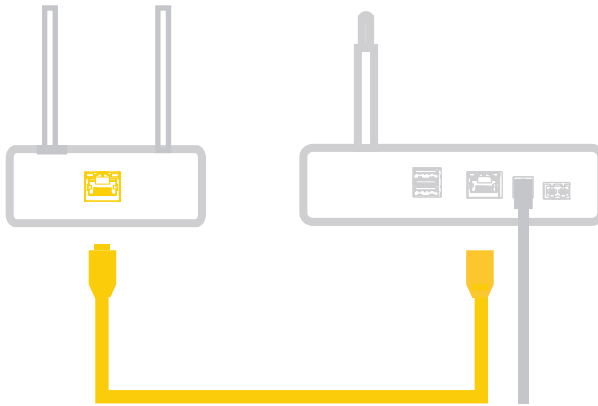

1. Plug the Ethernet cable into the back of your Plexy Gateway.
2. Plug the other end of the Ethernet cable into the network port of your switch or ISP modem.



You will now observe:

Blue LED: Flashing

Green LED: Solid

Red LED: Off

Plexy gateway is ready to connect to your KASTA network.

If the Blue LED is Solid: please reset the gateway.

If the Red LED is Flashing: please check the network is connected.

2.2 Setup - KASTA App

1. If this is the first KASTA device you are installing, download the Kasta app from either the Google Play store or iOS Appstore



2. Create a new KASTA network.

If you are adding the Plexy Gateway to an existing KASTA network you can add it along with any other KASTA devices in any particular order.

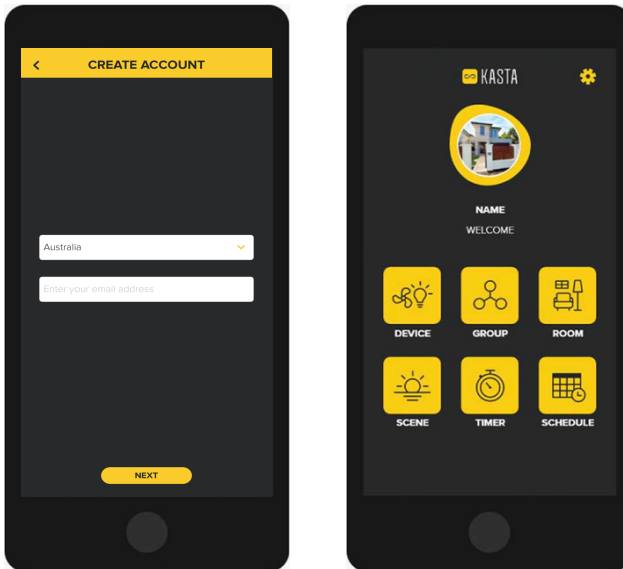

2.3 Setup - Adding to network

1. Once signed into your KASTA account, go to the DEVICE page on the homepage.

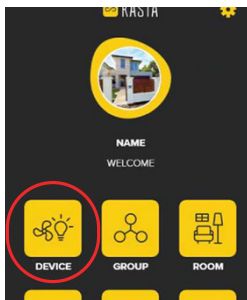

2. Select the "+" symbol in the top left corner of the screen



3. Select the **GATEWAY** then follow the instructions within the KASTA app.
*Note : The gateway adding process may take up to 10 mins.
 - Your smart device and gateway on the same network will use LAN to transfer the devices to the third party system.
 - If your smart device and gateway are not on the same network. It will use BLE to transfer the devices. The speed would be slower than the LAN transfer.

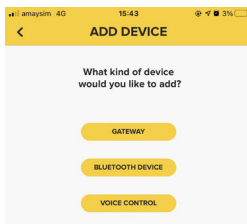

2.3 Setup - Adding to network cont...

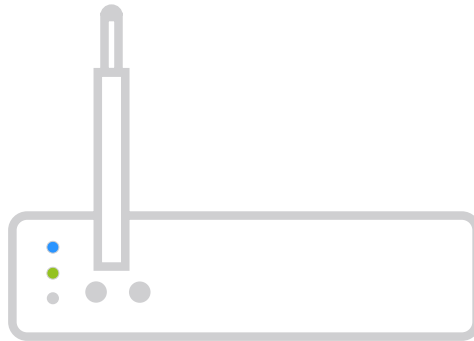

You will now observe:

Blue LED: Solid

Green LED: Solid

Red LED: Off

Plexy gateway has now successfully connected to your KASTA network.

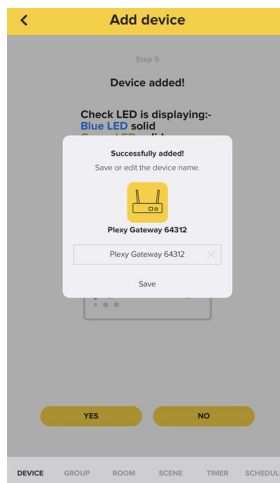

Notification will appear in the app advising that Plexy gateway has now successfully been added.

2.4 Setup - Bearer Authorisation

For Network safety the Plexy Gateway has Network Bearer authorization, when you connect to the third-party Controller, it requires you to enter the network pin for authorization.

You can get the Network pin on: SETTINGS -> Network -> Your Mesh

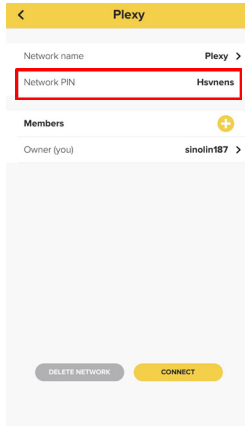

If the the third-party control still not working, Try to resend the PIN.

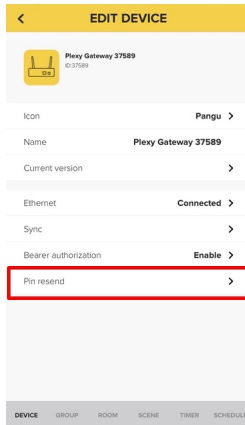

2.4 Setup - Bearer Authorisation cont...

The authorization default setting is Enable. You can change the setting to Disable.

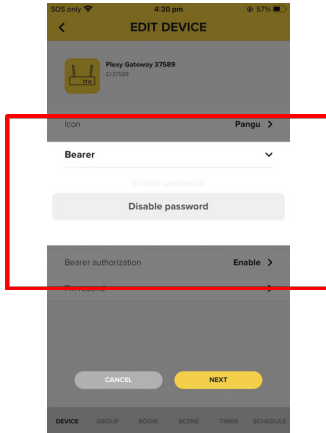

2.5 Setup - Synchronise Plexy Gateway

You must synchronize the KASTA Plexy Gateway if adding, deleting or modifying Kasta devices in order for them to update onto the third party control system.

When you add, delete or modify a KASTA device on the KASTA mesh, the KASTA APP will remind you to synchronize the device list to the Plexy gateway.

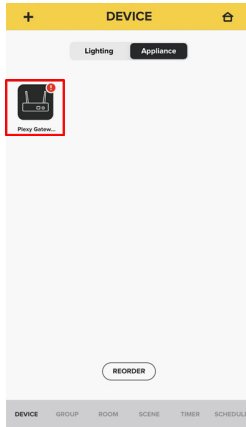

1. Please make sure the Ethernet status is “Connected”.

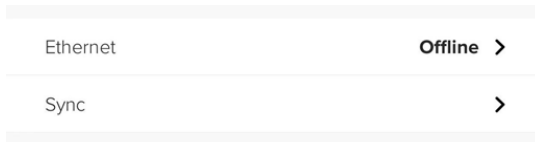

If “Offline” please check the Ethernet cable or network is connected

2.5 Setup - Synchronise Plexy Gateway cont...



If “online”: Please check your mobile phone Bluetooth is turned on.

2. Hold the Plexy Gateway icon to the access the EDIT DEVICE page and press Sync option.

*Note : The synchronisation process may take up to 10mins.

- Your smart device and gateway on the same network will use LAN to sync the devices to the third party system.
- If your smart device and gateway are not on the same network. It will use BLE to sync the devices. The speed would be slower than the LAN synchronisation.

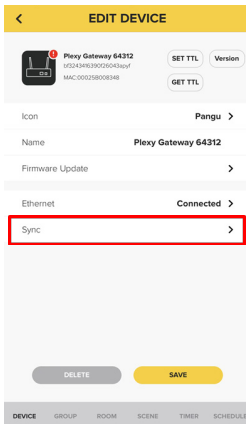

3. Reset Device

If you need to reset the Plexy Gateway you can do so by clicking the RESET button on the gateway 9 times in quick succession

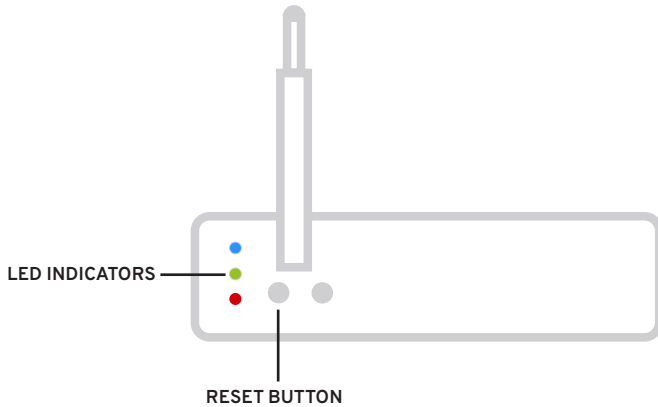

If the rest is successful the LED indicators on the Plexy Gateway will flash 5 times

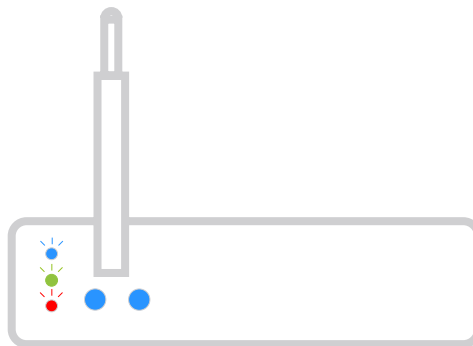

4. Troubleshooting

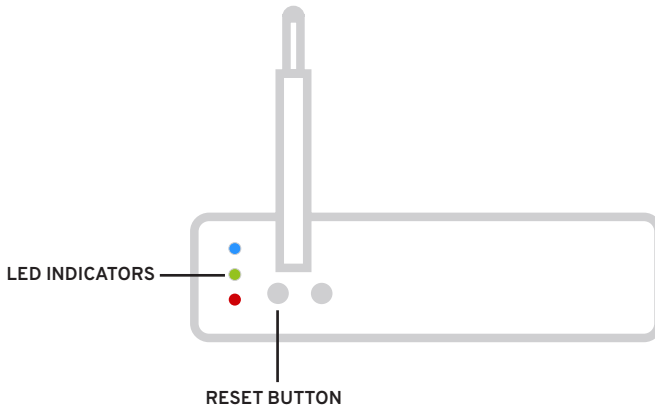

- Solid blue : Bluetooth is connected to my KASTA network.
- ⚡ Flashing blue : Bluetooth is ready to connect to my KASTA network.
- Solid green: Plexy gateway system is ready to connect to my KASTA network.
- ⚡ Flashing red : Ethernet is disconnected to my KASTA network.
- Off red: Ethernet is connected to my KASTA network.



kasta.com.au
(02) 9168 5900