

# Io 4K Plus

Capture, Display, Convert



## Installation and Operation Manual

Version 15.2  
Published June 3, 2019



# Notices

---

## Trademarks

---

AJA® and Because it matters.® are registered trademarks of AJA Video Systems, Inc. for use with most AJA products. AJA™ is a trademark of AJA Video Systems, Inc. for use with recorder, router, software and camera products. Because it matters.™ is a trademark of AJA Video Systems, Inc. for use with camera products.

CION®, Corvid Ultra®, Io®, Ki Pro®, KONA®, KUMO®, ROI® and T-Tap® are registered trademarks of AJA Video Systems, Inc.

AJA Control Room™, KiStor™, Science of the Beautiful™, TruScale™, TruZoom™, V2Analog™ and V2Digital™ are trademarks of AJA Video Systems, Inc.

All other trademarks are the property of their respective owners.

## Copyright

---

Copyright © 2019 AJA Video Systems, Inc. All rights reserved. All information in this manual is subject to change without notice. No part of the document may be reproduced or transmitted in any form, or by any means, electronic or mechanical, including photocopying or recording, without the express written permission of AJA Video Systems, Inc.

## Contacting AJA Support

---

When calling for support, have all information at hand prior to calling. To contact AJA for sales or support, use any of the following methods:

Telephone	+1.530.271.3190
FAX	+1.530.271.3140
Web	<a href="https://www.aja.com">https://www.aja.com</a>
Support Email	<a href="mailto:support@aja.com">support@aja.com</a>
Sales Email	<a href="mailto:sales@aja.com">sales@aja.com</a>

# Contents

---

Notices . . . . .	2
Trademarks . . . . .	2
Copyright . . . . .	2
Contacting AJA Support . . . . .	2
<b>Chapter 1 – Introduction . . . . .</b>	<b>5</b>
Overview . . . . .	5
Features . . . . .	5
High Quality Down Conversion . . . . .	6
Io 4K Plus Audio . . . . .	6
AJA Software & Utilities . . . . .	6
System Requirements . . . . .	7
What's In The Box? . . . . .	7
In This Manual . . . . .	7
<b>Chapter 2 – Installation . . . . .</b>	<b>9</b>
Installation Overview . . . . .	9
System Test Application . . . . .	9
Cable Connections . . . . .	10
Connector Descriptions . . . . .	10
Installing Software . . . . .	11
<b>Chapter 3 – Io 4K Plus Operation . . . . .</b>	<b>13</b>
Front Panel Operation . . . . .	13
Monitor Output and Gain Control . . . . .	13
Audio Level Meters . . . . .	13
Power LED . . . . .	14
AJA Control Panel Overview . . . . .	14
AJA Control Panel User Interface . . . . .	14
Controlling Application . . . . .	16
Presets . . . . .	16
Default Preferences . . . . .	16
Function Screens . . . . .	18
Using Io 4K Plus for UltraHD/4K . . . . .	18
4K/UltraHD Transport Modes . . . . .	18
Io 4K Plus Audio Monitoring . . . . .	20
AJA Control Panel Function Screens . . . . .	22
Control Screen . . . . .	22
Format Screen . . . . .	24
Input Select Screen . . . . .	25
SDI Output Screen . . . . .	27
HDMI Screen . . . . .	29
HDMI HDR Screen . . . . .	31
Video Setup Screen . . . . .	33
Audio Setup Screen . . . . .	35
Audio Mixer Screens . . . . .	36
Audio Mixer Capture Monitor Mode Screen . . . . .	38
Audio Mixer Playback Monitor Mode Screen . . . . .	39
DS Keyer Screen . . . . .	41
LUT Screen . . . . .	43
Timecode Screen . . . . .	45
Presets Screen . . . . .	47
Firmware Screen . . . . .	48
Info Screen . . . . .	49
<b>Appendix A – Specifications . . . . .</b>	<b>50</b>
Audio Connection Pinouts . . . . .	52
<b>Appendix B – Safety and Compliance . . . . .</b>	<b>53</b>

Warranty and Liability Information . . . . . 61  
    Limited Warranty on Hardware. . . . . 61  
    Limitation of Liability . . . . . 62  
    Governing Law and Language; Your Rights. . . . . 62  
Index. . . . . 63

# Chapter 1 – Introduction

---



## Overview

---

AJA io 4K Plus offers a full set of professional video and audio connectivity with support for the latest 4K and UltraHD devices and High Frame Rate workflows. The power of Thunderbolt 3 enables io 4K Plus to handle a wide range of formats from SD to HD, UltraHD and full 4K over both SDI and HDMI and support 4K frame rates up to 60p, plus HDR 10 and HLG support over HDMI for HDR workflows.

io 4K Plus is the ideal companion for lightning-fast video capture, playback and editorial. io 4K Plus connects with a single Thunderbolt cable and provides a second Thunderbolt connector for flexibility, making it perfect for on set, or in the edit suite.

## Features

---

- Two Thunderbolt 3 ports (a pass-through daisy-chaining)
- Four bidirectional SDI BNCs configurable for up to four inputs, or four outputs, or two inputs and two outputs.
- Single Link I/O for 4K/UltraHD, HD and SD across 12G-SDI, 6G-SDI, 3G-SDI, and 1.5G-SDI
- Dual Link I/O for 1.5G-SDI and 3G-SDI (2 x BNC)
- Quad Link I/O for 1.5G-SDI, 3G-SDI (4 x BNC)
- Supports Quadrant or Two Sample Interleave transport
- Automatically downconverts Single Link 4K/UltraHD 12G input to HD on the io 4K Plus SDI 4 output
- HDMI 2.0 Input and Output
- HDR (HDR10 or HLG via HDMI, 12 Bit RGB, BT2020)
- Dedicated realtime 4K/UltraHD to HD down-conversion output (SDI Monitor out BNC)
- Eight-channel Embedded HDMI audio
- Choice of Eight-Channel In, Eight-Channel Out, or Four-Channel In/Out analog audio (DB25 cable, Line Level)
- Front panel LED VU meters and Headphone output w/level control
- Reference In/LTC In (selectable)
- LTC Output
- RS-422 control via 9-pin
- Rugged Chassis, Small Size
- 12V DC, 4-pin XLR Power (AC adapter included)

## Video Formats

---

For a list of supported video formats, see ["Appendix A Specifications" on page 50](#).

## High Quality Down Conversion

---

The Io 4K Plus built-in down-conversion 3G monitor spigot, uses large multi-point digital interpolators, anti-alias filtering and interpolation. Because these functions are in hardware, they are available full time, all the time—with no CPU load.

## Io 4K Plus Audio

---

Io 4K Plus provides up to 16 channels of SDI embedded audio, and up to eight channels of embedded HDMI audio. Eight channels of analog audio I/O is supported via a DB25 industry standard Tascam style audio breakout cable. The eight analog audio channels can be configured as either Ch 1-8 input, Ch 1-8 output, Ch1-4 input with Ch 5-8 output or, Ch 1-4 output with Ch 5-8 input.

## AJA Software & Utilities

---

Io 4K Plus operates with AJA's Desktop software package, developed for powerful integrated video/audio capture, editing, and production with a variety of 3rd-party software. AJA software is distributed as a unified package which includes all the software, firmware, plugins, and utility programs for the Io 4K Plus, as well as AJA's Io, KONA, and T-TAP products.

Two retail packages are available, one for Mac and one for Windows.

## Mac and Windows Packages

---

These packages include:

### Drivers

---

AJA device drivers for tightly integrated hardware/software operation.

### AJA Control Panel

---

The Control Panel provides:

- Source selection and control of your AJA hardware.
- A block diagram to show visually what routing and processing is being performed.

### AJA Control Room

---

Control Room is a cross-platform software application for ingest, playback and output with AJA products.

### AJA System Test

---

System Test provides accurate and detailed evaluations of drive and PCIe performance statistics, allowing you to measure the capabilities of your system for recording and playing back various resolutions and codecs.

### 3rd-Party Plugins

---

Plugins for popular 3rd-party Professional Video Applications from Adobe, Avid, Apple, Telestream, and others.

# System Requirements

---

Your system should meet minimum hardware and software requirements to achieve a satisfactory level of performance. Updates to system requirements are subject to change.

*NOTE: See Software Vendor system requirements for GPU and additional hardware recommendations.*

Recommended system specifications:

- Mac OS 10.12 Sierra or later
- Win 10 or later with all updates
- 2.5 GHz quad core i7 minimum, for HD
- 3.5 GHz eight core minimum, faster processors and more cores recommended, for UltraHD/4K workflows, especially with high frame rate\*
- 16GB RAM minimum, 32GB or more recommended, especially for UltraHD/4K or High Frame Rate applications
- A reasonably fast and powerful graphics card, with plenty of on-board memory. Examples (may be specific to application version and/or host CPU) include:
  - Nvidia K5200
  - Nvidia K4200
  - Nvidia M6000
  - Nvidia M5000
  - Nvidia M4000
  - AMD W7100
  - AMD W8100
- Media storage with adequate bandwidth to sustain the capture and playback of the material you expect to be working with.

*NOTE: For large scale installations with shared storage, or for very high performance requirements, consultation with an experienced a system integrator is recommended. A consultant will be able to assist with many important variables.*

## What's In The Box?

---

As you unpack the shipping box, carefully examine the contents. Ensure you received everything and that nothing was damaged during shipment.

If you find any damage, immediately notify the shipping service and supply them with a complete description of the damage, and contact your dealer or distributor for details on how to have your Io 4K Plus repaired or replaced.

Save packing materials and the shipping box for future use should you need to transport your system or return it for service.

Inside the box you'll find the following components:

- Io 4K Plus
- 12V power adapter and power cord

## In This Manual

---

Chapter 1 - Introduces the product briefly, listing features and system requirements.

Chapter 2 - Provides complete instructions for installing and configuring the product.

Chapter 3 - Discusses operational aspects and how to work with 3rd-party software.

Appendix A - Presents a list of technical specifications for the product.

Appendix B - Provides important Safety and Compliance information.



# Chapter 2 – Installation

---

## Installation Overview

---

1. If not previously installed on your Thunderbolt equipped computer, ensure that appropriate third party application software is installed as detailed in its user documentation.
2. Download and install the latest Io 4K Plus software from:  
<https://www.aja.com/en/support/downloads>
3. Connect your Io 4K Plus to your computer using an appropriate Thunderbolt cable.
4. Connect the video and audio inputs and outputs.
5. Power up the unit (AC supply or battery). The Io 4K Plus will startup automatically.
6. AJA recommends that you now run AJA Control Panel, as this allows you to verify that the installation has completed successfully.

*NOTE: AJA Control Panel will prompt you to update firmware (if the new software package contained a firmware update for your AJA device).*

## System Test Application

---

AJA System Test is a utility for measuring system performance. The application includes:

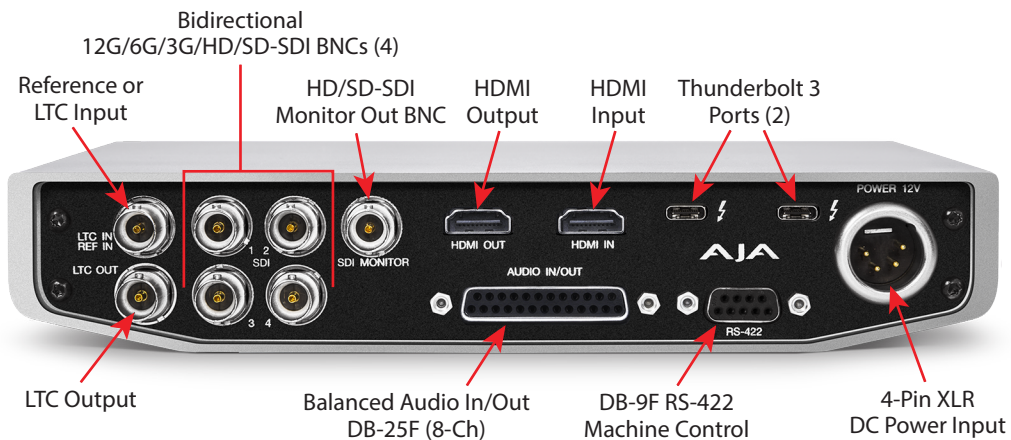
- System Disk Test
- AJA Device Test
- Disk + Device Test
- System Report

The application tests Read and Write, Capture and Playback speeds tests in both Megabytes per second and Frames per second. The disk speed tests differ from standard disk I/O performance applications in that they specifically test the system under conditions typically encountered with video capture, playback, and editing.

Theoretically the best test is to fill your storage disk to 80% and then test capture at the highest data rate you will use.

# Cable Connections

Figure 1. Io 4K Plus Connectors



## Connector Descriptions

### Thunderbolt 3

The Io 4K Plus provides the third-generation Thunderbolt 3 (USB-C) ports to support increased bandwidth between host computer and I/O device. Two ports are provided for daisy-chained network configurations.

### Bi-directional SDI I/O

Four bidirectional BNC connectors can be configured in a variety of ways via the AJA Control Panel, including:

- Two HD/SD inputs (SDI 1 and SDI 2) and two outputs (SDI 3 and SDI 4)
- Two 4K/UltraHD single-link 6/12G inputs (SDI 1 and SDI 2) and two 4K/UltraHD single-link 6/12G outputs (SDI 3 and SDI 4)
- One 4K/UltraHD two-link 3G input (SDI 1 and SDI 2) and one and one two-link 3G output (SDI 3 and SDI4)
- One 4K/UltraHD four-link 1.5/3G input (SDI 1, SDI 2, SDI 3, and SDI4) input, Quadrant or 2SI.
- One 4K/UltraHD four-link 1.5/3G output (SDI 1, SDI 2, SDI 3, and SDI4) output, Quadrant or 2SI.

### Dedicated SDI HD/SD Output

One BNC connector is provided for full-time, real-time output of HD/SD video. 4K video is down-converted to 2K HD and UltraHD is down-converted to HD.

### HDMI Input and Output

Two HDMI connectors provide input and output of HDMI video and multi-channel embedded audio.

- HDMI 2.0 input and output, supporting UltraHD and 4K resolutions at up to 60p (4:2:2), 10-bit and 8-bit
- Supports two or eight channel HDMI audio input and output

HDMI output also supports:

- HDR 10 Support - HDR Infoframe metadata, compatible with HDMI 2.0a/CTA-861.3
- HLG Support - compatible with HDMI 2.0b/CTA-861-G

*NOTE: HDCP is not supported on either input or output. 4K HDMI output does not have HDCP, and input sources having HDCP are not supported.*

The HDMI input is designed to support long cable runs—up to 100 ft. when using 22 or 24AWG HDMI cable, or up to 50 ft. using 28 or 30AWG HDMI cable. The HDMI output supports standard HDMI cables only.

## RS-422 Machine Control

---

A female DB-9 connector provides connection for VTRs, camcorders, disk media servers, and other devices using RS-422 SMPTE (Sony) protocol.

## Reference Video and LTC Input

---

Two BNC connectors provide reference input and LTC output. The Reference Video input can also be used for LTC input. The selection of Reference (sync) or LTC is set using the AJA Control Panel ("[Input Select Screen](#)" on page 25).

Supplying a reference signal to the Reference input allows you to synchronize lo 4K Plus outputs to your house analog reference video signal (or black burst). When connecting a reference video source, the locking signal should be the same as the input format. It is possible in some circumstances to use an alternate format video signal as long as the basic frame rate is compatible.

## Balanced Analog Audio Input and Output

---

A 25-pin connector provides 8-channel balanced analog audio, 24-bit 48kHz sample rate D/A and A/D, for use with an industry standard 8x XLR on DB-25 breakout cable (cable not included). The eight analog audio channels can be configured four different ways:

- Ch 1-8 Output
- Ch 1-4 Input and Ch 5-8 Output (default)
- Ch 1-4 Output and Ch 5-8 Input
- Ch 1-8 Input

## 12V Power Connector

---

A standard 4-pin XLR type connector is provided for either battery or line source power using the supplied AC power adapter.

# Installing Software

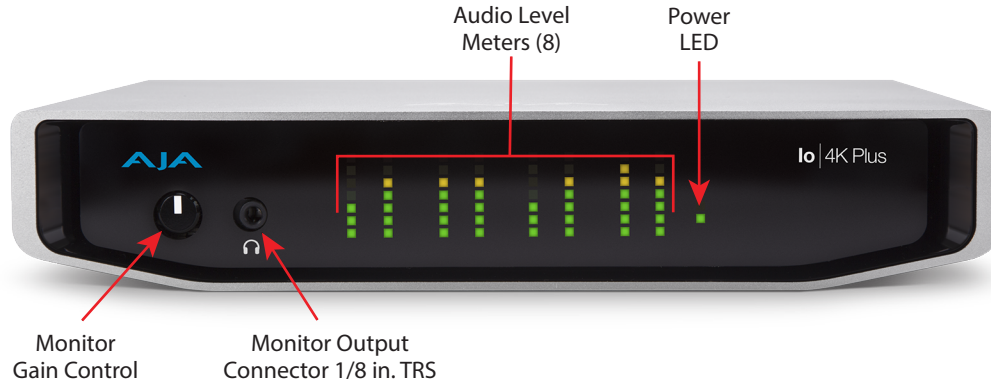
---

*NOTE: If your computer has previously had another video capture or multimedia device installed, ensure you uninstall any related software before installing lo 4K Plus. This will prevent any hardware or software conflicts.*

Before installing the software package, ensure that your capture/editing application is installed as detailed in its user documentation. Before using lo 4K Plus with Avid Media Composer or other NLE application, it is best practice to have installed and run the software at least once on your workstation. Next, install the AJA software package.

If at a later date you add any Io 4K Plus supported applications that require drivers, you must run the AJA install program again to install them.

# Chapter 3 – Io 4K Plus Operation



## Front Panel Operation

The Io 4K Plus front panel has the following controls and indicators:

### Monitor Output and Gain Control

A 1/8 inch TRS connector is available for monitoring two channels of audio, selectable in channel pairs using the Control Panel application. Typically used with a pair of headphones.

The Monitor Gain knob on the left adjusts the monitor output level. Pushing in the knob extends it (for adjustment) or recesses it (to prevent accidental changes).

### Audio Level Meters

The Audio Level Meters in the center of the front panel indicate:

- During Capture - The first 8 channels of the audio source selected (SDI, HDMI, Analog).
- During Playback - The sum of whatever sources are being played out via the AJA hardware; i.e. NLE timeline and mix of host system audio output (if applicable).

The meter's LEDs are colored to indicate the amount below 0dBfs when averaged over a one millisecond time interval:

dBfs	LED Color and Location
-2 db	Red LED 1 (top)
-12 db	Yellow LED 2
-20 db	Yellow LED 1
-30 db	Green LED 4
-40 db	Green LED 3
-50 db	Green LED 2
-60 db	Green LED 1 (bottom)

*NOTE: These audio level meters are for guidance only. Third-party audio metering should be employed when doing critical audio editing and mixing.*

## Power LED

The power LED lights up yellow when power is provided via the power supply. Once a Thunderbolt 3 connection is made, and the host is in an active state, the light turns green.

## AJA Control Panel Overview

The AJA Control Panel is a software application that provides a simple visual showing how the Io 4K Plus hardware is currently configured and allows you to make changes. You can change signal input and output parameters and define the video processing that will be performed.

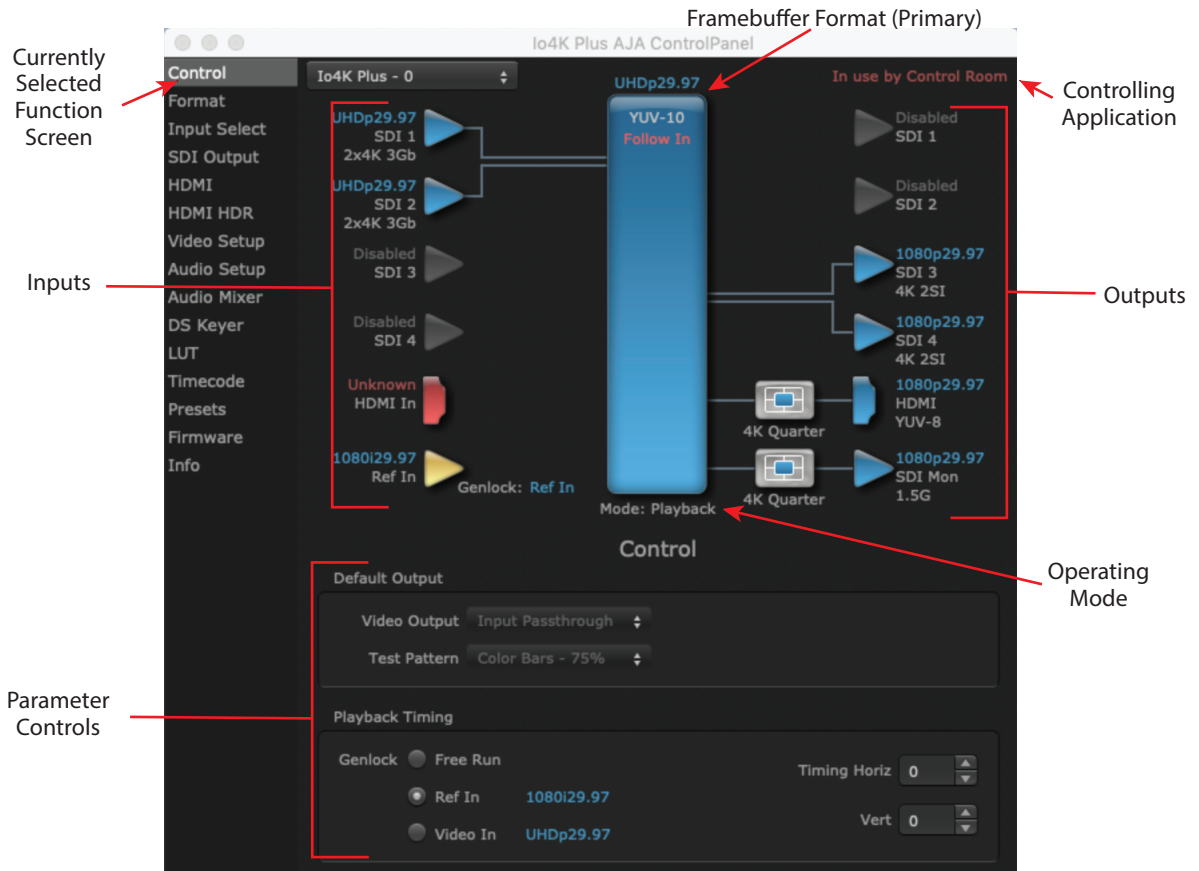
The AJA software installer automatically installs the Control Panel application on your computer. You'll find the AJA Control Panel application in your Applications folder.

## AJA Control Panel User Interface

The AJA Control Panel user interface includes a visual block diagram of the unit's current configuration. The current status, input and output settings, and many other details are depicted in the color-coded block diagram. Below this block diagram are various controls for changing operating parameters, which will vary depending on which function screen has been selected.

The left side of the AJA Control Panel provides a navigation list of available function screens. Clicking on a link (or alternatively, a related element in the block diagram) displays a function screen corresponding to that topic.

Figure 2. Io 4K Plus, Block Diagram set for UltraHD Format



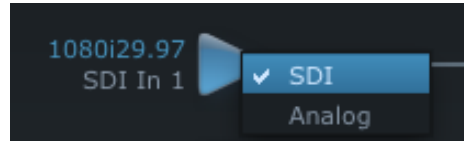
## Block Diagram Area

---

The top block diagram area of the Control Panel screen is a visual representation of the processing, if any, that's currently occurring, including inputs/outputs, reference source, and system status. Lines between inputs, the framebuffer, and outputs, show a video path. Where there are no lines, there is no connection; this can be because an input or output isn't selected in the Input Select menu. The lines will also show whether the outputs are video or video + key.

You can click any of the function screen selection links in the left column to view its current settings or click on an icon to call up its related settings screen. You can also right-click or Control-click to see context-sensitive information and choices (Figure 3).

Figure 3. Context Sensitive Menu



## Color Meanings

---

All items in the AJA Control Panel block diagram are color-coded to show what is happening in real time. This applies to both icons and text. These colors indicate:

**Blue** - Video is same format as the Primary Format (framebuffer)

**Yellow** - Reference video (black burst or other reference source)

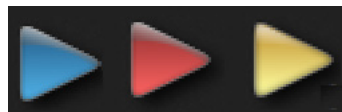
**Red** - The selected operation cannot be performed

## Input/Output Icons

---

The input and output icons are triangles that together with their color show all the input and outputs and their status (selected, not selected, input present or not, format, etc.). A complete video path is shown when inputs and outputs are connected with lines going to/from the framebuffer.

Figure 4. Input/Output Icons



## Framebuffer

---

The framebuffer is the "engine" where your third-party applications interface with the AJA device. The framebuffer has a format (called the "Primary Format") and color space that it follows, as defined in the linked menu screens or via external application software.

## Primary Format

---

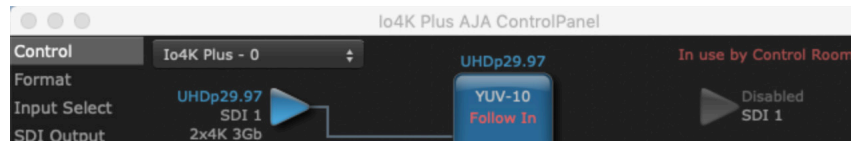
The Primary Format is the media format written to disk and used in your project. This is the format that the framebuffer will use and is shown in the Control Panel using the color blue. It is the format that the third-party application software will either receive from the AJA hardware, or is sending to the hardware. All icons in blue are the same as the Primary Format used by the framebuffer. Also any text descriptions in the block diagram that appear in blue indicate that something is in the primary format.

## Controlling Application

---

It is important to understand that the computer can contain many applications that can use the AJA device (as you switch from window to window) and it may not always be obvious which currently controls it.

Figure 5. Control Panel In Use Message (in red)



In the top right corner, the Control Panel displays the name of the application controlling the unit. In some cases, applications may not always properly “let go” of the I/O interface as another takes over—you’ll be able to tell by looking at the Control Panel.

## Presets

---

Setups can be named and saved as a snapshot (Preset) for recall at any time. You can save various AJA device Control Panel configurations associated with your frequent tasks. You don’t have to spend time resetting interface configurations, just load the previously saved Preset for each task. See ["Saving, Loading and Deleting Presets" on page 47](#) for more information.

If you work on multiple systems and want to carry your saved setups to another location, you can copy your saved Preset files on to movable storage and load them into any computer running the AJA Control Panel application.

### Mac OS Preset Files Storage Location

- From the Finder, hold down the Option key (to display the Library directory) and click on Go/Library/Application Support/AJA/<device name>/Presets/

### Windows Preset Files Storage Location

- c:\Users\<username>\AppData\Local\AJA\Control Panel\<device name> Presets\

## Default Preferences

---

When an AJA device starts up, a preference can determine what settings it will have it when it begins to operate. The AJA Control Panel offers two default preference settings:

- Local Preference - A preference stored from the last AJA device's Control Panel settings to be used on next startup of AJA Control Panel. This occurs on next restoration of the default state (triggered by start up of host CPU, startup of the AJA device, or when a third-party application releases the AJA device).
- Global Preference - A preference saved for use as a global default start state for an AJA device that can be shared by multiple users, applied on first startup, or by pressing the Control Panel **Reset Device...** button.



## Local Preference

---

The Local Preference file (com.aja.devicesettings) exists to immediately and automatically store all parameter changes made by a user on a particular AJA device. When any control is changed in the Control Panel, that change is recorded in the Local Preference file stored in a unique location on that computer that is dedicated to that particular device, serial number, and logged-in user. Then, when AJA Control Panel is restarted for any reason, the AJA device being controlled restores the settings being used when Control Panel was last closed.

The Local Preference file can be accessed at the following locations.

On Mac:

- From the Finder, hold down the Option key (to display the Library directory) and click on Go/Library/Preferences/com.aja.devicesettings.

On Windows:

- C:\Users\<USER\_NAME>\AppData\Local\aja\com.aja.devicesettings

*NOTE: Clicking on the AJA Control Panel "Erase All Prefs" button deletes the existing Local Preference file from this location. This file will be recreated as soon as any Control Panel setting is changed.*

*NOTE: Clicking on the AJA Control Panel "Reset Device..." button will delete the existing Local Preference file. If a Global Preference file is found, these settings are reloaded. If a Global Preference file is not found, "factory defaults" are loaded and the device is set to that state*

## Global Preference

---

An administrator can establish a house standard for an AJA device by copying a preference file to a shared computer location. Once placed at that location, it becomes a Global Preference file where it will establish a standard default startup state for all users of that AJA device using that computer system. These settings preempt the initial AJA factory default settings, and are applied when an AJA device is first powered up, or when the Control Panel **Reset Device** button is pressed.

To establish a Global Preference, the administrator first configures the AJA device (which automatically creates a "com.aja.devicesettings" Local Preference file in the location identified above) and then copy or move that file to the correct computer locations (manually or by pushing it out across the network) on all the computers that use the AJA device.

*NOTE: If the user makes changes to an AJA Device's Control Panel settings, those changes are saved to the Local Preference file, which will take priority over the Global Preference file.*

The shared computer locations for a Global Preference file are:

On Mac:

- From the Finder, click on Go/Computer/<System HD>/Users/Shared/AJA/ and copy or move the "com.aja.devicesettings file" described above to this location.

*NOTE: The "AJA" folder needs to be created manually at this location before moving the preference file into it.*

On Windows there are three possible shared locations depending on your system:

- C:\Users\Public\Aja\
- C:\Users\All Users\Aja\
- C:\ProgramData\Aja\

Copy or move the "com.aja.devicesettings file" described above to one of these locations.

*NOTE: The AJA Control Panel Info screen displays the path to the Global Preference file on that computer.*

*NOTE: Clicking on the AJA Control Panel Erase All Prefs button does NOT delete an existing Global Preference file from this location.*

## Function Screens

---

Listed below are the function screens for Io 4K Plus and what they are used for.

*Table 1. Io 4K Plus Function Screens*

<b>Screen</b>	<b>Functions</b>
Control	Configure basic Io 4K Plus operation options and output timing.
Format	Select the framebuffer primary video format settings.
Input Select	View and edit input selections and audio mapping.
SDI Out	Select output format.
HDMI	Configure the HDMI I/O
HDMI HDR	Configure High Dynamic Range settings for HDMI output
Video Setup	Configure Video such as composite black level, progressive format and ancillary data (Closed Caption) option.
Audio Setup	Configures Audio options such as analog audio input and output channels, audio monitor level, and audio delay.
Audio Mixer	Select and mix audio sources for monitoring.
DS Keyer	Setup and control the insertion of keyed video from the frame buffer or graphics files with alpha channel.
LUT	Load a lookup table (LUT) file to adjust the calibration of color for any source.
Timecode	Monitors SMPTE 12M-2 timecode and configure timecode window burn output.
Presets	Add or delete saved preset configurations (handy for quick and easy recall of different Io 4K Plus settings for varied workflows).
Firmware	Install firmware from your currently installed AJA software package.
Info	Display status information and the firmware version number. This information is generally intended for troubleshooting/support.

## Using Io 4K Plus for UltraHD/4K

---

### 4K/UltraHD Transport Modes

---

The 4K and UltraHD SDI formats can use different transport modes, associated with the number of links used to transport the signal, the data rates involved, and the way the image data is organized.

Io 4K Plus supports both Quadrant and Two Sample Interleave (2SI) transport standards. Many different combinations of modes and data organization exist.

In 4K mode, single link transport is available as either 12G or 6G (which are both 2SI). Whether the video is auto-sensed as 12G vs. 6G is dependent on the data rate of the incoming or outgoing signal. For example, 4K p30 at 8bit 4:2:0 requires 6G only.

Besides single link transport, Io 4K Plus also supports the following multiple link transport modes for UltraHD and 4K:

- Quadrant 4-wire (transported on four links)
- Quadrant 2-wire (transported on two links)
- 2SI (two or four links automatically selected)

The amount of data in the signal affects the number of links and data rates necessary to carry that signal.

## Quadrant Mode

In Quadrant Mode you can use four HD or 2K signals (1.5G) to input / output UltraHD or 4K at 30fps or below, or four 3G signals to enable HFR and / or deep color. Whether using four 1.5G or four 3G wires, each represents individual quadrants of the higher definition UltraHD 3840x2160 or 4K 4096x2160 4K formats. Physical connections of the quadrants will be mapped to the SDI connectors as shown. Monitoring one of these HD signals on a standard SDI monitor will display one quadrant of the picture.

Figure 6. Mapping of Quad SDI Outputs



## 2SI Mode

Two Sample Interleave is an alternative method to organize the data of SDI UltraHD and 4K formats. Instead of dividing the picture raster into quadrants, this method samples pixels to create four lower resolution versions of the entire picture. These are combined later to create the full resolution image.

Figure 7. Mapping of 2SI Outputs



For 2SI UltraHD or 4K SDI video at 30 fps or less, monitoring one of these four signals on a standard SDI monitor displays the entire picture, but at a lower resolution. Above 30 fps, 3G bandwidth is required, so a 3G capable monitor is required.”

*NOTE: In some versions of AJA Control Panel, the 2SI method is referred to as ‘425’ which is a reference to the SMPTE 425 standard which defines this method.*

## 2-Wire and 4-Wire Modes

Using higher data rates, it is possible to carry UltraHD and 4K signals on two SDI links, instead of four. In this situation, half (two quarters) of the image data is carried on one link, with the other half carried on the other link. These types of signals also cannot be viewed on a standard SDI monitor using one connector.

You can choose 2-wire or 4-wire input and output (depending on the type of signal). If the number of links selected is not sufficient, the number of links is automatically increased to accommodate the signal. UltraHD or 4K SDI signals 30 fps and below can be input and output simultaneously, using two connectors in each direction. However, all four connectors are required above 30 fps. You will be able to either input or output a high frame rate SDI signal, not both at the same time. In this situation, you can use the down-converted SDI monitor output to monitor the input signal, or use the HDMI output. Note that to monitor incoming UltraHD/4K SDI as HDMI UltraHD/4K, the SDI input transport must be 2SI. Quad SDI will be down-converted to HD on the HDMI output.

Specifying the number of wires for output forces Quadrant mode. You cannot specify the number of links when 2SI output is selected (the lowest number of links will be set automatically).

## Single-Wire Modes

---

KONA 5 supports 12G SDI and 6G transport over a single link. All formats described above can be carried on this link, but the associated source and destination equipment must support single-link 12G (high frame rate) or 6G (lower frame rate) video.

In Single-Wire 12G output mode, KONA 5 automatically outputs a down-converted 2K or HD signal on SDI output 4, along with the 4K/UltraHD signal sent to SDI output 3.

## Io 4K Plus Audio Monitoring

---

Io 4K Plus hardware can be used as your single audio monitoring solution whether you are auditioning music in a web browser, playing a movie file on the desktop, creating music, or playing a YouTube clip. As long as the output of your work or application is normally output via the host system audio, your AJA hardware can route this audio for monitoring. This cuts down on unnecessary cabling, and means you can take advantage of a consistent audio monitoring environment whatever you are currently doing with your host system.

*NOTE: On first use, you will need to tell your operating system to use AJA hardware as the default Input and Output hardware.*

Io 4K Plus lets you listen to Host System audio concurrently with your NLE audio. This is useful if you need to audition music tracks against playback of your NLE timeline, or if you need to Skype with a remote producer during an edit session, or for a myriad of other reasons.

You can also listen to Io 4K Plus Input concurrently with your NLE (with the exception of Avid Media Composer). This is useful if you need to listen out for the readiness of talent, or the presence of some other feed, whilst you continue to work.

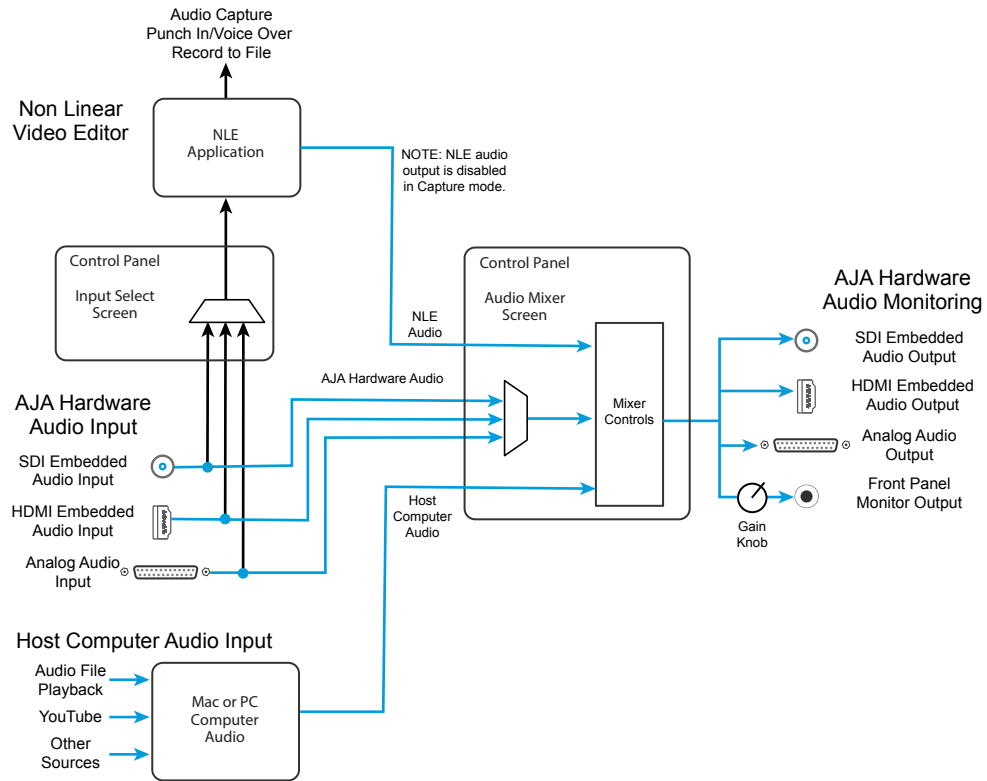
Io 4K Plus audio monitoring is routed and mixed using the Control Panel application's Audio Mixer screen. You can select sources to be monitored, and can adjust their levels. If you are using the 1/4 inch monitor output connector, an additional overall mix gain control is conveniently available on the Io 4K Plus's front panel.

The mixed audio monitor signal is also routed to:

- SDI Audio out
- HDMI Audio Out
- Analog Audio Out (via DB25 cable)

**IMPORTANT:** Even though you can hear changes in the signals and levels adjusted with the Audio Mixer screen, these changes are NOT recorded to disk during NLE Capture or Audio Punch In / Voice Over to Timeline. The Audio Mixer screen is dedicated for monitoring only, not program mixing.

Figure 8. Io 4K Plus Audio Monitoring Routing Diagram



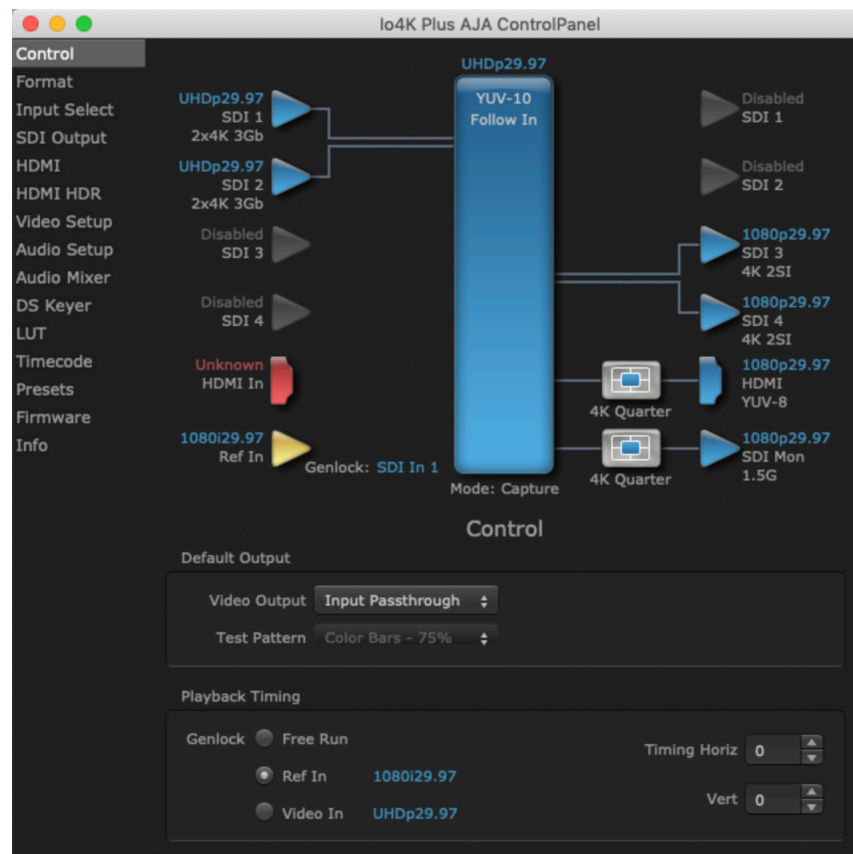
To control which AJA hardware audio is used during recording, you use the Control Panel application's Input Select Screen, Audio Input Select drop down to select from

- SDI embedded
- HDMI embedded
- Analog (via DB25 cable)

Any level adjustments to Capture or Audio Punch In / Voice Over to Timeline recording operations will either need to be made upstream of the AJA input, or else via adjustments within the main NLE application (e.g. via a pass through mix tool).

# AJA Control Panel Function Screens

## Control Screen



The Control Screen is where you set the Default Output, what the device outputs when no application has control of the board. This screen also has controls for setting the genlock source, and for setting the Horiz and Vert timing offsets. The top of the Control Screen shows the current state of the device and also shows the name of the Application which has control of the board, if there is one.

## Default Output

Many video applications can grab control of the io 4K Plus, so its outputs can change dynamically. The Default Output settings are used to select what will be output when no third-party video application is controlling io 4K Plus.

### Video Output

- **Input Passthrough** - This selection directs io 4K Plus to route video from its selected input through the card for processing and output.
- **Test Pattern** - This selection directs io 4K Plus to output a preset pattern when no other application is in control. The pattern is selected from the Test Pattern dropdown list below, or a graphic file can be chosen.
- **Hold Last App** - This selection directs io 4K Plus to hold and output the last frame of video from the last application to control io 4K Plus. This can be helpful when operating in an environment where you're switching back and forth between multiple application windows.

## Test Pattern

---

With Test Pattern selected above, you can choose the pattern type. Select from:

- Black, Color bars (75% or 100%), Ramp, Multiburst, Line Sweep, Multi Pattern, or Flat Field, Check Field, White, Border, Linear Ramp, Slant Ramp, Zone Plate, Color Quadrant, or Color Quad Border.

## Graphic File Display

---

In addition to the test patterns above, a “Load File...” selection at the bottom of the Test Pattern dropdown menu allows you to load a standard RGB/RGBA graphics file (.tif,.psd, etc.) into the frame buffer for display (including alpha channel). Some graphics formats and bit depths may not be supported. Files that have been loaded are listed for quick reuse. Loaded graphic files are retained for redisplay if another test pattern is selected, and even if Io 4K Plus is power cycled.

*NOTE: A loaded graphics file will not be scaled to fit. If it's smaller than the current frame buffer format, Io 4K Plus will center it in the frame. If larger than the current frame buffer format it will be cropped.*

- Clear Files - This selection on the pulldown clears all the Graphic Display files.

## Playback Timing

---

Use these controls to set the Genlock source and Timing adjustment.

### Genlock

---

Selects how Io 4K Plus will synchronize program video:

- Freerun: Generates sync without an external reference source
- Ref In: Use the Ref Video source for sync (usually an analog black burst video signal)
- Video In: Use whichever video input source has been selected in the Inputs screen for sync

For video stability and proper system operation, you can genlock all equipment to house sync. However genlock is not required for Io 4K Plus due to its excellent freerun accuracy. On the Io 4K Plus house sync is connected to “LTC/Ref In”.

Alternatively, Io 4K Plus can receive externally supplied Linear Time Code on that same input connector. The LTC/Ref setting on the Input Select screen (see "[LTC/Ref](#)" on page 26) selects how that input signal will be used.

### Timing (Horiz and Vert)

---

These two pull-downs allow output timing adjustment with reference to the Ref Video source selected.

- Horizontal: The Horizontal reference can be adjusted by selecting a number of pixels (clocks) to offset
- Vertical: The vertical reference can be adjusted by specifying a number of lines to offset.

## Format Screen



The Format Screen shows the video format currently in use by the Io 4K Plus framebuffer (called the Primary Format) and allows you to change it. All throughout the Control Panel, choices are always presented based on what Io 4K Plus can do with the signals available and the inputs/outputs selected.

**IMPORTANT:** Do not confuse this Format function screen conversion, which uses AJA hardware and operates on either Mac or PC, with the separate Conversion function screen, which uses QuickTime for conversion and is only available on Mac OS.

## Primary (Frame Buffer) Format

### Format

This pull-down menu shows the currently selected format. When a change is made via the Video Format pull-down or by clicking an icon and selecting a new format via a contextual menu, the block diagram will change to reflect the new format.

**NOTE:** The Format control is not active when an application has control of the Io 4K Plus.

### Follow Input

Enabling the Follow Input checkbox allows the Control Panel Buffer to auto-switch to whatever is the detected input format. This feature works if the controlling application supports input-based capture—Avid Media Composer or AJA Control Room for example. Follow Input can also be active when there is no 3rd party controlling application and the Default Output setting is Input Passthrough (see ["Video Output" on page 22](#)).



## Pixel Format

Use this pulldown menu to choose from:

- YUV-10, YUV-8, RGB-10, ARGB-8, or RGB-12

## RGB Range

The RGB Range pulldown menu allows you to select either:

- Full range (0-1023)
- SMPTE range (typically 64-940) for RGB color output.

*NOTE: RGB Range is only used when the SDI input or output is configured for RGB.*

## Input Select Screen



On the Input Select screen you can view or set the currently selected video and audio input sources and map audio sources to the channels supported by your editing application. Two information panes in the screen are provided: Video Input and Audio Input.

## Video Input

---

### Source

---

The pulldown menu allows you to select the currently selected video input source. Select from:

- Auto - Automatically selects the source depending on input format.
- SDI 1
- SDI 2
- SDI 2xHD
- SDI 2x4K
- SDI 4x4K
- HDMI

### SDI Color Sp

---

Sets the color space. Select from Auto, YUV, or RGB.

### SDI RGB Rng

---

Sets the RGB range. Select from Auto, SMPTE, or Full.

### LTC/Ref

---

Use the LTC/Ref menu pulldown to identify the type of signal being received by the LTC/Ref BNC:

- Reference - BNC is used as a video reference input.
- LTC- BNC is used for linear time code (LTC) input.

## Audio Input

---

### Select

---

This pulldown menu allows you to pick where the audio comes from. Select from:

- Auto
- Analog
- HDMI
- SDI 1 Ch1-16
- SDI 2 Ch1-16

### Ch Map

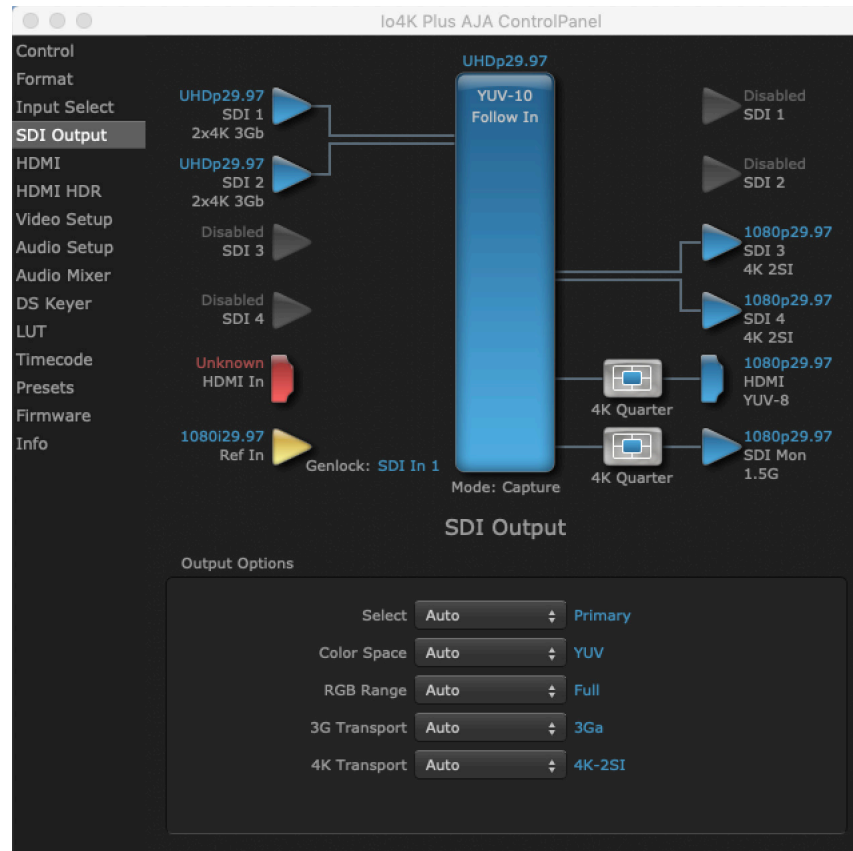
---

If only two channels were selected in the third-party application you are using, you can select which two channels will be mapped to that application. Different Audio Input selections have different channel mapping capabilities. Select from:

- 1-2 to 1-2
- 3-4 to 1-2
- 5-6 to 1-2
- 7-8 to 1-2
- 9-10 to 1-2
- 11-12 to 1-2
- 13-14 to 1-2
- 15-16 to 1-2

**NOTE:** *This setting does not affect the embedded audio being sent to the Io 4K Plus's BNC or HDMI output connectors.*

## SDI Output Screen



The SDI Out screen shows the current settings for the SDI outputs. The outputs can be configured independently. If an input/output has no video, it will be indicated on the block diagram (“No Video”).

## Output Options

### Select

- Auto - Automatically selects the output format, based on the input or selected format.
- Primary - Selects the framebuffer format for output.
- Video+Key - When selected, this indicates that the SDI 3 video is set to the same format as the framebuffer. SDI 4 is set to a video key signal associated with SDI 3 (the shape to be cut out from the video - this will appear as a black and white image/matte). Using the second KONA output as an Alpha Channel key, with the video output, may be useful for feeding production switchers, DVEs or other professional video equipment.

### Color Space

Sets the color space. Select from Auto, YUV, or RGB.

### RGB Range

Sets the RGB range. Select from Auto, SMPTE, or Full.

## 3G Transport

---

Sets the output transport. Select from:

- Auto - Auto selection based on input or selected format
- 3Gb - Single link HD output using one BNC. The Level B-DS format is the dual-stream carriage of two independent HD-SDI/SMPTE 292M signals (720p up to 60 fps or 1080i/1080p up to 30 fps) in a single serial digital interface at the nominal 3 Gbit/s.
- 3Ga - Single link HD output using one BNC. The Level A format is the direct mapping of uncompressed 1080p (up to 60 fps) video into a serial digital interface at the nominal 3 Gbit/s.
- 2xHD-DL: Dual link HD output using two BNCs. The Level B-DL format is the mapping of dual-link HD-SDI/SMPTE 372M (i.e.: 1080p up to 60 fps) in a single serial digital interface at the nominal 3 Gbit/s.

## 4K Transport

---

Sets the 4K output transport. Select from:

- Auto - Automatically selects the transport, based on the input or selected format.
- 4K-2si - Sets 2si output, using multiple links.
- 1x 4K-12G (KONA 5 only) - Single link 12G output. This signal will also automatically be downconverted and routed to the SDI 4 output.
- 2x 4K-Quad - Dual Link 4K/UltraHD output, SQD.
- 4x 4K-Quad - Quad Link, SQD.
- 1x 4K-Quarter - Downconverts the 4K/UltraHD signal to HD.

*NOTE: The 4K Transport setting also affects the lo 4K Plus HDMI output signal, even if the SDI inputs are not being used. A 12G/6G 1-Wire or SMPTE 2Si setting is required for UltraHD/4K HDMI output. Other 4K Transport settings will down-convert HDMI output to HD or 2K.*

## HDMI Screen



The HDMI input and output are configured with this screen.

**NOTE:** The 4K Transport setting on the SDI Out screen also affects the io 4K Plus HDMI output signal, even if the SDI inputs are not being used. A 12G/6G 1-Wire or SMPTE 2Si setting is required for UltraHD/4K HDMI output. Other 4K Transport settings will down-convert HDMI output to HD or 2K.

## HDMI Output

### Source

For UltraHD/4K formats, this pulldown lets you choose:

- Primary – Full 4K or UltraHD format
- 4K Quarter - Down-converts 4K to 2K, and UltraHD to HD.

### Audio Ch

This pulldown allows you to select the number of embedded audio channels for the HDMI output. Two or eight channels can be chosen. Select from:

- 2 Ch 1-2 through 15-16
- 8 Ch 1-8
- 8 Ch 9-16

## Ch 3/4 Swap

---

This checkbox controls HDMI input audio channel placement. Some multi-channel audio decoder systems route the low frequency effects audio to channel 4, and some to channel 3. If you want to monitor or pass audio though to another device, this control can be used to align these two channels correctly.

- Checked - (default) HDMI audio channel 3 is moved to channel 4's location, and input channel 4 is moved to channel 3's location.
- Unchecked - HDMI audio retains the original 3 and 4 channel locations.

## Protocol

---

This pulldown allows you to choose:

- Auto Detect - Selects HDMI or DVI depending on signal.
- HDMI - Selects HDMI.
- DVI - Selects DVI. Use when outputting to a DVI monitor using an HDMI to DVI adapter.

## Color Space

---

Sets the color space bit depth. Select from:

- RGBA 8bit
- RGB 10bit

## RGB Range

---

This pulldown lets you configure video output range. Choose from:

- SMPTE
- Full

## HDMI Input

---

The detected HDMI input video format is displayed and you're given a chance to configure the RGB range of the HDMI input.

### Audio Ch 3/4 Swap

---

This checkbox controls HDMI output audio channel placement. Some multi-channel audio decoder systems route the low frequency effects audio to channel 4, and some to channel 3. If you want to monitor multi-channel audio directly or pass audio though to another device, this control can be used to place these two channels correctly.

- Checked - (default) HDMI audio channel 3 is moved to channel 4's location, and input channel 4 is moved to channel 3's location.
- Unchecked - HDMI audio retains the original 3 and 4 channel locations.

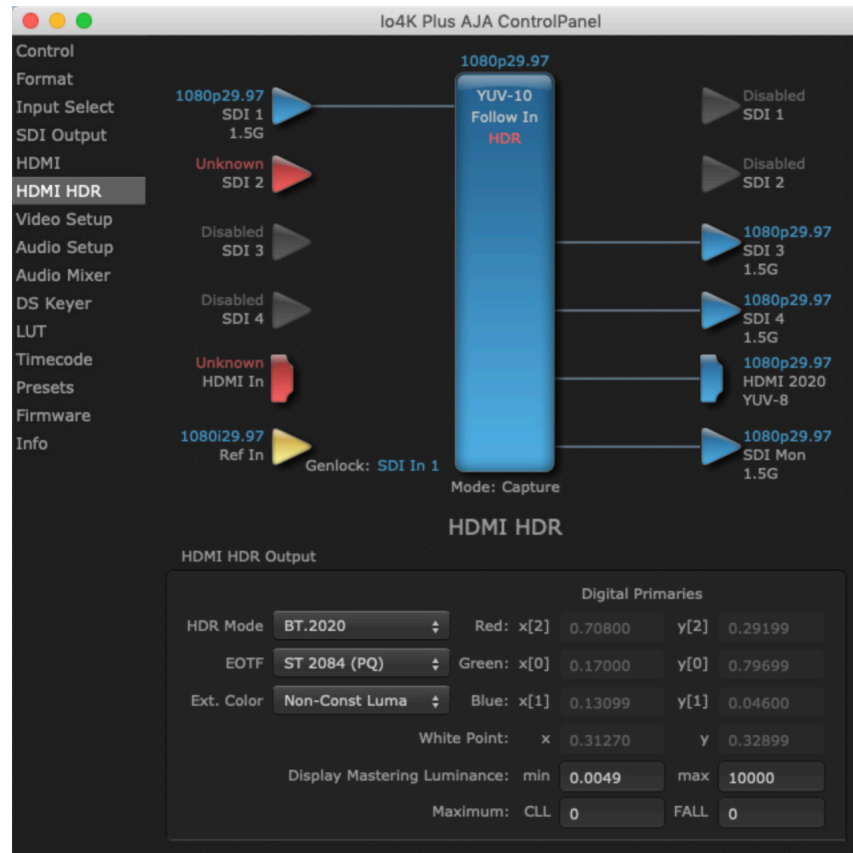
### RGB Range

---

Choose from:

- SMPTE
- Full

# HDMI HDR Screen



The HDMI-HDR screen provides a mechanism to inform an HDMI sink device (such as a TV or monitor) that the video content is HDR. This includes generation of the Dynamic Range and Mastering Infoframe and the static metadata descriptors as defined in CTA-861.3 and HDMI v2.0a. Included are preset primaries values for BT.2020 and DCI P3 color gamuts.

## HDR Mode

- Off - HDR Mode disabled (default).
- DCI-P3 D65 - Only Display Mastering Luminance available for Digital Primaries.
- BT.2020 - Typically used with HDR.
- Custom - Allows custom values for the Digital Primaries.

## EOTF

The Electrical Optical Transfer Function metadata bit tells the HDMI display which EOTF to use. Most TV's will require this to be set to ST 2084 for their HDR modes.

- Trad Gamma SD
- Trad Gamma HD
- ST 2084 (PQ, HDR-10)
- HLG (Hybrid Log Gamma) - No metadata for Digital Primaries.

## Ext. Color

Most TV's require this be set to Non-Const Luma to go into their HDR modes.

## Digital Primaries

---

Selecting Custom HDR Mode allows the editing of digital primaries information that is passed as metadata accompanying the video signal. However, when HLG selected as the EOTF digital primaries information cannot be edited, because HLG does not use metadata.

### Display Mastering Luminance

---

Represents the minimum and maximum Display Mastering Luminance.

- **Minimum:** Defines the floor of the SMPTE ST 2086 color volume (in the case of HDR) and is determined by the mastering environment.
  - Range: 0.0000 cd/m<sup>2</sup> to 1.0000 cd/m<sup>2</sup>.
  - Step size: 0.0002 cd/m<sup>2</sup>.
- **Maximum:** Defines the ceiling of the SMPTE ST 2086 color volume (in the case of HDR) and is determined by the mastering environment.
  - Range: 1 cd/m<sup>2</sup> to 65535 cd/m<sup>2</sup>.
  - Step size: 1 cd/m<sup>2</sup>.

### Maximum Content Light Level (CLL)

---

Represents the highest-value pixel component in an entire scene. It is determined by analyzing each frame of video, and can be determined in the post environment.

- Range: 1 cd/m<sup>2</sup> to 65535 cd/m<sup>2</sup>.
- Step size: 1 cd/m<sup>2</sup>.

### Maximum Frame Average Light Level (FALL)

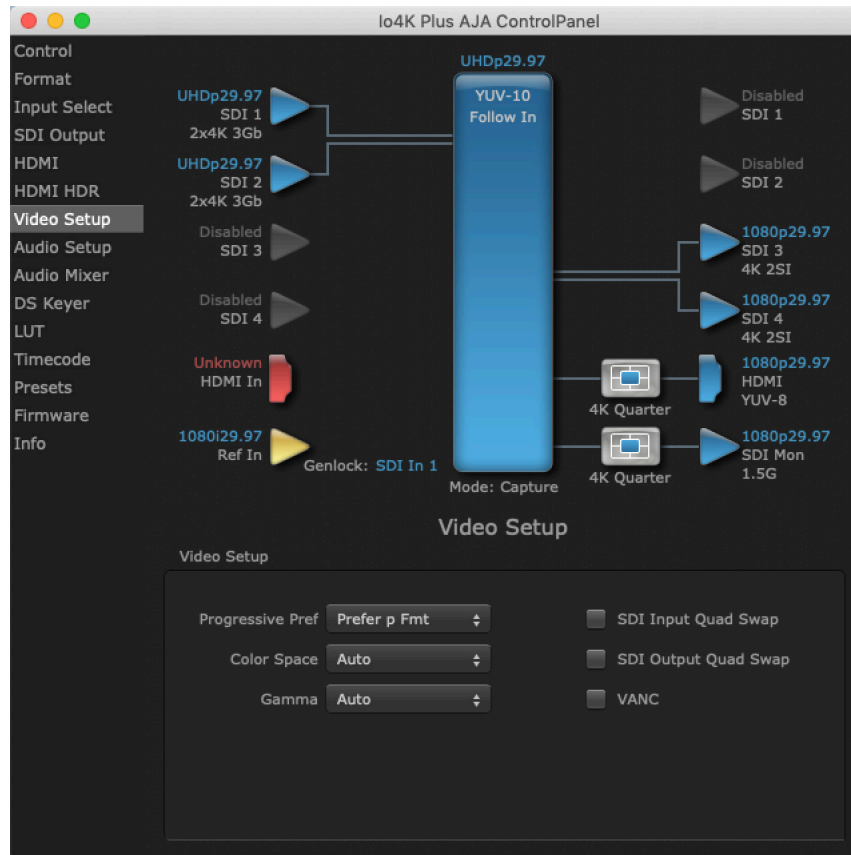
---

Represents the maximum of frame-based average light levels taken over an entire scene, and can be determined in the post environment.

- Range: 1 cd/m<sup>2</sup> to 65535 cd/m<sup>2</sup>.
- Step size: 1 cd/m<sup>2</sup>.



# Video Setup Screen



The Video Setup screen shows various other settings which will affect how video inputs and outputs behave, and how io 4K Plus interacts with some software applications.

## Video Setup

### Progressive Pref

This feature is used to default the hardware to use either p or PsF output over SDI when it has not been specified by the application. Choose between:

- Prefer p Format - progressive frames non-interlaced output
- Prefer psf Format - progressive segmented frames

**NOTE:** *If you change this option while your NLE is open and running, you may need to then make a change in one of your NLE settings in order for this to be reflected dynamically in the project. For example in Media Composer, simply toggling the Video Quality menu in the Timeline should cause a project format refresh to occur, thus recognizing the change you just made in Control Panel.*

### Color Space

Sets the video color space. Select from:

- Auto
- Rec 601
- Rec 709

## Gamma

---

Sets the video gamma. Intended for use with legacy Apple displays. Select from:

- Auto
- Gamma 1.8

## SDI Input Quad Swap

---

When checked (default setting), changes the input Quad to SDI quadrant mapping from 1 to 1 to:

Quad1	SDI3
Quad2	SDI4
Quad3	SDI1
Quad4	SDI2

See "[Automatic Io 4K Plus 4-Link to 2-Link Switching](#)" on page 34 for more detailed information.

## SDI Output Quad Swap

---

Same as SDI Input Quad Swap above, but is applied to the SDI outputs.

## VANC Checkbox

---

When checked, the VANC checkbox tells the Io 4K Plus to capture and process any ancillary data in the SDI stream. This can include different types of metadata. Applications such as Premiere Pro and Final Cut Pro will not capture or output this data through the Io 4K Plus if this box is not checked.

*NOTE: Io 4K Plus does not require enabling the VANC checkbox for Closed Captioning.*

## Automatic Io 4K Plus 4-Link to 2-Link Switching

---

You can use Quad Swap settings to automatically switch Io 4K Plus 4K operation from 4-Link to 2-Link transport, without the need to repatch Io 4K Plus BNCs for each transport change. This can be useful if, for example, you want to connect Io 4K Plus's outputs to an SDI monitor that sometimes views 4-Link 4K/UltraHD inputs, and sometimes views 2-Link or Single-Link HD inputs. All that is required is to re-orient Io 4K Plus's output BNC connectors once, and turn on SDI Output Quad Swap.

### Auto Link Switching Configuration Example

---

For 4K/UHD monitoring (Frame Buffer set to 4K raster – transport set to 4x 4K):

1. Connect the Io 4K Plus output SDI BNCs in the following manner:

- Io 4K Plus SDI 1 Output -> to -> Monitor SDI 3 Input
- Io 4K Plus SDI 2 Output -> to -> Monitor SDI 4 Input
- Io 4K Plus SDI 3 Output -> to -> Monitor SDI 1 Input
- Io 4K Plus SDI 4 Output -> to -> Monitor SDI 2 Input

At this time when you view 4K/UHD over the 4x 3G-SDI links on the monitor, the quadrants will not be displayed correctly.

2. Enable the Control Panel "SDI Output Quad swap" feature. Now the 4K/UHD monitor will display the quadrants correctly.

To make the monitor display a single or dual link 2K/HD RGB or YUV output, simply set the Io 4K Plus framebuffer to 2K Raster and the transport to 2xHD-DL. With the settings above, Io 4K Plus will automatically change its outputs to SDI 3 and SDI 4, and the monitor will display the 2K/HD image correctly, and vice versa.

The reverse function is also possible, using “SDI Input Quad swap”, allowing swapping back and forth between quad 4K input and dual link 2K input without having to re-patch.

## Audio Setup Screen



The Audio Setup screen shows the current settings for the analog audio output, allowing you to re-configure it when desired.

### Audio Monitor

This control selects which pair of channels from the NLE will be monitored. For most editing scenarios this should remain as Ch 1-2, since most NLEs default to dual track / stereo monitoring as a sum of the entire timeline.

*NOTE: This setting only applies to dual channel monitoring environments (for example, the headphone jack on the front of the io 4K Plus).*

Select from:

- Ch 1-2 through Ch 15-16

### Analog Audio Monitor Level

This selection determines the analog audio output level (“FSD” is full-scale-deflection reading as measured on a VU meter). In addition to the front panel monitor (headphone) output, this setting also effects the analog output via the DB25 cable. Select from

- +24dBu, +18dBu, +15dBu, or +12dBu

## Analog IO Select

---

This setting configures the analog audio input and output channels on the DB-25 connector. Choose from:

- 8-Out
- 4-In 4-Out (Ch 1-4 in, Ch 5-8 out)
- 4-Out 4-In (Ch 1-4 out, Ch 5-8 in)
- 8-In

## Delay In and Out

---

Here you can set up to 6 frames (in tenths of a frame) of delay for the AJA device's audio input and output. The AJA Control Panel delays all audio outputs—SDI, HDMI, and Analog. This feature is useful in compensating for the processing delay of a video monitor when audio is being monitored directly from the Io 4K Plus (for example, when an audio mixer is connected to the DB25 analog audio inputs).

*IMPORTANT: If you use this Control Panel delay, do not use other delay settings in your applications, as they can conflict with one another.*

## Audio Mixer Screens

---

The Audio Mixer screen has two tabs; Capture Monitor and Playback Monitor. These tabs display what sources are available for monitoring / mixing via the AJA hardware when in either of those two modes (if applicable). The controls on this screen are dedicated only to monitoring adjustments, and do not affect the level at which inbound audio signals are captured to storage.

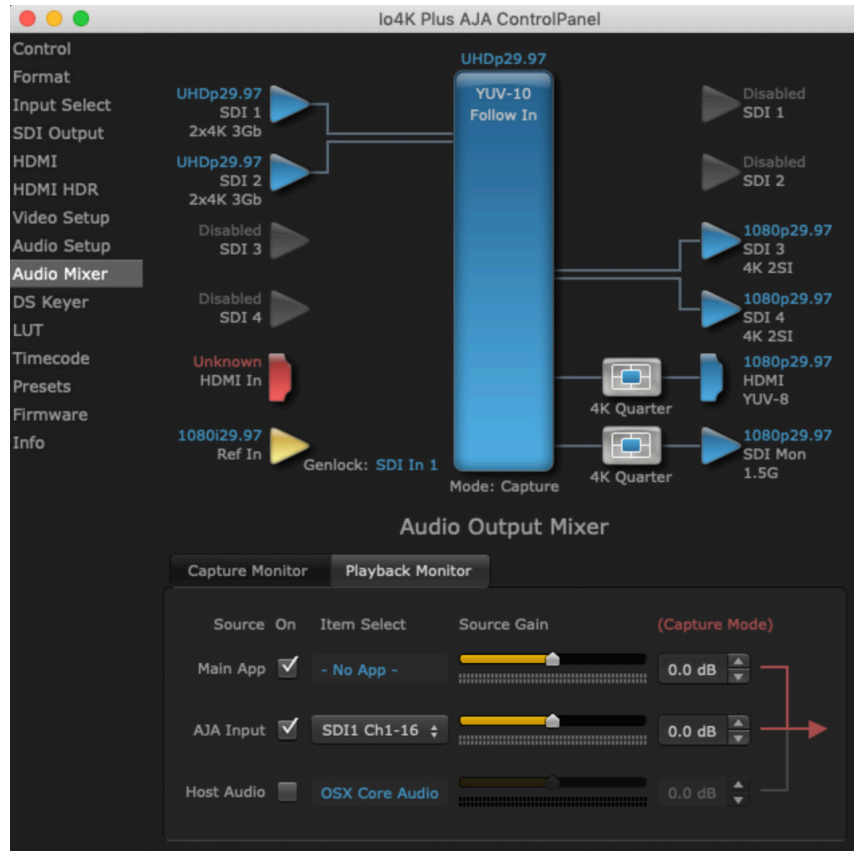
The selection check boxes and screen slider controls affect the following Io 4K Plus outputs:

- SDI Embedded Audio Out
- HDMI Embedded Audio Out
- Analog Audio Out (via DB25 cable)
- Front Panel Monitor Out (headphone jack) - This level can also be adjusted with the front panel gain knob, and is additive to the screen slider controls.

*IMPORTANT: Even though you can hear changes in the signals and levels adjusted with the Audio Mixer screen, these changes are NOT recorded to disk during NLE Capture or Audio Punch In / Voice Over to Timeline. In addition, muting or activating sources on this screen will not affect audio signals being recorded. The Audio Mixer screen is dedicated for monitoring only, not program mixing.*

The branching arrow on the lower right indicates which sources are being routed for monitoring in that operating mode, and is colored blue when active and red when disabled.

Figure 9. Audio Mixer Screen Example



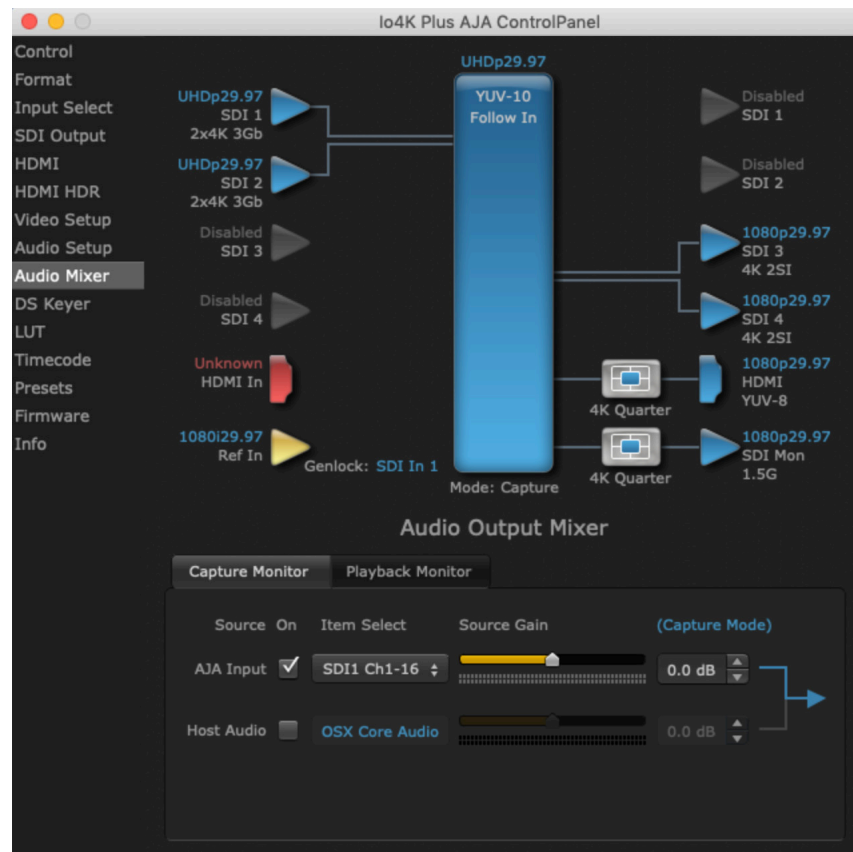
Each source has a confidence meter, which enables you to tell immediately if you have a source arriving correctly at the AJA hardware (without having to launch any other software). The level sliders allow a simple plus or minus adjustment to the Source level being monitored. This is to allow for fine-tuning of your listening environment (on occasions the host system audio can be unexpectedly loud, or an incoming feed may be very loud or very quiet).

Two different Audio Mixer screens are available, selected by clicking on the Playback Monitor or Capture Monitor tabs. During regular editing, the Playback tab is used to control your monitoring experience. During capture operations, the Capture tab is used for your monitoring experience.

Controls in each tab are only in effect when lo 4K Plus is in the correct operating mode, as determined by the controlling application or the Control Panel application's Default Output setting. When the mode doesn't match, the mode indicator on the right goes red (see [Figure 9 on page 37](#)). However, settings can be adjusted while in that disabled mode, and will be applied when you return to that operating mode.

## Audio Mixer Capture Monitor Mode Screen

Figure 10. Audio Mixer Screen, Capture Monitor Mode



The Capture Monitor Mode screen is used to select and mix audio to be monitored during capture operations.

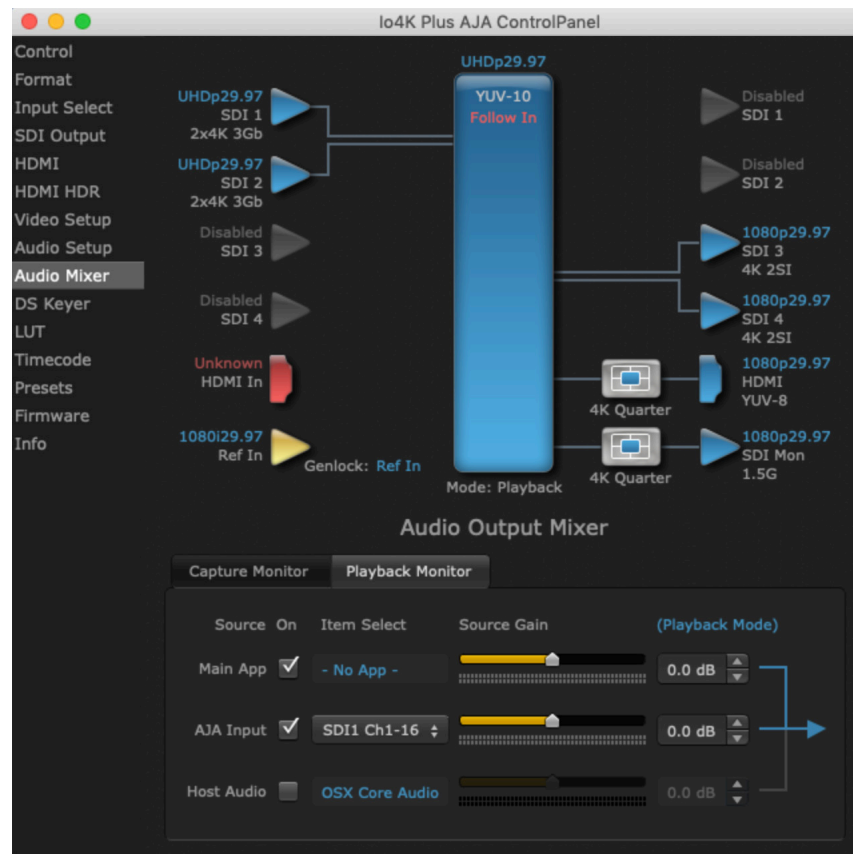
**IMPORTANT:** Even though you can hear changes in the signals and levels adjusted with the Audio Mixer screen, these changes are NOT recorded to disk during NLE Capture or Audio Punch In / Voice Over to Timeline. In addition, muting or activating sources on this screen will not affect audio signals being recorded. The Audio Mixer screen is dedicated for monitoring only, not program mixing.

The controls on this screen are similar to those on the Playback Monitor Mode screen, except the Main App is not available for selection (you cannot capture from the application that is capturing). See ["Audio Mixer Playback Monitor Mode Screen" on page 39](#) for more information.

**NOTE:** If you want different behavior when the Capture tab is triggered; i.e. for host system audio to be muted, then simply check the host system audio in the Capture tab only. This way when you exit NLE Capture and return to regular editing, the Playback tab settings will be applied and your host system audio monitoring will resume.

## Audio Mixer Playback Monitor Mode Screen

Figure 11. Audio Mixer Screen, Playback Monitor Mode



### Playback Source Selection

Clicking the **On** checkbox selects the audio for that item for playback to the audio monitor outputs. Multiple sources can be selected simultaneously.

#### Main App

If an external application is controlling the lo 4K Plus, it will be displayed in the **Item Select** column and its audio can be selected for playback with the checkbox.

#### AJA Input

Selects for monitoring the audio being input to lo 4K Plus.

**NOTE:** The **AJA Input Item Select** dropdown selection is linked to the **Input Select** screen's **Audio Input Select** dropdown. Changing the setting on one screen will also change the setting on the other screen.

In the **Item Select** column, click on the dropdown and choose from:

- Analog - The Analog Audio being received on the lo 4K Plus, DB-25 connector.
- HDMI - The embedded audio being received on the lo 4K Plus HDMI In connector.
- SDI Ch 1-16 - The embedded audio being received on the lo 4K Plus SDI In connectors.

## Host Audio

---

Selects the audio from the host computer, thus enabling the AJA hardware to monitor anything that would normally be presented via the host laptop, CPU or computer monitor. For example, an editor could sample music from an online library, while concurrently playing back their NLE timeline. Or, a producer and editor could be communicating live during an editing session, using Skype or some other video calling tool.

## Source Gain

---

Meters display the input audio levels of the source, colored green when that source is On, and gray when that source is not selected. The levels shown do not change when the gain is adjusted, because the input levels are being monitored, not the output levels.

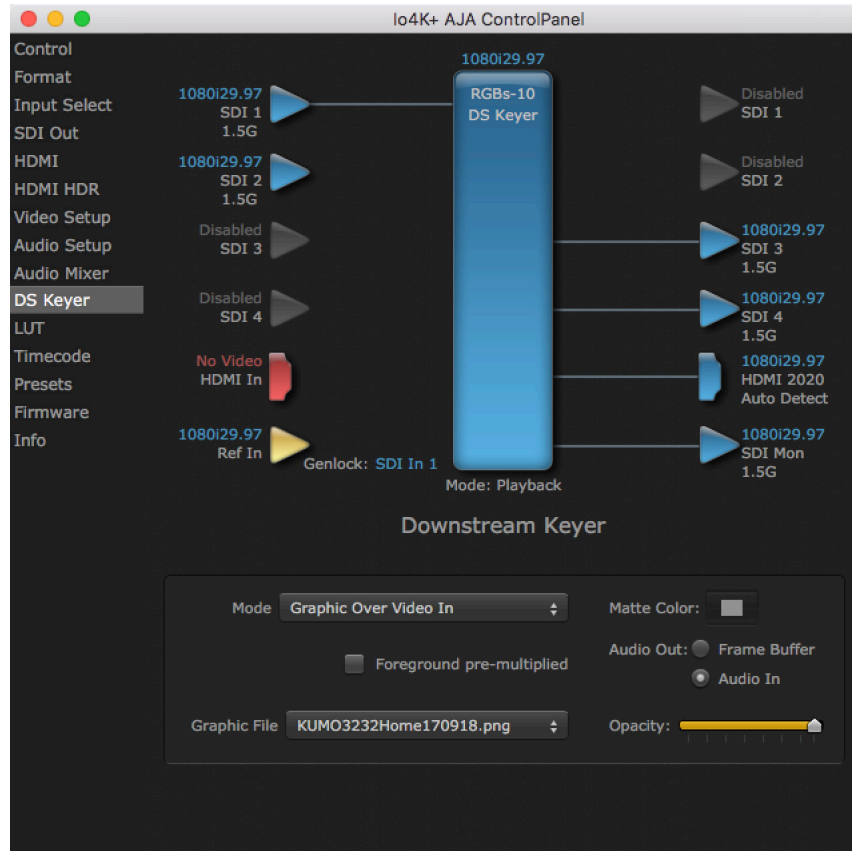
When activated, the source gain controls can be used to adjust the monitoring output gain of that source, from +6dB to - infinity (mute). Adjustment methods include:

- Sliders - The sliders on the right can be used to change the values for each color.
- Numeric Entry - You also enter a numeric value by clicking on the displayed number, and can increase or decrease the values clicking on the up/down arrow boxes.
- Cut and Paste - Right clicking on a displayed number opens a Cut, Copy, Paste dropdown menu for convenient numeric entry.

As mentioned before, these controls are for monitoring only, and do not change the audio recorded to a NLE file. Any actual recording level adjustments to Capture or Audio Punch In / Voice Over to Timeline operations will either need to be made upstream of the AJA input, or else via adjustments within the main NLE application (e.g. via a pass through mix tool) .



## DS Keyer Screen



The lo 4K Plus has a hardware-based downstream keyer that is ideal for putting logos, “bugs” or other video material with an alpha channel on top of video being played out or printed to tape.

*NOTE: The lo 4K Plus does not support Downstream Keying in UltraHD and 4K formats.*

A typical application would be putting a television station’s call letters or channel over program video content. Keyed video can be from the lo 4K Plus internal Frame Buffer (from storage, video In, etc.) or from a graphics file that has an alpha channel (Photoshop etc.).

Settings in the DS Keyer Screen provide control over how the keyer operates and whether it’s turned on or off.

## Mode

---

Downstream Keyer Off - When this pulldown menu item is selected the downstream keyer will be turned off

- Frame Buffer over Matte - Places the keyed video with alpha channel currently in the Frame Buffer over a fixed color matte determined by the "Matte Color" setting set separately.
- Frame Buffer over Video In - Places the keyed video currently in the Frame Buffer over the video input for playout or print-to-tape.
- Graphic over Matte - Places a graphics file having an alpha channel (chosen in "Graphic File" pulldown) over a fixed color matte determined by the "Matte Color" setting set separately.
- Graphic over Video In - Places a graphics file having an alpha channel (chosen in "Graphic File" pulldown) over the video input for playout or print-to-tape.
- Graphic over Frame Buffer - Places a graphics file having an alpha channel (chosen in "Graphic File" pulldown) over the current contents of the lo 4K Plus Frame Buffer (which might be from storage, video In, etc.).

## Matte Color

---

Only available when the pulldown "Frame Buffer over Matte" or "Graphic over Matte" are selected-pressing this button brings up a color selection dialog. The dialog provides a variety of ways to select a matte color including a color wheel, color picker (choose from a location anywhere on the computer screen), numeric sliders, swatches, "crayons", and spectrums. The matte chosen will be used as a video background under the keyed video.

## Foreground pre-multiplied (checkbox)

---

Use to avoid "matte lines" and improve the appearance of the foreground (key) being composited over the background.

## Audio Out

---

- Frame Buffer - Select audio out to be routed from the Frame Buffer.
- Audio In - Select audio out to be routed from the lo 4K Plus's selected input(s).

## Graphic File

---

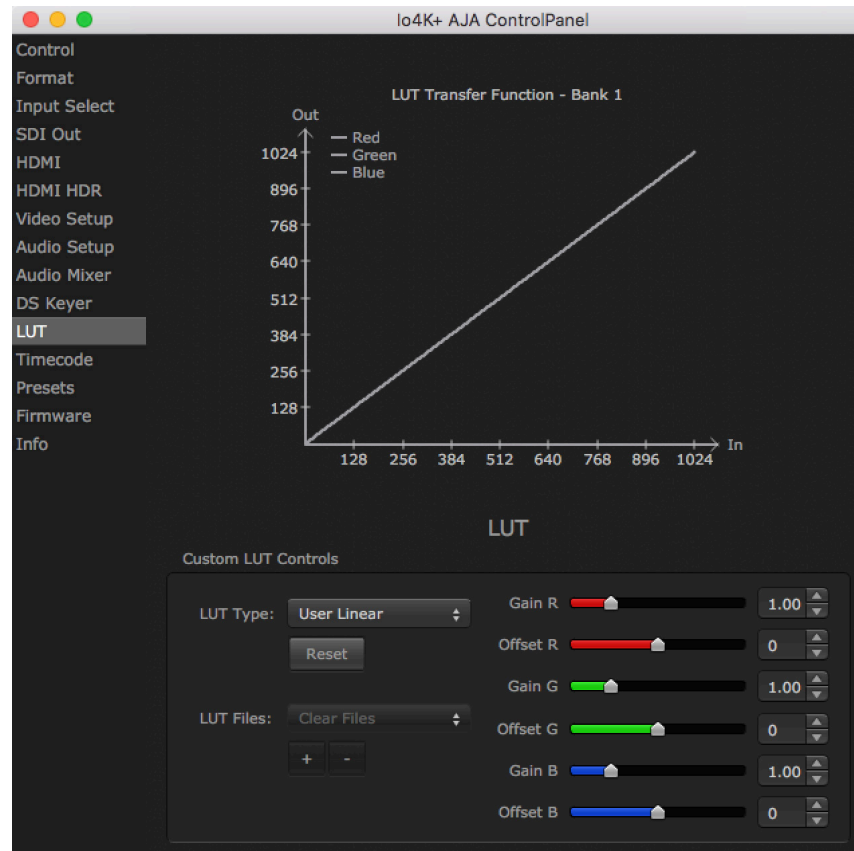
This pulldown allows you to choose from any recently accessed file or select a new file ("Load File..."), which then brings up a file dialogue. You can load any standard RGB graphics file (.tif,.psd, etc.) into the frame buffer for display, but some graphics formats and bit depths may not be supported.

The file raster (pixel x pixel count) should match the primary format in the frame buffer or the secondary format if up-converting. For example, you wish to key a logo on top of a 1920x1080 footage, the still image with alpha channel that you load should be 1920x1080.

Loaded graphic files are retained for redisplay if another file is chosen, and even if the lo 4K Plus is power cycled.

**NOTE:** *A loaded graphics file will not be scaled to fit. If it's smaller than the current frame buffer format, lo 4K Plus will center it in the frame. If larger than the current frame buffer format it will be cropped.*

## LUT Screen



The LUT screen controls allow you to create a custom color look up table (LUT) on the output, for matching a production "look" on a specific display.

Users can also specify their own custom LUTs by creating a LUT file and uploading it to an AJA Video Device using the LUT (lookup table) screen in the Control Panel.

## Custom LUT Controls

The LUT Transfer Function screen displays an approximate representation of the effect of the current LUT settings. When the controls are activated by selecting a User LUT Type, Red, Blue, and Green curves show the transfer functions of each color.

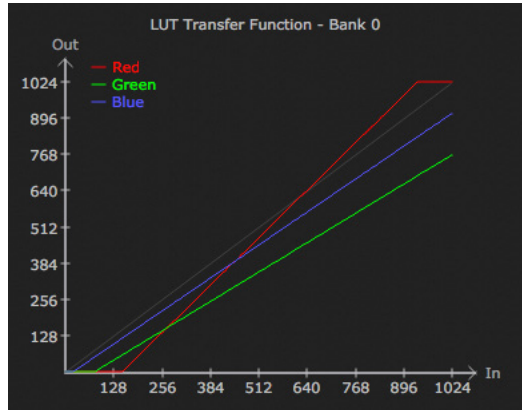
*NOTE: The displayed curves are approximate. Curves for some extreme settings may diverge significantly from the actual transfer functions.*

### LUT Type

Selects the type of LUT. Choose from

- Auto - LUT will be automatically selected. This setting intelligently applies the type of LUT required in the majority of use cases. For example, if the Frame Buffer is set to SD 608 and the Output set to HD 709, then an industry standard curve for changing 608 to 709 color space is applied.
- Linear - A linear 1:1 LUT is applied, resulting in no color change (every value for source is mapped to the same value for output).
- SMPTE->FullRange - A conversion LUT from SMPTE to Full Range is applied.
- FullRange->SMPTE - A conversion LUT from Full Range to SMPTE is applied.
- User Linear - Activates the Gain and Offset controls, allowing the manual creation of a custom LUT. Initial default setting is linear.

Figure 12. Example LUT Transfer Function Curves



- User Film Stream - Activates the Gain and Offset controls with a default curve matching Grass Valley FilmStream cameras, and also allowing manual creation of a custom LUT.
- User LUT File - See "[LUT Files](#)" below.

### Gain and Offset Controls

---

When activated, the controls on the right allow adjustment of Gain and Offset for Red, Blue and Green.

- Sliders - The sliders on the right can be used to change the values for each color.
- Numeric Entry - You also enter a numeric value by clicking on the displayed number, and can increase or decrease the values clicking on the up/down arrow boxes.
- Cut and Paste - Right clicking on a displayed number opens a Cut, Copy, Paste dropdown menu for convenient numeric entry.

### Reset

---

Clicking on the Reset button resets the currently selected LUT Type to its default values (not active for a User LUT file).

### LUT Files

---

The User LUT File setting above activates the LUT Files dropdown, allowing the selection of a previously saved LUT file. You can create a custom LUT file using most text editors or spread sheets, provided the data is arranged according to the LUT File Format Specification that follows (see "[LUT File Format Specification](#)" on [page 45](#)).

### Uploading Custom User LUT file

---

Once the LUT file is created, you can upload it with the following steps:

1. Before loading a LUT, make sure you are using an RGB/RGBA frame buffer format, and that you have a AJA Video Device that supports LUTs.
2. Open AJA Control Panel and select the "LUT" pane.
3. Click the "LUT Type" popup and choose "User LUT File" menu item. Note "LUT Files" options become enabled.
4. Click the "+" button and use the navigation dialog to choose a custom LUT file. The LUT is now loaded.

## LUT File Format Specification

LUT files are normal text files that contain 1025 lines (numbered 0 - 1024). Each line contains 3 integer values in the range 0 - 1023, representing 10 bit R, G, B component output values. Component values may be separated by one or more commas, spaces, or tabs. The example below show LUT File contents for Line 0, Line 1, Line 2, and Line 1024, with several valid ways to separate the numbers in a line.

- 16, 17, 17
- 17 18 18
- 19 19 21
- ...
- 1000, 1022, 1023

In the example above, the first line (Line 0) represents the output values for the case where R=0, G=0, or B=0. In other words, if the R component of a pixel is set to 0, then set R component value to 16. Likewise, if G is set to 0, then set G to 17. The second line (Line 1) does a similar thing for input component values equal to 1.

A simple way to construct a LUT file is to use a Spreadsheet like Excel. Simply fill 3 columns and 1025 rows with LUT data, and save the result as a "CSV" file.

## Timecode Screen



The Timecode screen is used to select the timecode stream read for applications that use it (for example, in AJA Control Room when the Timecode Source preference is set to "Control Panel Setting" that application will read the selected stream). This screen is also used for monitoring the RP-188 timecode embedded in the digital data stream, for selecting a timecode offset (if required), and setting timecode outputs.

## Options

---

### Source

---

In RP-188 timecode (SMPTE 12M-gg2) there can be multiple timecode types in the data stream. Use this pull-down to select the one you wish to monitor:

- RP188 LTC (Linear timecode)
- RP188 VITC (Vertical Interval timecode)
- LTC Port

The selection will be displayed in the timecode value displayed to the right of the pull-down.

*NOTE: SMPTE RP 188 defines a standard for the transmission of time code and control code in the ancillary data space of a digital television data stream. Time code information is transmitted in the ancillary data space as defined in ANSI/SMPTE 291M. Multiple codes can be transmitted within a single digital video data stream. Other time information, such as real time clock, DTTR tape timer information, and other user-defined information, may also be carried in the ancillary time code packet instead of time code. The actual information transmitted through the interface is identified by the coding of a distributed binary bit. Equipment manufacturers can use the meta data for different purposes.*

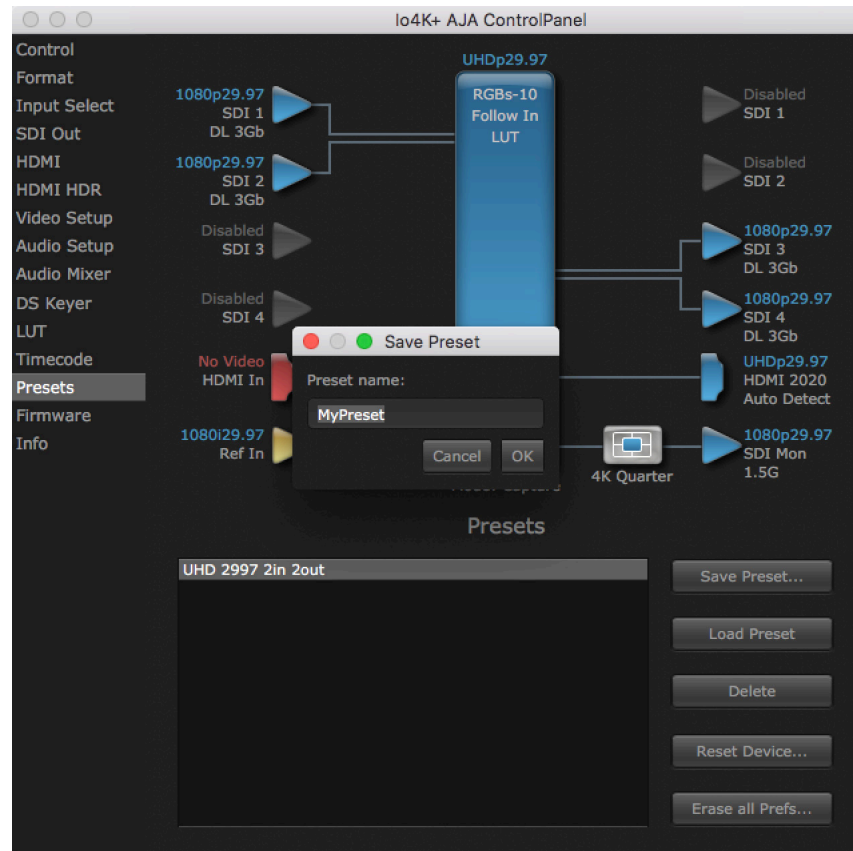
### User Bits

---

For monitoring a variable framerate (VFR) timecode (such as Varicam), you may wish to check the User-bits box. If you set this checkbox, Io 4K Plus will detect and interpret the user-bits and display them next to the checkbox. You will see the original framerate (30 fps in the figure below) followed by the adjusted frame padding (two digits reporting discarded and retained frame padding).

*NOTE: SMPTE 12M-2 is the updated name and specification for what was RP-188.*

## Presets Screen



After configuring the AJA Control Panel screens, you can then save all your settings as a snapshot for later recall, called a preset. In this way, you can organize presets for all your typical tasks, eliminating manual reconfiguration.

## Saving, Loading and Deleting Presets

To save a preset, simply go to the Presets screen and click "Save Preset". A dialog will be presented asking you for a file name. Enter a meaningful name and click "OK". Thereafter the preset will be available under the Control Panel "Presets" list.

From the Presets screen you can manage your collection of presets easily. To Load or Delete a stored preset, just select it with your mouse and then click the "Load Preset" or "Delete" button respectively .

## Transferring Saved Presets

If you want to use a saved Preset on another workstation, you can simply copy the file on removable storage and install it at the new location. The Preset files are stored at:

### Mac OS Preset Files Storage Location

- From the Finder, hold down the Option key (to display the Library directory) and click on Go/Library/Application Support/AJA/<device name>/Presets/

### Windows Preset Files Storage Location

- c:\Users\<username>\AppData\Local\AJA\Control Panel\<device name> Presets\

## Reset to Default

When you click the "Reset Device" button the Default User Preference file will be deleted and AJA Control Panel will do one of the following:

- If a Default Global Preference is found, it is loaded and the device is set to this state.
- If a Default Global Preference file is not found, "factory defaults" are loaded and the device is set to this state.

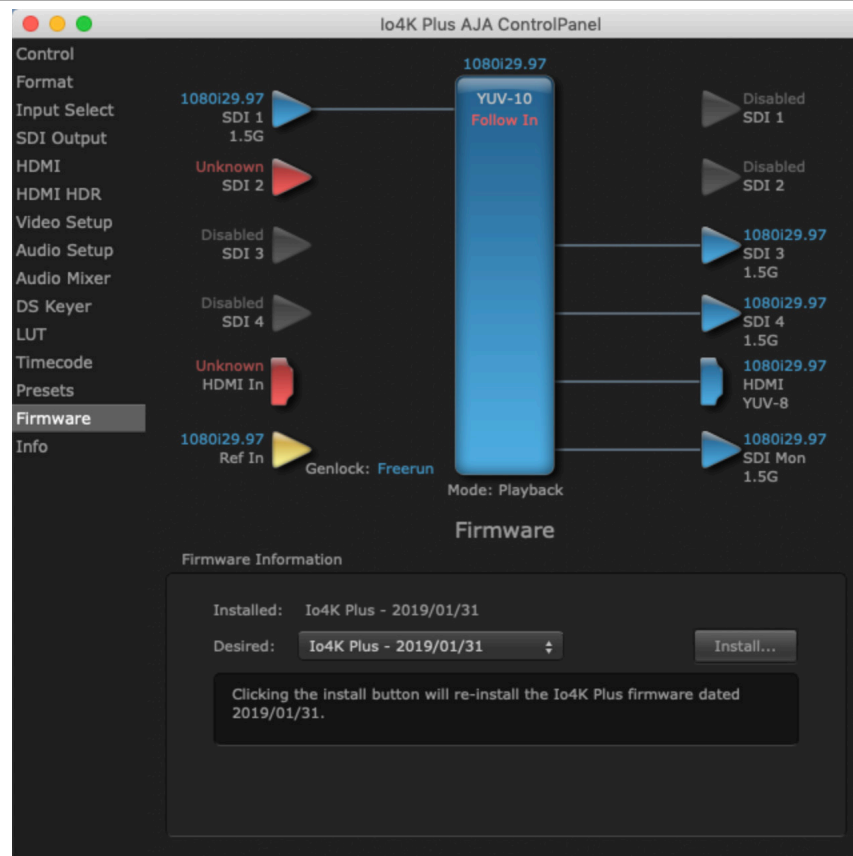
*NOTE: See "Default Preferences" on page 16 for more information.*

## Erase all Prefs

For technical support purposes you may be required to remove the current Preference settings. Clicking on the "Erase all Prefs" button deletes the current Default User Preference file without accessing a Default Global Preference file, if one exists. Current AJA device settings are not altered, but changing any setting will immediately regenerate a Default User Preference file with the changed settings.

*NOTE: Clicking on the AJA Control Panel Erase All Prefs button does NOT delete an existing Global Preference file from that shared location.*

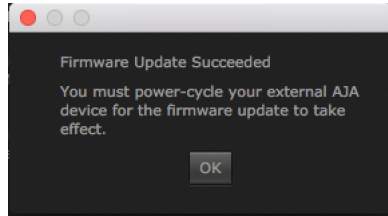
## Firmware Screen



Use the Firmware screen to access the firmware install screen. Click install to erase current firmware and load the firmware version contained in your current driver installation. Note the Installation message shown below.

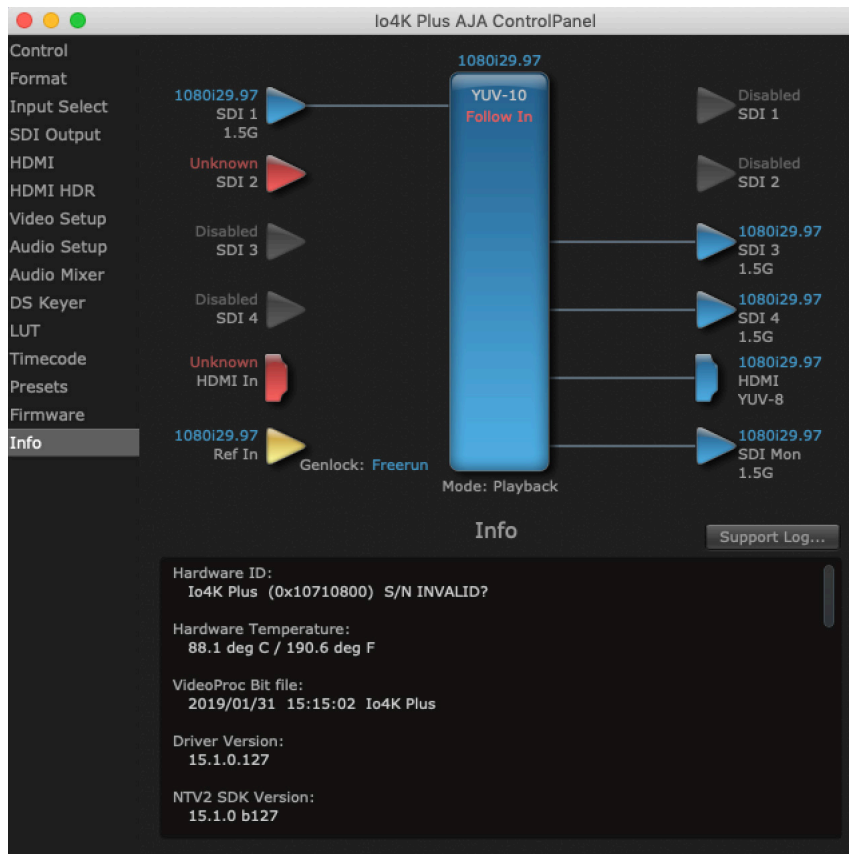


Figure 13. Update Completed



You will be required to power-cycle your Io 4K Plus and computer to finish the update.

## Info Screen



The Info Screen shows the software files that have been installed on your system. This information may be needed if you talk to an AJA Customer Service representative to determine if files are missing or need updating.

# Appendix A – Specifications

---

## 10 4K Plus Tech Specs

---

### Video Formats

---

- (4K) 4096 x 2160P 23.98, 24, 25, 29.97, 30, 47.95, 48, 50, 59.94, 60
- (UltraHD) 3840 x 2160P 23.98, 24, 25, 29.97, 30, 50, 59.94, 60
- (2K) 2048 x 1080p 23.98, 24, 25, 29.97, 30, 47.95, 48, 50, 59.94, 60
- (2K) 2048 x 1080PsF 23.98, 24, 25, 29.97, 30
- (HD) 1080p 23.98, 24, 25, 29.97, 30, 50, 59.94, 60
- (HD) 1080PsF 23.98, 24, 25, 29.97, 30
- (HD) 1080i 50, 59.94, 60
- (HD) 720p 50, 59.94, 60
- (SD) 625i 50
- (SD) 525i 59.94

Note: High Frame Rate capabilities are dependent on host system attributes. Not all systems and configurations will support all frame rates.

### Video Inputs

---

- 12G-SDI\*, SMPTE-2082, 12-bit\*\*, 10-bit and 8-bit
- 6G-SDI\*, SMPTE-2081, 10-bit and 8-bit
- 3G-SDI, SMPTE-259/292/296/424/425, 12-bit\*, 10-bit and 8-bit
- 4K/UltraHD 4:4:4 (4x BNC)
- 1.5G-SDI, SMPTE 372M, Dual Link HD 4:4:4 (2x BNC), 12-bit\*\*, 10-bit and 8-bit
- 1.5G-SDI, SMPTE 292M, Single Link 4:2:2 (1x BNC), 10-bit and 8-bit
- HDMI v2.0
- 30/36-bits/pixel, RGB or YUV, 6 Gbps per color component
- 4K, UltraHD, 2K, HD and SD with HFR support up to 60p (4:2:2), 10-bit and 8-bit

\*SDI connections are bidirectional. For 2K/HD, capture and monitoring can be simultaneous. For 4K/UltraHD with 12G-SDI, capture and monitoring can also be simultaneous. For 4K/UltraHD with 3G-SDI, all four connections must be used for either Input or Output. Additionally, 12G-SDI, 6G-SDI configured inputs support UltraHD / 4K only.

\*\*Bit depth support is application dependent. Check with your software manufacturer for compatibility.

### Video Outputs

---

- 12G-SDI\*, SMPTE-2082, 12-bit\*\*, 10-bit and 8-bit
- 6G-SDI\*, SMPTE-2081, 10-bit and 8-bit
- 3G-SDI, SMPTE-259/292/296/424, 12-bit\*, 10-bit and 8-bit
- 4K/UltraHD 4:4:4 (4x BNC)
- 1.5G-SDI, SMPTE 372M, Dual Link HD 4:4:4 (2x BNC), 12-bit\*\*, 10-bit and 8-bit
- 1.5G-SDI, SMPTE 292M, Single Link 4:2:2 (1x BNC), 10-bit and 8-bit
- HDMI v2.0
- 30/36 bits/pixel, RGB or YUV, 6 Gbps per color component
- 4K, UltraHD, 2K, HD and SD with HFR support up to 60p (4:2:2), 10-bit and 8-bit
- HDR10 Support - HDR Infoframe metadata, compatible with HDMI 2.0a/CTA-861.3
- HLG Support - compatible with HDMI 2.0b/CTA-861-G\*\*\*

\*SDI connections are bidirectional. For 2K/HD, capture and monitoring can be simultaneous. For 4K/UltraHD with 12G-SDI, capture and monitoring can also be simultaneous. For 4K/UltraHD with 3G-SDI, all four connections must be used for either Input or Output. Additionally, 12G-SDI, 6G-SDI configured outputs support UltraHD / 4K only.

\*\*Bit depth support is application dependent. Check with your software manufacturer for compatibility.

\*\*\*HLG support is application dependent. Check with your software manufacturer for compatibility.

## Audio Inputs Digital

---

- 16-Channel, 24- and 16-bit SDI embedded audio, 48 kHz sample rate, synchronous
- 8-Channel, 24- and 16-bit HDMI embedded audio, 48 kHz sample rate, synchronous

## Audio Inputs Analog

---

- 8-Channel, 24 and 16-bit D/A analog audio, 48 kHz sample rate, balanced, using industry standard 8x XLR on DB-25 breakout cable (cable not included)
- +24 dBu full scale digital (0 dBFS)
- +/- 0.2 dB 20 to 20 kHz frequency response
- Input supported across Ch 1-8, Ch 1-4, or Ch 5-8 depending on configuration chosen

## Audio Outputs Digital

---

- 16-Channel, 24-bit SDI embedded audio, 48 kHz sample rate, synchronous
- 8-Channel, 24-bit HDMI embedded audio, 48 kHz sample rate, synchronous

## Audio Outputs Analog

---

- 8-Channel, 24-bit D/A analog audio, 48 kHz sample rate, balanced, using industry standard 8x XLR on DB-25 breakout cable (cable not included)
- +24 dBu full scale digital (0 dBFS)
- +/- 0.2 dB 20 to 20 kHz frequency response
- Output supported across Ch 1-8, Ch 1-4, or Ch 5-8 depending on configuration chosen

## Downstream Keyer

---

- Supports graphics with alpha channel over video, matte or framebuffer, or framebuffer content over incoming video or matte

## Down-Conversion 4K/UltraHD

---

- Real time, dedicated 4K down-conversion output (1x BNC)
- 4K to 2K down-conversion
- UltraHD to HD down-conversion

## Reference and LTC I/O

---

- 1x BNC LTC output
- 1x BNC assignable to Reference video or LTC input

## Reference

---

- Analog Color Black (1V) or Composite Sync (2 or 4V) or HD Tri-Level Sync (1V)
- Reference input is terminated into 75 ohms when Genlock is set to Ref In

## Electrical Interface

---

- Thunderbolt 3 (2x)

## Machine Control

---

- RS-422, Sony 9-pin protocol
- 9-pin D-connector pinout is as follows:
  - 1 GND
  - 2 RX-
  - 3 TX+
  - 4 GND
  - 5 No Connection
  - 6 GND
  - 7 RX+
  - 8 TX-
  - 9 GND
- Shell GND

## Size (w x d x h)

---

- 8.74" x 8.11" x 1.65" (222.0 mm x 206.0 mm x 41.9 mm)

## Weight

---

- 3.4 lbs (1.6 kg)

## Power (device only)

---

- 10-20V, 30W typical, 36W max, 70W max with USB-C power delivery to external devices

## Environment

---

- Safe Operating Temperature Range: 0 to 40 C (32 F to 104 F)
- Safe Storage Temperature (Power OFF): -40 to 60 C (-40 to 140 F)
- Operating Relative Humidity: 10-90% noncondensing
- Operating Altitude: <3,000 meters (<10,000 feet)

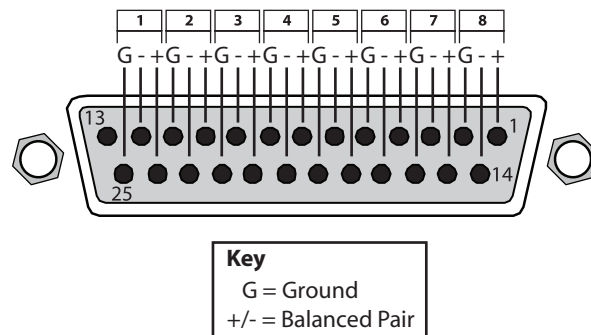
# Audio Connection Pinouts

---

## Analog Audio

---

Figure 14. DB-25 Analog Audio Connector Pinouts



# Appendix B – Safety and Compliance

---

## Federal Communications Commission (FCC) Compliance Notices

---

### Class A Interference Statement

---

This equipment has been tested and found to comply with the limits for a Class A digital device, pursuant to Part 15, Subpart B of the FCC Rules. These limits are designed to provide reasonable protection against harmful interference in a residential installation. This equipment generates, uses, and can radiate radio frequency energy and, if not installed and used in accordance with the instructions, may cause harmful interference to radio communications. However, there is no guarantee that interference will not occur in a particular installation. If this equipment does cause harmful interference to radio or television reception, which can be determined by turning the equipment off and on, the user is encouraged to try to correct the interference by one or more of the following measures:

- Reorient or relocate the receiving antenna.
- Increase the separation between the equipment and receiver.
- Connect the equipment into an outlet on a circuit different from that to which the receiver is connected.
- Consult the dealer or an experienced radio/TV technician for help.

### FCC Caution

---

This device complies with Part 15 of the FCC Rules. Operation is subject to the following two conditions: (1) This device may not cause harmful interference, and (2) this device must accept any interference received, including interference that may cause undesired operation.

## Canadian ICES Statement

---

### Canadian Department of Communications Radio Interference Regulations

This digital apparatus does not exceed the Class A limits for radio-noise emissions from a digital apparatus as set out in the Radio Interference Regulations of the Canadian Department of Communications. This Class A digital apparatus complies with Canadian ICES-003.

### Règlement sur le brouillage radioélectrique du ministère des Communications

Cet appareil numérique respecte les limites de bruits radioélectriques visant les appareils numériques de classe A prescrites dans le Règlement sur le brouillage radioélectrique du ministère des Communications du Canada. Cet appareil numérique de la Classe A est conforme à la norme NMB-003 du Canada.

## European Union and European Free Trade Association (EFTA) Regulatory Compliance

---

This equipment may be operated in the countries that comprise the member countries of the European Union and the European Free Trade Association. These countries, listed in the following paragraph, are referred to as The European Community throughout this document:

AUSTRIA, BELGIUM, BULGARIA, CYPRUS, CZECH REPUBLIC, DENMARK, ESTONIA, FINLAND, FRANCE, GERMANY, GREECE, HUNGARY, IRELAND, ITALY, LATVIA, LITHUANIA, LUXEMBOURG, MALTA, NETHERLANDS, POLAND, PORTUGAL, ROMANIA, SLOVAKIA, SLOVENIA, SPAIN, SWEDEN, UNITED KINGDOM, ICELAND, LICHTENSTEIN, NORWAY, SWITZERLAND

## Declaration of Conformity

Marking by this symbol indicates compliance with the Essential Requirements of the EMC Directive of the European Union 2014/30/EU.



This equipment meets the following conformance standards:

This equipment meets the following conformance standards:

### Safety

EN 60065: 2014 (T-Mark License),

IEC 60065: 2014, (CB Scheme Report/Certificate)

Additional licenses issued for specific countries available on request.

### Emissions

EN 55032: 2012 + AC: 2013, CISPR 32: 2015

EN 61000-3-2: 2014, EN 61000-3-3: 2013

### Immunity

EN 55103-2: 2009

61000-4-2: 2009, EN 61000-4-3: 2006 + A1: 2008 + A2: 2010,

EN 61000-4-4: 2004 + A1: 2010, EN 61000-4-5: 2006,

EN 61000-4-6: 2009, EN 61000-4-11: 2004

Environments: E2, E3 and E4

The product is also licensed for additional country specific standards as required for the International Marketplace.



**Warning!** This is a Class A product. In a domestic environment, this product may cause radio interference, in which case, the user may be required to take appropriate measures.

**Achtung!** Dieses ist ein Gerät der Funkstörgrenzwertklasse A. In Wohnbereichen können bei Betrieb dieses Gerätes Rundfunkstörungen auftreten, in welchen Fällen der Benutzer für entsprechende Gegenmaßnahmen verantwortlich ist.

**Attention!** Ceci est un produit de Classe A. Dans un environnement domestique, ce produit risque de créer des interférences radioélectriques, il appartiendra alors à l'utilisateur de prendre les mesures spécifiques appropriées..

## Recycling Notice



This symbol on the product or its packaging indicates that this product must not be disposed of with your other household waste. Instead, it is your responsibility to dispose of your waste equipment by handing it over to a designated collection point for the recycling of waste electrical and electronic equipment. The separate collection and recycling of your waste equipment at the time of disposal will help conserve natural resources and ensure that it is recycled in a manner that protects human health and the environment. For more information about where you can drop off your waste for recycling, please contact your local authority, or where you purchased your product.

## Korea KCC Compliance Statement

A급 기기 (업무용 방송통신기자재)	이 기기는 업무용(A급) 전자파적합기기로서 판매자 또는 사용자는 이 점을 주의하시기 바라며, 가정외의 지역에서 사용하는 것을 목적으로 합니다.
Class A (Broadcasting Communication Equipment for Office Use)	As an electromagnetic wave equipment for office use (Class A), this equipment is intended to use in other than home area. Sellers or users need to take note of this.

## Taiwan Compliance Statement

**警告使用者：**  
這是甲類的資訊產品，在居住的環境中使用時，可能會造成射頻干擾，在這種情況下，使用者會被要求採取某些適當的對策。

This is a Class A product based on the standard of the Bureau of Standards, Metrology and Inspection (BSMI) CNS 13438, Class A. In a domestic environment this product may cause radio interference in which case the user may be required to take adequate measures.

## Japan Compliance Statement

この装置は、クラスA情報技術装置です。この装置を家庭環境で使用すると電波妨害を引き起こすことがあります。この場合には使用者が適切な対策を講ずるよう要求されることがあります。 VCCI-A

This is a Class A product based on the standard of the VCCI Council (VCCI 32: 2016). If this equipment is used in a domestic environment, radio interference may occur, in which case, the user may be required to take corrective actions.

## China Compliance Statement

This product has been tested to the following Chinese standards:

GB/T13837-2012, GB8898-2011, and GB17625.1-2012

This product meets the requirements of implementation rules for compulsory certification (REF NO. CNCA-C08-01:2014) under certificate number 2018010805038172.

## Translated Warning and Caution Messages

The following caution statements, warning conventions, and warning messages apply to this product and manual.



Warning Symbol



Caution Symbol

## Before Operation Please Read These Instructions



**Warning!** Read and follow all warning notices and instructions marked on the product or included in the documentation.

**Avertissement!** Lisez et conformez-vous à tous les avis et instructions d'avertissement indiqués sur le produit ou dans la documentation.

**Warnung!** Lesen und befolgen Sie die Warnhinweise und Anweisungen, die auf dem Produkt angebracht oder in der Dokumentation enthalten sind.

**¡Advertencia!** Lea y siga todas las instrucciones y advertencias marcadas en el producto o incluidas en la documentación.

**Aviso!** Leia e siga todos os avisos e instruções assinalados no produto ou incluídos na documentação.

**Avviso!** Leggere e seguire tutti gli avvisi e le istruzioni presenti sul prodotto o inclusi nella documentazione.



**Warning!** Do not use this device near water and clean only with a dry cloth.

**Avertissement!** N'utilisez pas cet appareil près de l'eau et nettoyez-le seulement avec un tissu sec.

**Warnung!** Das Gerät nicht in der Nähe von Wasser verwenden und nur mit einem trockenen Tuch säubern.

**¡Advertencia!** No utilice este dispositivo cerca del agua y límpielo solamente con un paño seco.

**Aviso!** Não utilize este dispositivo perto da água e limpe-o somente com um pano seco.

**Avviso!** Non utilizzare questo dispositivo vicino all'acqua e pulirlo soltanto con un panno asciutto.



**Warning!** Do not block any ventilation openings. Install in accordance with the manufacturer's instructions.

**Avertissement!** Ne bloquez aucune ouverture de ventilation. Suivez les instructions du fabricant lors de l'installation.

**Warnung!** Die Lüftungsöffnungen dürfen nicht blockiert werden. Nur gemäß den Anweisungen des Herstellers installieren.

**¡Advertencia!** No bloquee ninguna de las aberturas de la ventilación. Instale de acuerdo con las instrucciones del fabricante.

**Aviso!** Não obstrua nenhuma das aberturas de ventilação. Instale de acordo com as instruções do fabricante.

**Avviso!** Non ostruire le aperture di ventilazione. Installare in conformità con le istruzioni del fornitore.



**Warning!** Do not install near any heat sources such as radiators, heat registers, stoves, or other apparatus (including amplifiers) that produce heat.

**Avertissement!** N'installez pas l'appareil près d'une source de chaleur telle que des radiateurs, des bouches d'air de chauffage, des fourneaux ou d'autres appareils (amplificateurs compris) qui produisent de la chaleur.

**Warnung!** Nicht in der Nähe von Wärmequellen wie Heizkörpern, Heizregistern, Öfen oder anderen Wärme erzeugenden Geräten (einschließlich Verstärkern) aufstellen.

**¡Advertencia!** No instale cerca de fuentes de calor tales como radiadores, registros de calor, estufas u otros aparatos (incluidos amplificadores) que generan calor.

**Aviso!** Não instale perto de nenhuma fonte de calor tal como radiadores, saídas de calor, fogões ou outros aparelhos (incluindo amplificadores) que produzam calor.

**Avviso!** Non installare vicino a fonti di calore come termosifoni, diffusori di aria calda, stufe o altri apparecchi (amplificatori compresi) che emettono calore





**Warning!** Unplug this device during lightning storms or when unused for long periods of time.

**Avertissement!** Débranchez cet appareil pendant les orages avec éclairs ou s'il est inutilisé pendant de longues périodes.

**Warnung!** Das Gerät ist bei Gewitterstürmen oder wenn es über lange Zeiträume ungenutzt bleibt vom Netz zu trennen.

**¡Advertencia!** Desenchufe este dispositivo durante tormentas eléctricas o cuando no se lo utilice por largos periodos del tiempo.

**Aviso!** Desconecte este dispositivo da tomada durante trovoadas ou quando não é utilizado durante longos períodos de tempo.

**Avviso!** Utilizzare soltanto i collegamenti e gli accessori specificati e/o venduti dal produttore, quali il treppiedi e l'esoscheletro.



**Warning!** Do not open the chassis. There are no user-serviceable parts inside. Opening the chassis will void the warranty unless performed by an AJA service center or licensed facility.

**Avertissement!** Ne pas ouvrir le châssis. Aucun élément à l'intérieur du châssis ne peut être réparé par l'utilisateur. La garantie sera annulée si le châssis est ouvert par toute autre personne qu'un technicien d'un centre de service ou d'un établissement agréé AJA.

**Warnung!** Öffnen Sie das Gehäuse nicht. Keine der Geräteteile können vom Benutzer gewartet werden. Durch das Öffnen des Gehäuses wird die Garantie hinfällig, es sei denn, solche Wartungsarbeiten werden in einem AJA-Service-Center oder einem lizenzierten Betrieb vorgenommen.

**¡Advertencia!** No abra el chasis. El interior no contiene piezas reparables por el usuario. El abrir el chasis anulará la garantía a menos que se lo haga en un centro de servicio AJA o en un local autorizado.

**Advertência!** Não abra o chassi. Não há internamente nenhuma peça que permita manutenção pelo usuário. Abrir o chassi anula a garantia, a menos que a abertura seja realizada por uma central de serviços da AJA ou por um local autorizado.

**Avvertenza!** Non aprire lo chassis. All'interno non ci sono parti riparabili dall'utente. L'apertura dello chassis invaliderà la garanzia se non viene effettuata da un centro ufficiale o autorizzato AJA.



**Warning!** Only use attachments and accessories specified and/or sold by the manufacturer.

**Avertissement!** Utilisez seulement les attaches et accessoires spécifiés et/ou vendus par le fabricant.

**Warnung!** Verwenden Sie nur Zusatzgeräte und Zubehör angegeben und / oder verkauft wurde durch den Hersteller.

**¡Advertencia!** Utilice solamente los accesorios y conexiones especificados y/o vendidos por el fabricante.

**Aviso!** Utilize apenas equipamentos/acessórios especificados e/ou vendidos pelo fabricante.

**Avviso!** Utilizzare soltanto i collegamenti e gli accessori specificati e/o venduti dal produttore.



**Warning!** Refer all servicing to qualified service personnel. Servicing is required when the device has been damaged in any way, such as power-supply cord or plug is damaged, liquid has been spilled or objects have fallen into the device, the device has been exposed to rain or moisture, does not operate normally, or has been dropped.

**Avertissement!** Référez-vous au personnel de service qualifié pour tout entretien. L'entretien est exigé quand l'appareil a été endommagé de quelque manière que ce soit, par exemple lorsque le cordon d'alimentation ou la prise sont endommagés, que du liquide a été versé ou des objets sont tombés dans l'appareil, que l'appareil a été exposé à la pluie ou à l'humidité, ne fonctionne pas normalement ou est tombé.

**Warnung!** Das Gerät sollte nur von qualifizierten Fachkräften gewartet werden. Eine Wartung ist fällig, wenn das Gerät in irgendeiner Weise beschädigt wurde, wie bei beschädigtem Netzkabel oder Netzstecker, falls Flüssigkeiten oder Objekte in das Gerät gelangen, das Gerät Regen oder Feuchtigkeit ausgesetzt wurde, nicht ordnungsgemäß funktioniert oder fallen gelassen wurde.

**¡Advertencia!** Consulte al personal calificado por cuestiones de reparación. El servicio de reparación se requiere cuando el dispositivo ha recibido cualquier tipo de daño, por ejemplo cable o espigas dañadas, se ha derramado líquido o se han caído objetos dentro del dispositivo, el dispositivo ha sido expuesto a la lluvia o humedad, o no funciona de modo normal, o se ha caído.

**Aviso!** Remeta todos os serviços de manutenção para o pessoal de assistência qualificado. A prestação de serviços de manutenção é exigida quando o dispositivo foi danificado mediante qualquer forma, como um cabo de alimentação ou ficha que se encontra danificado/a, quando foi derramado líquido ou caíram objectos sobre o dispositivo, quando o dispositivo foi exposto à chuva ou à humidade, quando não funciona normalmente ou quando foi deixado cair.

**Avviso!** Fare riferimento al personale qualificato per tutti gli interventi di assistenza. L'assistenza è necessaria quando il dispositivo è stato danneggiato in qualche modo, ad esempio se il cavo di alimentazione o la spina sono danneggiati, è stato rovesciato del liquido è stato rovesciato o qualche oggetto è caduto nel dispositivo, il dispositivo è stato esposto a pioggia o umidità, non funziona correttamente o è caduto



**Warning!** Do not defeat the safety purpose of the polarized or grounding-type plug. A polarized plug has two blades with one wider than the other. A grounding type plug has two blades and a third grounding prong. The wide blade or the third prong are provided for your safety. If the provided plug does not fit into your outlet, consult an electrician for replacement of the obsolete outlet.

**Avertissement!** La sécurité de la prise polarisée ou de la prise de type mise à la terre ne doit en aucun cas être empêchée de fonctionner. Une prise polarisée a deux broches, l'une étant plus large que l'autre. Une prise de type mise à la terre a deux broches et une troisième broche pour la mise à la terre. La broche large ou la troisième broche sont fournies pour votre sécurité. Si la prise fournie ne s'insère pas dans votre prise femelle, consultez un électricien pour le remplacement de la prise femelle obsolète.

**Warnung!** Der Sicherheitszweck des gepolten bzw. Schukosteckers ist zu berücksichtigen. Ein gepolter Stecker verfügt über zwei Pole, von denen einer breiter als der andere ist. Ein Schukostecker verfügt neben den zwei Polen noch über einen dritten Pol zur Erdung. Der breite Pol bzw. der Erdungspol dienen der Sicherheit. Wenn der zur Verfügung gestellte Stecker nicht in Ihren Anschluss passt, konsultieren Sie einen Elektriker, um den veralteten Anschluss zu ersetzen.

**¡Advertencia!** No eche por tierra la finalidad del tipo de enchufe polarizado con conexión a tierra. Un enchufe polarizado tiene dos espigas, una más ancha que la otra. Un enchufe con conexión a tierra tiene dos espigas iguales y una tercera espiga que sirve para la conexión a tierra. La espiga ancha, o la tercera espiga, sirven para su seguridad. Si el enchufe suministrado no encaja en el tomacorriente, consulte con un electricista para reemplazar el tomacorriente obsoleto.

**Aviso!** Não anule a finalidade da segurança da ficha polarizada ou do tipo ligação terra. Uma ficha polarizada tem duas lâminas sendo uma mais larga do que a outra. Uma ficha do tipo de ligação à terra tem duas lâminas e um terceiro terminal de ligação à terra. A lâmina larga ou o terceiro terminal são fornecidos para sua segurança. Se a ficha fornecida não couber na sua tomada, consulte um electricista para a substituição da tomada obsoleta.

**Avviso!** Non compromettere la sicurezza della spina polarizzata o con messa a terra. Una spina polarizzata ha due spinotti, di cui uno più largo. Una spina con messa a terra ha due spinotti e un terzo polo per la messa a terra. Lo spinotto largo o il terzo polo sono forniti per motivi di sicurezza. Se la spina fornita non si inserisce nella presa di corrente, contattare un elettricista per la sostituzione della presa obsoleta.



**Warning!** Disconnect the external AC power supply line cord(s) from the mains power before moving the unit.

**Avertissement!** Retirez le ou les cordons d'alimentation en CA de la source d'alimentation principale lorsque vous déplacez l'appareil.

**Warnung!** Trennen Sie die Wechselstrom-Versorgungskabel vom Netzstrom, bevor Sie das Gerät verschieben.

**¡Advertencia!** Cuando mueva la unidad desenchufe de la red eléctrica el/los cable(s) de la fuente de alimentación CA tipo brick.

**Advertência!** Remova os cabos CA de alimentação brick da rede elétrica ao mover a unidade.

**Avvertenza!** Scollegare il cavo dell'alimentatore quando si sposta l'unità.



**Warning!** Since the Mains plug is used as the disconnection for the device, it must remain readily accessible and operable.

**Avertissement!** Puisque la prise principale est utilisée pour débrancher l'appareil, elle doit rester aisément accessible et fonctionnelle.

**Warnung!** Da der Netzstecker als Trennvorrichtung dient, muss er stets zugänglich und funktionsfähig sein.

**¡Advertencia!** Puesto que el enchufe de la red eléctrica se utiliza como dispositivo de desconexión, debe seguir siendo fácilmente accesible y operable.

**Aviso!** Dado que a ficha principal é utilizada como a desconexão para o dispositivo, esta deve manter-se prontamente acessível e funcional.

**Avviso!** Poiché il cavo di alimentazione viene usato come dispositivo di sconnessione, deve rimanere prontamente accessibile e operabile.



**Warning!** Protect the power cord from being walked on or pinched particularly at plugs, convenience receptacles, and the point where they exit from the device.

**Avertissement!** Protégez le cordon d'alimentation pour que l'on ne marche pas dessus ou qu'on le pince, en particulier au niveau des prises mâles, des réceptacles de convenance, et à l'endroit où il sort de l'appareil.

**Warnung!** Vermeiden Sie, dass auf das Netzkabel getreten oder das Kabel geknickt wird, insbesondere an den Steckern, den Steckdosen und am Kabelausgang am Gerät.

**¡Advertencia!** Proteja el cable de energía para que no se le pise ni apriete, en especial cerca del enchufe, los receptáculos de conveniencia y el punto del que salen del equipo.

**Aviso!** Proteja o cabo de alimentação de ser pisado ou de ser comprimido particularmente nas fichas, em tomadas de parede de conveniência e no ponto de onde sai do dispositivo.

**Avviso!** Proteggere il cavo di alimentazione in modo che nessuno ci cammini sopra e che non venga schiacciato soprattutto in corrispondenza delle spine e del punto in cui esce dal dispositivo.

# Warranty and Liability Information

---

AJA VIDEO SYSTEMS, INC.

## Limited Warranty on Hardware

---

AJA Video Systems, Inc. (AJA Video) warrants that the hardware product, not including storage modules or software components, will be free from defects in materials and workmanship for a period of three (3) years from the date of purchase. AJA Video warrants that the storage modules provided as part of the hardware product will be free from defects in materials and workmanship for a period of one year from the date of purchase. AJA Video provides a separate software warranty as part of the license agreement applicable to software components.

If a hardware product or storage module (hereafter, a “product”) proves to be defective during the applicable warranty period, AJA Video, at its option, will either repair the defective product without charge for parts and labor, or will provide a replacement in exchange for the defective product.

To obtain service under this warranty, the Customer must notify AJA Video of the defect before expiration of the warranty period and make suitable arrangements for the performance of service by contacting AJA Video support through the channels set forth on the support contacts web page at <http://www.aja.com/support>. Except as stated, the Customer shall bear all shipping, packing, insurance and other costs, excluding parts and labor, to effectuate repair. Customer shall pack and ship the defective product to a service center designated by AJA Video, with shipping charges prepaid. AJA Video shall pay to return the product to Customer but only if to a location within the country in which the AJA Video service center is located.

This warranty shall not apply to any defect, failure or damage caused by negligent, inadequate or improper use, handling or maintenance. Without limiting the foregoing, AJA Video shall not be obligated to furnish service under this warranty or repair any damage or malfunction a) resulting from attempts by personnel other than AJA Video representatives to install, repair or service the product, b) resulting from improper use or connection to incompatible equipment, c) caused by the use of non-AJA Video parts or supplies, d) if the product has been modified or integrated with other products when the effect of such a modification or integration increases the time or difficulty of servicing the product, or e) resulting from being dropped or otherwise subjected to undue force, exposure to moisture or other corrosive or conductive substances, exposure to strong magnetic fields, use with improperly regulated power supplies, exposure to electric shock, use in temperatures outside the specified operating range, or otherwise failing to treat the product in accordance with the standard of care appropriate to sensitive and delicate electronic equipment.

EXCEPT AS STATED ABOVE, AJA VIDEO AND ITS VENDORS DISCLAIM IN THEIR ENTIRETY ALL OTHER WARRANTIES, EXPRESS OR IMPLIED, INCLUDING WITHOUT LIMITATION ALL WARRANTIES OF MERCHANTABILITY OR FITNESS FOR A PARTICULAR PURPOSE. AJA VIDEO'S RESPONSIBILITY TO REPAIR OR REPLACE TIMELY REPORTED DEFECTIVE PRODUCTS IS THE WHOLE AND EXCLUSIVE REMEDY CUSTOMER IS PROVIDED WITH RESPECT TO HARDWARE PRODUCTS AND THEIR STORAGE MODULES. SOME JURISDICTIONS DO NOT ALLOW THE EXCLUSION OF IMPLIED WARRANTIES OR LIMITATIONS ON APPLICABLE STATUTORY RIGHTS OF A CONSUMER, SO SOME OR ALL OF THE TERMS OF THIS PARAGRAPH MAY NOT APPLY TO YOU.

THE PRODUCT IS NOT INTENDED, STATED, OR WARRANTED TO OPERATE UNINTERRUPTED OR ERROR-FREE. YOU UNDERSTAND AND ACKNOWLEDGE THAT THE PRODUCT IS NOT INTENDED TO BE USED AS THE SOLE OR PRIMARY DATA SOURCE OR TARGET FOR CRITICAL DATA, AND THAT IT IS YOUR RESPONSIBILITY TO IMPLEMENT REDUNDANT CAPTURE AND BACKUP SYSTEMS AS APPROPRIATE.

## Limitation of Liability

---

Under no circumstances shall AJA video BE LIABLE IN ANY WAY FOR ANY LOST, CORRUPTED OR DESTROYED DATA, FOOTAGE OR WORK, OR FOR ANY OTHER INDIRECT, SPECIAL, INCIDENTAL OR CONSEQUENTIAL DAMAGES OR LOST PROFITS, OR FOR ANY THIRD PARTY CLAIM, IN CONNECTION WITH THE PRODUCT, WHETHER RESULTING FROM DEFECTS IN THE PRODUCT, SOFTWARE OR HARDWARE FAILURE, OR ANY OTHER CAUSE WHATSOEVER, EVEN IF AJA VIDEO HAS BEEN ADVISED OF THE POSSIBILITY OF SUCH DAMAGES. AJA VIDEO'S LIABILITY IN CONNECTION WITH THE PRODUCT SHALL UNDER NO CIRCUMSTANCES EXCEED THE PURCHASE PRICE PAID FOR THE PRODUCT. The foregoing limitations apply even if any remedy set forth in this LIMITED WARRANTY fails of its essential purpose. SOME JURISDICTIONS DO NOT ALLOW THE LIMITATION OF LIABILITY FOR PERSONAL INJURY, OR OF INCIDENTAL OR CONSEQUENTIAL DAMAGES, SO SOME OR ALL OF THE TERMS OF THIS PARAGRAPH MAY NOT APPLY TO YOU.

## Governing Law and Language; Your Rights.

---

This limited warranty is the only warranty provided by AJA Video on the hardware product. It supersedes all prior or contemporaneous understandings regarding such subject matter. No amendment to or modification of this warranty will be binding unless in writing and signed by AJA Video. The laws of the State of California, USA will govern this warranty and any dispute arising from it. Any translation of this Agreement is intended for convenience and to meet local requirements and in the event of a dispute between the English and any non-English versions, the English version of this warranty will govern. This limited warranty gives you specific legal rights and you may have other rights that vary from jurisdiction to jurisdiction, some of which are noted above.

# Index

---

## Symbols

- 2SI Mode 19
- 2-Wire Mode 19
- 3G Transport 28
- 3rd-Party Plugins 6
- 4K Transport 28
- 4K/UltraHD Transport Modes 18
- 4-Link to 2-Link Switching 34
- 4-Wire Mode 19
- Single-Wire 12G Mode 20
- 12V Power Connector 11

## A

- AJA Control Panel 6
  - User Interface 14
- AJA Control Room 6
- AJA Input 39
- AJA Software & Utilities 6
- AJA Support 2
- AJA System Test 6
- Alpha Channel 42
- Analog Audio 11
- Analog Audio Monitor Level 35
- Analog Audio Pinouts 52
- Ancillary Data 34
- Audio Ch 29
- Audio Ch 3/4 Swap 30
- Audio Input 26
- Audio Level Meters 13
- Audio Mixer Screen 36
- Audio Monitor 35
- Audio Monitoring 20
- Audio Monitoring Routing Diagram 21
- Audio Out 42
- Audio Setup Screen 35

## B

- Black Burst 11
- Block Diagram Area 15

## C

- Cable Connections 10
- Capture Monitor Mode Screen 38
- Ch 3/4 Swap 30
- Ch Map 26
- Ch Map 26
- Color Space 27, 30, 33
- Controlling Application 16
- Control Panel 6
  - Framebuffer 15
  - Input/Output Icon 15
  - Primary Format 15
  - UI Colors 15
  - User Interface 14
- Control Room 6
- Control Screen 22

- Cross-Conversion 25
- Custom LUT Controls 43

## D

- DE-9 Connector 11
- Default Output 22
- Default Preferences 16
- Delete Preset 47
- Digital Primaries 32
- Display Mastering Luminance 32
- Downstream Keyer 41
- DS Keyer Screen 41

## E

- EOTF 31
- Erase all Prefs 48
- Ext. Color 31

## F

- Features 5
- Firmware Screen 48
- Follow Input 24
- Foreground Pre-Multiplied 42
- Format 24
- Format Screen 24
- Frame Buffer Over Matte 42
- Frame Buffer Over Video In 42
- Freerun 23

## G

- Gamma 34
- Genlock 23
- Global Preference 17
- Global Preference File Location 17
- Graphic File 42
- Graphic File Display 23
- Graphic Over Frame Buffer 42
- Graphic Over Matte 42
- Graphic over Video In 42

## H

- HDMI HDR Screen 31
- HDMI Input 10, 30
- HDMI Output 10, 29
- HDMI Screen 29
  - 4K Mode 50
- HDR Mode 31
- Hold Last App 22
- Horiz and Vert Timing 23
- Host Audio 40
- House Sync 23

## I

- Info Screen 49
- Input/Output Icon 15
- Input/Output Icons 15

- Input Passthrough 22
- Input Select Screen 25
- Installation Overview 9

## K

- Keyed Video 42
- Keyer
  - Downstream 41

## L

- Load Preset 47
- Local Preference 17
- Local Preference File 17
- LTC Input 11
- LTC/Ref 26
- LUT File 43, 44
- LUT File Format Specification 45
- LUT Gain and Offset Controls 44
- LUT Screen 43
- LUT Type 43

## M

- Machine Control 11
- Main App 39
- Matte Color 42
- Maximum Content Light Level (CLL) 32
- Maximum Frame Average Light Level (FALL) 32
- Monitor Gain Control 13
- Monitor Output 13

## O

- Overview 5

## P

- Packing Contents 7
- Pinouts
  - Analog Audio 52
- Pixel Format 25
- Playback Monitor Mode Screen 39
- Playback Source Selection 39
- Playback Timing 23
- Power LED 14
- Preference 16
- Preference File Location
  - Default Global 17
- Preset
  - Delete 47
  - Load 47
  - Save 47
- Preset Files Storage Location 16, 47
- Presets 16
- Presets Screen 47
- Primary Format 15
- Progressive Pref 33
- Protocol 30

## Q

- Quadrant 5
- Quadrant Mode 19

## R

- Reference Video 11
  - Match Primary Format 11
- Reference Video Signal 11
- Ref In 23
- Reset to Default 48
- RGB Range 25, 27, 30
- RP 188 46
- RS-422 11

## S

- Save Preset 47
- SDI Color Sp 26
- SDI HD/SD Output 10
- SDI Input Quad Swap 34
- SDI I/O 10
- SDI Output Quad Swap 34
- SDI Output Screen 27
- SDI RGB Rng 26
- Single-Wire Mode 20
- Snapshot 47
- Software Installation 11
- Source
  - Video Input 26
- Source Gain 40
- System Requirements 7
- System Test 6

## T

- Technical Support 2
- Test Pattern 22, 23
- Thunderbolt 3 10
- Timecode Screen 45
- Timing
  - Horiz 23
  - Vert 23
- Transferring Saved Presets 47
- Two Sample Interleave 5

## U

- Uploading Custom User LUT file 44
- User Bits 46

## V

- VANC Checkbox 34
- Variable Framerate (VFR) 46
- Video+Key 27
- Video In 23
- Video Input 26
- Video Path 15
- Video Setup Screen 33