

MHUB PRO (8x8) 70

Product code: **MHUB4KPRO88**
HDMI / HDBaseT Matrix System



Connectivity-rich professional series 8x8 HDMI/HDBT+mirror matrix system with long-range video (4K 70m/1080p 100m), network extension and powerful control options. A 'one-wire' UHD/4K-capable whole-home AV hub, that hides home entertainment devices centrally and makes them universally available on every display.

All easily-controlled via the free uControl app or with the hands-free convenience of Alexa voice control - also features remote monitoring and management via HDA Cloud, designed to reduce the necessity for callouts and site visits. Capable of carrying Ultra HD 4K + support for HDR and Dolby Vision®. Integration needs are well catered for, with each of the eight display outputs featuring both multichannel digital audio extraction and stereo downmixing, making for easy integration with multizone amplifiers or audio matrices.

FEATURES

HDMI® 2.0 features supported up to 10.2Gbps
Backlit fade in/out touch panel controls
All display receivers powered via PoH
Web GUI for easy config and setup (MHUB-OS)
Remote system monitoring and management (HDA Cloud)
Advanced EDID management
Supports HDCP 2.2 Ultra HD 4K 24/30Hz 4:2:2 (HDR10) or 60Hz 4:2:0 (HDR 8bit) + support for Dolby Vision and HLG.
Supports all current audio formats up to and including Dolby Atmos® and DTS:X®
Multichannel audio extraction via digi-coax, or audio downmix via stereo jack
Easy and instant integration with MHUB AUDIO
4K>1080 down/up-scaling receiver option available

SPECIFICATIONS

Form factor	19"/2U aluminum rack-mountable unit
Inputs x outputs	8 HDMI x 8 RJ45 HDBaseT + 8 mirrored HDMI
Transmission tech.	HDBaseT Class A and HDMI
Video bandwidth	340MHz clock / 10.2Gbps data
ESD protection	± 8kV (air-gap discharge) ± 4kV (contact discharge)
Hub control	Web GUI, IR, TCP/IP, RS232, App, Alexa
App control	Full control over sources, matrix hub & display functions.
Device weight	Hub 4600g RX 192g
Package weight	8000g
Dimensions (W/D/H)	Hub 440 / 380 / 90mm (without feet) RX 163 / 94 / 19mm
Operating temperature	32°F to 104°F (0°C to 40°C)
Storage temperature	-4°F to 140°F (-20°C to 60°C)
Relative humidity	20~90 % RH (non-condensing)
Power consumption	30W (max) 0.5W (standby)
Guarantee	3/4-year guarantee (Cloud registration required)

CONTROL

Universal App Control
 Full control of your Matrix, Source and Displays via HDANYWHERE'S free app uControl

Native Amazon Alexa Voice Control
 All MHUBs support Amazon Alexa natively, allowing full control of your AV system via voice







Third Party Control
 All MHUBs offer IP and RS232 integration as standard, drivers are available for all major control system brands

IR Remote Control
 Matrix packaged with 2 remote controls, one discreet and one contextual

MHUB PRO 70

Product Code: MHUBPRO8870

LEGEND

-  Ethernet Cable
-  HDMI Cable
-  Digi-Coax Cable
-  IR Receiver
-  HDBASET
-  IR Receiver
-  IR Signal

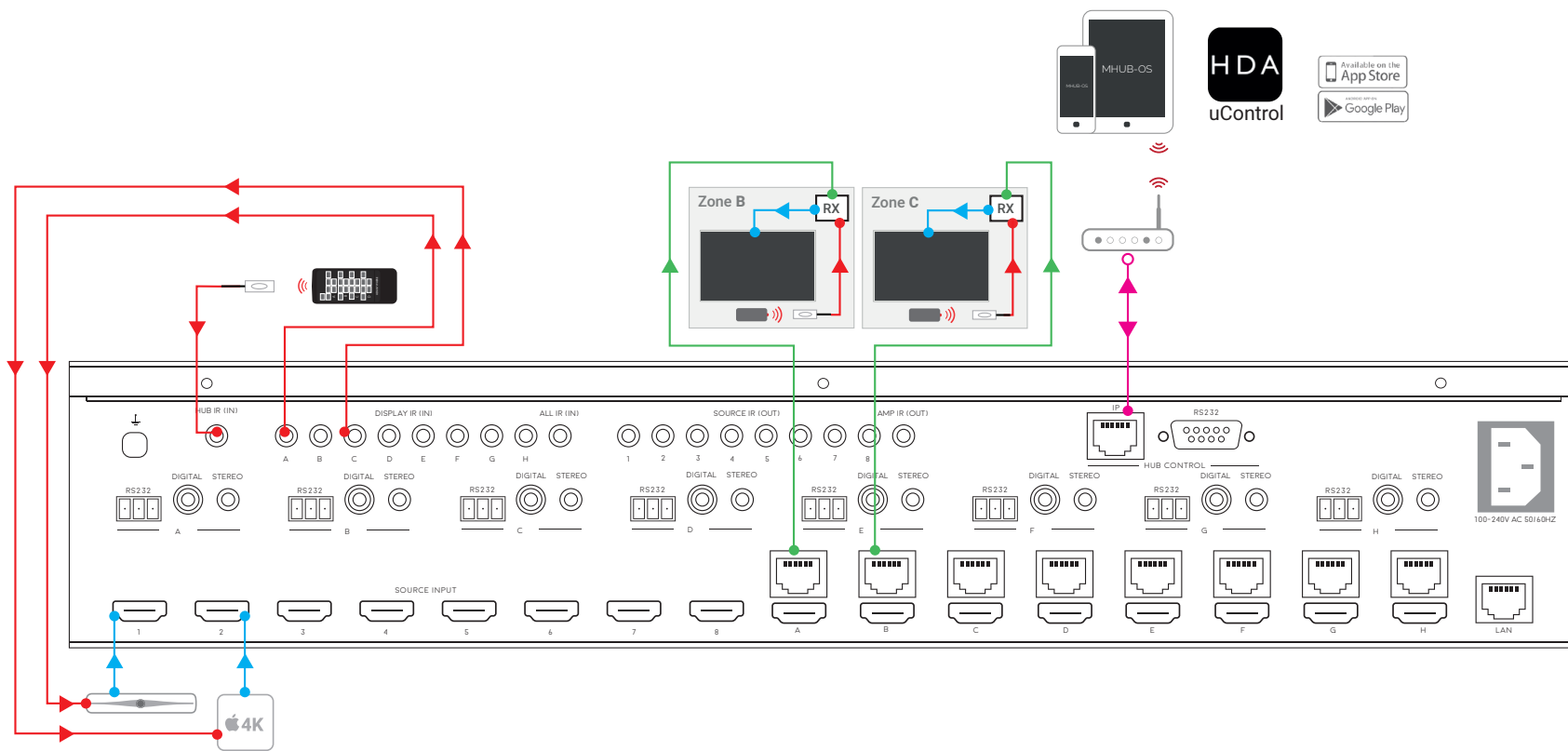

HDANYWHERE.COM

Hereby, HDANYWHERE™ declares that this HDMI connectivity device is in compliance with the essential requirements and other relevant provisions of the following Directives: 2006/95/EC (LVD Directive); 2004/108/EC (EMC Directive); 999/5/EC (R&TTE Directive). HD CONNECTIVITY LTD, trading as HDANYWHERE registered in England and Wales. Company No: 06046737 Registered office: Unit 23 Link Business Centre, Link Way, Malvern, Worcestershire, WR14 1UG. Contact: support@hdanywhere.com Tel: 00441684575324